

Occhio

price overview
2023|11

culture of light

series

X

system



Mito raggio/Mito largo	6-7
Mito sospeso/Mito sospeso move	8-13
Mito cosmo	14-15
Mito aura	16-17
Mito soffitto	18-19
Mito sfera	20-21



Mito raggio lusso/Mito largo lusso	34-37
Mito sospeso lusso	38-41
Mito aura lusso	42-45
Mito soffitto lusso	46-51



Mito terra	54-57
Mito volo	58-65
Mito alto	66-69
Mito alto side	70-73



Gioia	84-85
-------	-------



Taglio	90-91
--------	-------

L



Sento	96-107
-------	--------



Sento sospeso	114-117
---------------	---------



Più/Più R	124-139
-----------	---------

M



io spotlights	152-159
---------------	---------



io 3d	166-169
-------	---------



lui spotlights	176-185
----------------	---------



lui 3d	192-195
--------	---------



lei 3d	202-205
--------	---------

E



Sito	212-217
------	---------

C



Occhio air	226-227
------------	---------

X series

Mito

The myth of light. Sensual, mythical, aesthetic – Mito is the perfect symbiosis of design, innovation and the highest quality of light.

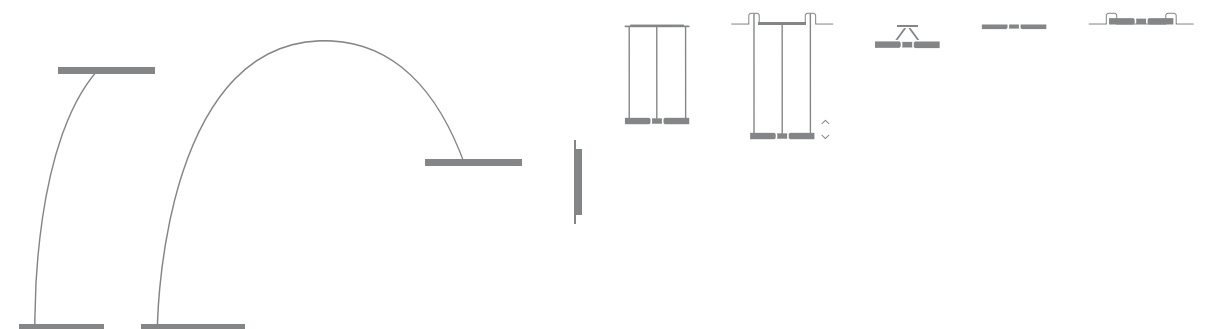

Mito
arc luminaires



raggio

height 205 cm
ø head 60 cm, 60 W (3330 lm)

Ⓢ can be synced via Occhio air



largo

height head 130 cm, 145 cm, 160 cm (adjustable)
resulting total height ca. 210–240 cm
ø head 60 cm, 60 W (3330 lm)

Ⓢ can be synced via Occhio air

colors	4.184,87
materials	+386,55
phantom/black phantom	+579,83

colors	5.865,55
materials	+386,55
phantom/black phantom	+579,83

control

features

»color tune«, »up/down fading«, switch- and dimmable via »touchless control«, »body sensor« (only raggio), and Occhio air (included)

Occhio air 

Bluetooth control integrated in power supply. Features via Occhio air app or »air« controller (optional) controllable, no external dimming

options

light source

high color LED CRI 95

2700 K–4000 K **Ⓢ 2200 K–3500 K »x-tra warm«**
+504,20

lighting effects

 flood

 wide

surfaces

head/body+base colors

matt white/matt white 

matt black/matt black 

matt silver/matt black 

matt gold/matt white 

matt gold/matt black 

materials/phantom/black phantom

rose gold/matt black 

bronze/matt black 

phantom/matt black 

black phantom/matt black 

The surfaces rose gold, bronze, phantom and black phantom may differ slightly from other product lines.

further options - accessories for Occhio air from page 226

These and further options can be configured at **Occhio Digital Order System (DOS)**

further information - technical data and information on control view pages 30–31

Mito

suspended luminaires sospeso 40



flat



pure



up



due

fix	variable	fix	variable	fix	variable	fix	variable
pendant length adjustable during mounting, max. 350 cm		flush ceiling-mounted installation in hollow ceiling, incl. mounting board ø 40 cm, 40 W (2220 lm) incl. remote converter		for surface-mounted installation ø 40 cm, 40 W (2220 lm) through-wiring possible		for surface-mounted installation ø 40 cm, 2 x 40 W (2 x 2220 lm) through-wiring possible	
continuous height adjustment 50–200 cm	Ⓢ can be synced via Occhio air		Ⓢ can be synced via Occhio air	Ⓢ can be synced via Occhio air		Ⓢ can be synced via Occhio air	
colors	1.710,92	2.460,50	2.835,29	1.961,34	2.336,13	4.189,92	4.939,50
materials	+252,10			+252,10		+504,20	
phantom/black phantom	+378,15			+378,15		+756,30	
	Ⓢ special lengths up to 500 cm possible (surcharge per head +319,33, discountable)			Ⓢ special lengths up to 500 cm possible (surcharge per head +319,33, discountable)		Ⓢ special lengths up to 500 cm possible (surcharge per head +319,33, discountable)	

sospeso 60



flat



pure



up

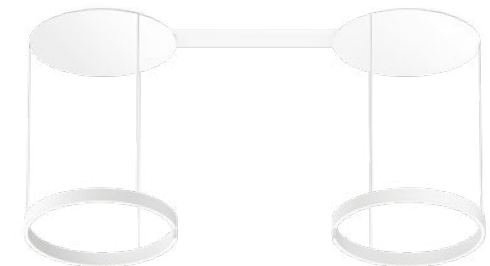

due

fix	variable	fix	variable	fix	variable	fix	variable
pendant length adjustable during mounting, max. 350 cm		flush ceiling-mounted installation in hollow ceiling, incl. mounting board ø 60 cm, 60 W (3330 lm) incl. remote converter		for surface-mounted installation ø 60 cm, 60 W (3330 lm) through-wiring possible		for surface-mounted installation ø 60 cm, 2 x 60 W (2 x 3330 lm) through-wiring possible	
continuous height adjustment 50–200 cm	Ⓢ can be synced via Occhio air		Ⓢ can be synced via Occhio air	Ⓢ can be synced via Occhio air		Ⓢ can be synced via Occhio air	
colors	2.327,73	3.334,45	3.721,01	2.705,88	3.092,44	5.771,43	6.544,54
materials	+386,55			+386,55		+773,11	
phantom/black phantom	+579,83			+579,83		+1.159,66	
	Ⓢ special lengths up to 500 cm possible (surcharge per head +319,33, discountable)			Ⓢ special lengths up to 500 cm possible (surcharge per head +319,33, discountable)		Ⓢ special lengths up to 500 cm possible (surcharge per head +319,33, discountable)	

control	features	Mito set box	Mito »air« box	Mito DALI box
	»color tune«, »up/down fading«, switch- and continuously dimmable via »touchless control« (can be deactivated) and Occhio air (optional)	features adjustable via »touchless control« (no external dimming). Alternative: color temperature 2700 K/3000 K/3500 K/4000 K and »up/down fading« adjustable, dimmable via trailing-edge phase cut dimmer (not for »x-tra warm«)	Bluetooth control integrated in cover/canopy. Features via Occhio air app or »air« controller (optional) controllable (no external dimming)	version for building control system via DALI (no »touchless control«)
			+82,35	+82,35

options	light source	lighting effects	surfaces	head colors	materials/phantom/black phantom	canopy
	high color LED CRI95 2700 K–4000 K with set, »air« or DALI box	room diffuse narrow table flood wide		matt white matt black matt silver matt gold	rose gold bronze phantom black phantom	matt white matt black*
	Ⓢ 2200 K–3500 K »x-tra warm« only with »air« or DALI box surcharge per head ø 40 + 336,13 ø 60 + 504,20					

*canopy in matt black (surcharge per head ø 40 + 134,45; ø 60 + 201,68; flat Version 67,23) Ⓢ
The surfaces rose gold, bronze, phantom and black phantom may differ slightly from other product lines.

further options	further information
- accessories for Occhio air from page 226	- technical data, information on control and mounting options view pages 22–31

Mito

suspended luminaires sospeso move 40



move up



move pure

»magic move« electrical height adjustment
50–200 cm

for surface-mounted installation
incl. power supply
ø 40 cm, 40 W (2220 lm)
through-wiring possible

☺ can be synced via Occhio air

»magic move« electrical height adjustment
50–200 cm

for flush ceiling-mounted installation
incl. mounting board and power supply
ø 40 cm, 40 W (2220 lm)
through-wiring possible

☺ can be synced via Occhio air

colors	2.924,37
materials	+252,10
phantom/black phantom	+378,15

sospeso move 60



move up



move pure

»magic move« electrical height adjustment
50–200 cm

for surface-mounted installation
incl. power supply
ø 60 cm, 60 W (3330 lm)
through-wiring possible

☺ can be synced via Occhio air

»magic move« electrical height adjustment
50–200 cm

for flush ceiling-mounted installation
incl. mounting board and power supply
ø 60 cm, 60 W (3330 lm)
through-wiring possible

☺ can be synced via Occhio air

colors	3.680,67
materials	+386,55
phantom/black phantom	+579,83

control	features
	»magic move«, »color tune«, »up/down fading«, switch- and continuously dimmable via »touchless control« (can be deactivated) and Occhio air (included)

Occhio air (inclusive) 

Bluetooth control integrated in canopy, features controllable via Occhio air app or »air« controller (optional) (no external dimming)

options	light source	lighting effects	surfaces	head colors	materials/phantom/black phantom	canopy
	high color LED CRI 95 2700 K–4000 K ☺ 2200 K–3500 K »x-tra warm« ø 40 + 336,13 ø 60 + 504,20	room diffuse narrow table flood wide		matt white matt black matt silver matt gold	rose gold bronze phantom black phantom	matt white matt black*

*canopy in matt black (surcharge per head ø 40 + 134,45; ø 60 + 201,68) ☺
The surfaces rose gold, bronze, phantom and black phantom may differ slightly from other product lines.

further options - accessories for Occhio air from page 226

These and further options can be configured at
Occhio Digital Order System (DOS)

further information - technical data, information on control and mounting options view pages 22–31

Mito

suspended luminaires cosmo move 40



cosmo move

»magic move« electrical height adjustment 0–200 cm
luminaire can be retracted flush with the ceiling

flush ceiling-mounted installation in hollow ceiling
incl. mounting board and external power supply
ø 40 cm, 40 W (2220 lm)
through-wiring possible

Ⓜ can be synced via Occhio air

colors	3.596,64
materials	+252,10
phantom/black phantom	+378,15

cosmo move 60



cosmo move

»magic move« electrical height adjustment 0–200 cm
luminaire can be retracted flush with the ceiling

flush ceiling-mounted installation in hollow ceiling
incl. mounting board and external power supply
ø 60 cm, 60 W (3330 lm)
through-wiring possible

Ⓜ can be synced via Occhio air

colors	4.521,01
materials	+386,55
phantom/black phantom	+579,83

control	features »magic move«, »color tune«, »up/down fading«, switch- and continuously dimmable via »touchless control« (can be deactivated) and Occhio air (included)	Applications glow pure ceiling room table	Occhio air (inclusive)  Bluetooth control integrated in canopy, features controllable via Occhio air app or »air« controller (optional) (no external dimming)
----------------	---	---	--

options	light source high color LED CRI95 2700 K–4000 <input type="radio"/> 2200 K–3500 K »x-tra warm« <input checked="" type="radio"/> ø 40 + 336,13 ø 60 + 504,20	lighting effects room up: diffuse down: narrow table up: flood down: wide	surfaces	head colors matt white matt black matt silver matt gold	materials/phantom/black phantom rose gold bronze phantom black phantom	light channel matt white gold matt
----------------	--	--	-----------------	--	---	---

*canopy in matt black (surcharge per head ø 40 + 134,45; ø 60 + 201,68) Ⓜ
The surfaces rose gold, bronze, phantom and black phantom may differ slightly from other product lines.

further options	- accessories for Occhio air from page 226	These and further options can be configured at Occhio Digital Order System (DOS)	further information	- technical data, information on control and mounting options view pages 22–31
------------------------	--	---	----------------------------	--

Mito

recessed ceiling luminaires
cosmo piano 20



cosmo piano

flush ceiling-mounted installation in hollow ceiling
incl. mounting board and external power supply
ø 20 cm, 20 W (850lm), through-wiring possible

colors	1.243,70
materials	+117,65
phantom/black phantom	+176,47

cosmo piano 40



cosmo piano

flush ceiling-mounted installation in hollow ceiling
incl. mounting board and external power supply
ø 40 cm, 40 W (1700lm), through-wiring possible

colors	1.663,87
materials	+252,10
phantom/black phantom	+378,15

cosmo piano 60





cosmo piano

flush ceiling-mounted installation in hollow ceiling
incl. mounting board and external power supply
ø 60 cm, 60 W (2400lm), through-wiring possible

colors	2.420,17
materials	+386,55
phantom/black phantom	+579,83

control	features »color tune«, »up/down fading«, switch- and continuously dimmable via Occhio air (included)
----------------	--

Applications
 glow  pure

Occhio air (inclusive) 
Bluetooth control integrated in canopy, features controllable via Occhio air app or »air« controller (optional) (no external dimming)

options	light source high color LED CRI95 2700 K–4000 K <input checked="" type="radio"/> 2200 K–3500 K »x-tra warm« ø 20 + 210,08 ø 40 + 336,13 ø 60 + 504,20
----------------	--

lighting effects	
room up: diffuse down: narrow 	table up: flood down: wide 

surfaces	head colors matt white matt black matt silver matt gold	materials/phantom/black phantom rose gold bronze phantom black phantom	light channel matt white gold matt
-----------------	--	---	---

*canopy in matt black (surcharge per head ø 40 + 134,45; ø 60 + 201,68) 
The surfaces rose gold, bronze, phantom and black phantom may differ slightly from other product lines.

further options - accessories for Occhio air from page 226

These and further options can be configured at **Occhio Digital Order System (DOS)**

further information - technical data, information on control and mounting options view pages 22–31

Mito

wall and ceiling luminaires
aura 40

aura 60

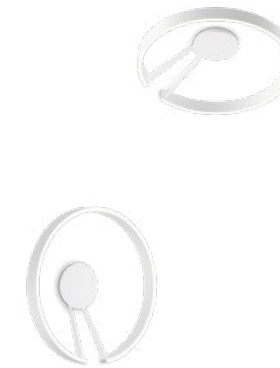

aura

for surface-mounted installation, incl. power supply
ø 40 cm, H 13,5 cm, 40 W (2310 lm)
Ⓢ can be synced via Occhio air

aura

for surface-mounted installation, incl. power supply
ø 60 cm, H 13,5 cm, 60 W (3460 lm)
Ⓢ can be synced via Occhio air

colors	1.663,87
materials	+252,10
phantom/black phantom	+378,15

2.302,52
+386,55
+579,83

control	features »color tune«, »up/down fading«, switch- and continuously dimmable via »touchless control« (can be deactivated) and Occhio air (optional)	Mito set box features adjustable via »touchless control« (no external dimming). Alternative: color temperature 2700 K/3000 K/3500 K/4000 K and »up/down fading« adjustable, dimmable via trailing-edge phase cut dimmer (not for »x-tra warm«)	Mito »air« box  Bluetooth control integrated in cover/canopy. Features via Occhio air app or »air« controller (optional) controllable (no external dimming)	Mito DALI box version for building control system via DALI (no »touchless control«)
			+82,35	+82,35

options	light source high color LED CRI95 2700 K-4000 K with set, »air« or DALI box Ⓢ 2200 K-3500 K »x-tra warm« only with »air« or DALI box ø 40 +336,13 ø 60 +504,20	lighting effects ceiling diffuse narrow ceiling diffuse wide wall diffuse/wide	surfaces	head colors matt white  matt black  matt silver  matt gold 	materials/phantom/black phantom rose gold  bronze  phantom  black phantom 	canopy/body matt white  matt black 
				The surfaces rose gold, bronze, phantom and black phantom may differ slightly from other product lines.		

further options	- accessories for Occhio air from page 226	These and further options can be configured at Occhio Digital Order System (DOS)	further information	- technical data, information on control and mounting options view pages 22-31
------------------------	--	---	----------------------------	--

Mito

wall and ceiling luminaires
soffitto 20

soffitto 40



flat

for hollow ceiling
ø 20 cm, 20 W (850 lm)
incl. remote converter



up

for surface-mounted installation
ø 20 cm, 20 W (850 lm)
through-wiring possible



flat

for hollow ceiling
ø 40 cm, 40 W (1700 lm)
incl. remote converter



up

for surface-mounted installation
ø 40 cm, 40 W (1700 lm)
through-wiring possible

colors	636,97
materials	+100,84
phantom/black phantom	+151,26

756,30

colors	946,22
materials	+151,26
phantom/black phantom	+226,89

1.109,24

soffitto 60



flat

for hollow ceiling
ø 60 cm, 60 W (2400 lm)
incl. remote converter



up

for surface-mounted installation
ø 60 cm, 60 W (2400 lm)
through-wiring possible

colors	1.373,11
materials	+235,29
phantom/black phantom	+352,94

1.613,45

control **features**
»color tune«, switch- and continuously dimmable
via Occhio air (optional)

Mito set box
color temperature 2700 K/3000 K/3500 K/4000 K
adjustable, dimmable via trailing-edge phase
cut dimmer (not for »x-tra warm«)

Mito »air« box 
Bluetooth control integrated in cover/canopy. Features via Occhio air
app or »air« controller (optional) controllable (no external dimming)

Mito DALI box
version for building control system via DALI
(not for soffitto 20 up)





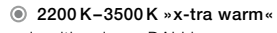
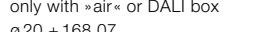
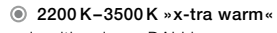
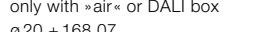
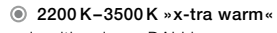
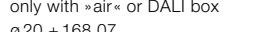

























+82,35

+82,35

options	light source high color LED CRI95					
	<table border="0"> <tr> <td>2700 K–4000 K with set, »air« or DALI box</td> <td>  </td> </tr> <tr> <td></td> <td>  </td> </tr> <tr> <td></td> <td> <p>Ⓢ 2200 K–3500 K »x-tra warm« only with »air« or DALI box ø 20 + 168,07 ø 40 + 252,10 ø 60 + 336,13</p> </td> </tr> </table>	2700 K–4000 K with set, »air« or DALI box				
2700 K–4000 K with set, »air« or DALI box						
						
	<p>Ⓢ 2200 K–3500 K »x-tra warm« only with »air« or DALI box ø 20 + 168,07 ø 40 + 252,10 ø 60 + 336,13</p>					

lighting effects									
<table border="0"> <tr> <td>ceiling</td> <td>ceiling</td> <td>wall to wall</td> </tr> <tr> <td>narrow</td> <td>wide</td> <td>wide</td> </tr> <tr> <td></td> <td></td> <td></td> </tr> </table>	ceiling	ceiling	wall to wall	narrow	wide	wide			
ceiling	ceiling	wall to wall							
narrow	wide	wide							
									

surfaces

head colors	materials/phantom/black phantom														
<table border="0"> <tr> <td></td> <td>rose gold</td> <td></td> </tr> <tr> <td></td> <td>bronze</td> <td></td> </tr> <tr> <td></td> <td>phantom</td> <td></td> </tr> <tr> <td></td> <td>black phantom</td> <td></td> </tr> </table>		rose gold			bronze			phantom			black phantom		<table border="0"> <tr> <td></td> </tr> <tr> <td></td> </tr> </table>		
	rose gold														
	bronze														
	phantom														
	black phantom														
															
															

*canopy in matt black (surcharge per head ø 20 + 67,23; ø 40 + 134,45; ø 60 + 201,68; flat Version + 67,23) Ⓢ
The surfaces rose gold, bronze, phantom and black phantom may differ slightly from other product lines.

further options - accessories for Occhio air from page 226

These and further options can be configured at
Occhio Digital Order System (DOS)

further information

- technical data, information on control and mounting options view pages 22–31

Mito
mirror luminaires
sfera 40



sfera



sfera su



sfera corda

ø 40 cm,
20 W (800 lm)

surface-mounted including mirror,
including power supply

Ⓢ can be synced via Occhio air

mounting on a mirror, power supply
behind the mirror or in recess,
incl. power supply

Ⓢ can be synced via Occhio air

surface-mounted including mirror,
including power supply and
cable (3,5 m) with plug

Ⓢ can be synced via Occhio air

colors 1.294,12
materials +168,07
phantom/black phantom +252,10
surcharge mirror
grey tinted +67,23

cable extension (5 m)
for power supply unit

1.073,95
+31,93

surcharge mirror
grey tinted

1.379,83
+168,07
+252,10
+67,23

sfera 60



sfera



sfera su



sfera corda

ø 60 cm,
40 W (1600 lm)

surface-mounted including mirror,
including power supply

Ⓢ can be synced via Occhio air

mounting on a mirror, power supply
behind the mirror or in recess,
incl. power supply

Ⓢ can be synced via Occhio air

surface-mounted including mirror,
including power supply and
cable (3,5 m) with plug

Ⓢ can be synced via Occhio air

colors 1.798,32
materials +252,10
phantom/black phantom +378,15
surcharge mirror
grey tinted +84,03

cable extension (5 m)
for power supply unit

1.521,01
+31,93

surcharge mirror
grey tinted

1.884,03
+252,10
+378,15
+84,03

control

features

»color tune«, switch- and continuously dimmable via
»touchless control« (can be deactivated) and Occhio air (optional)

Mito set box

features adjustable via »touchless control«
(no external dimming). Alternative: color temperature
2700 K/3000 K/3500 K/4000 K adjustable in steps,
dimmable via trailing-edge phase cut dimmer
(not for »x-tra warm«)

Mito »air« box

Bluetooth control system integrated into the power
supply canopy, features via Occhio air app.

+82,35

options

light source

high color LED CRI95

2700 K–4000 K
with set or »air« box

Ⓢ **2200 K–3500 K »x-tra warm«**
only with »air« box
ø 40 +252,10
ø 60 +336,13

lighting effects

mirror

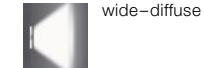

surfaces

head colors

matt white
matt black
matt silver
matt gold

materials/phantom/black phantom

rose gold
bronze
phantom
black phantom

cable (sfera corda)

matt white
matt black
matt chrome
matt gold

dark grey

The surfaces rose gold, bronze, phantom and black phantom may differ slightly from other product lines.

further options

- accessories for Occhio air from page 226

These and further options can be configured at
Occhio Digital Order System (DOS)

further information

- technical data, information on control and mounting options view pages 22–31

Mito sospeso mounting options

sospeso flat
for hollow ceiling mounting with flat cover, remote power supply

- ☉ synchronization of multiple luminaires via »air« sync possible (prerequisite all luminaires with »air« and same type)

☉ integrated set box (standard), »air« box optional or DALI box

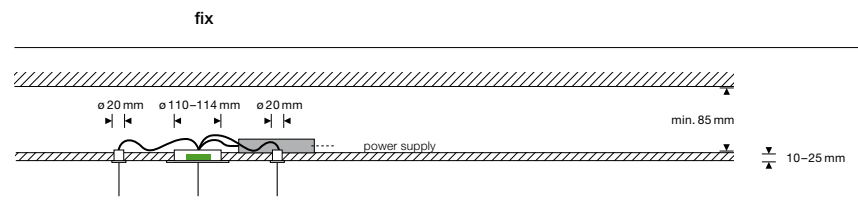

sospeso move up
for surface mounting with integrated power supply, through-wiring possible

- ☉ synchronization of multiple luminaires via »air« sync possible (prerequisite all luminaires with »air« and same type)

☉ »air« integrated

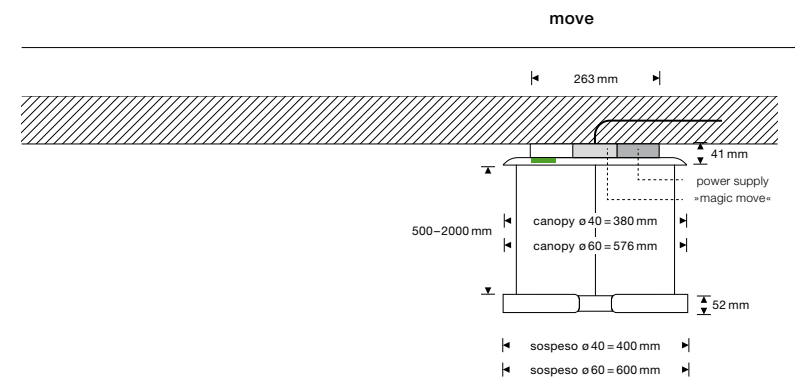

sospeso up
for surface mounting with integrated power supply, through-wiring possible

- ☉ synchronization of multiple luminaires via »air« sync possible (prerequisite all luminaires with »air« and same type)

☉ integrated set box (standard), »air« box optional or DALI box

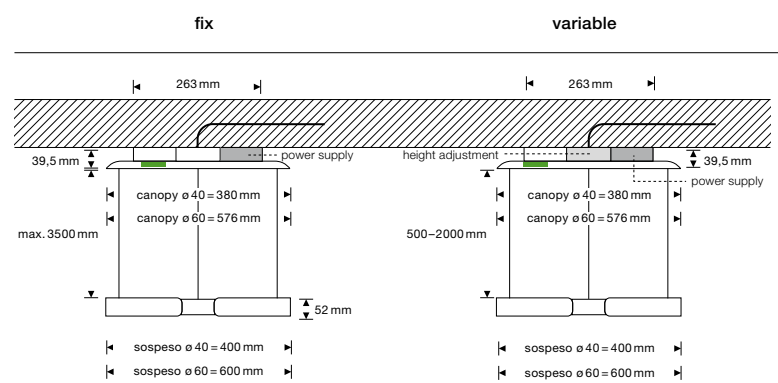

sospeso move pure
with plastering element for flush ceiling-mounted installation, integrated power supply, through-wiring possible

- ☉ synchronization of multiple luminaires via »air« sync possible (prerequisite all luminaires with »air« and same type)

☉ »air« integrated

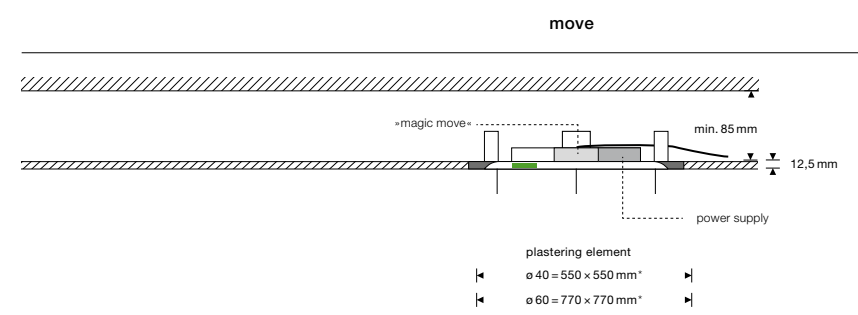

sospeso pure
with plastering element for flush ceiling-mounted installation, integrated power supply, through-wiring possible

- ☉ synchronization of multiple luminaires via »air« sync possible (prerequisite all luminaires with »air« and same type)

☉ integrated set box (standard), »air« box optional or DALI box

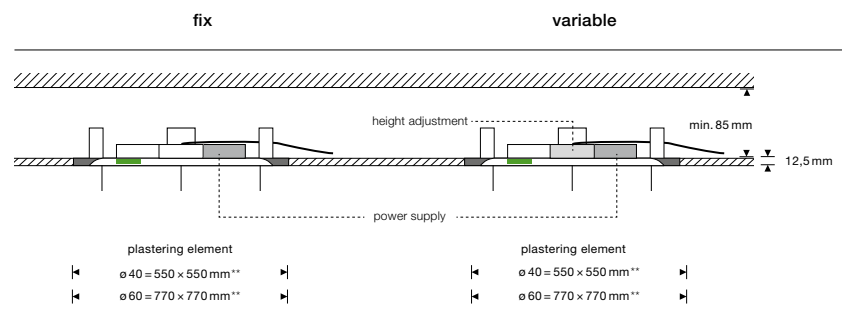

sospeso due
connecting element »Mito connexion« with integrated power supply for surface-mounting

connexion due ø 40:
L 663,5 mm x W 114,5 mm x H 19,5 mm

connexion due ø 60:
L 963,5 mm x W 114,5 mm x H 19,5 mm

- ☉ the luminaire heads are synched via an internal control line

☉ integrated set box (standard), »air« box optional or DALI box

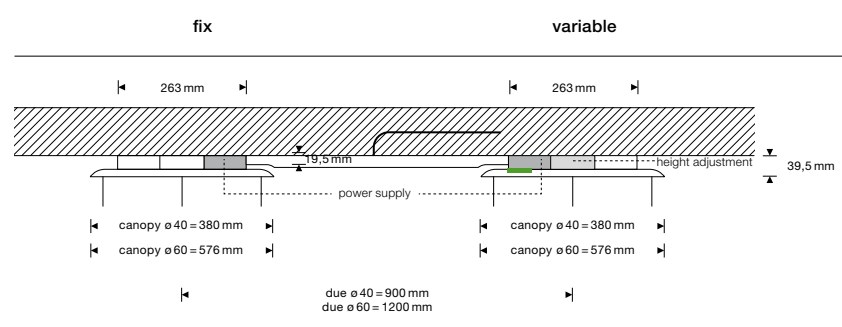

Mito cosmo mounting options

cosmo move
with plastering element for flush ceiling-mounted installation, external power supply (incl.)

Ⓢ synchronization of multiple luminaires via »air« sync possible (prerequisite all luminaires with »air« and same type)



»air« integrated

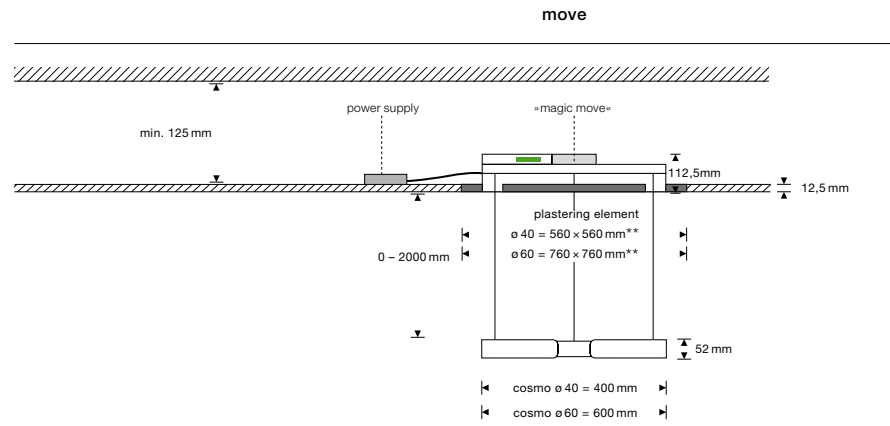

cosmo piano
with plastering element for flush ceiling-mounted installation, external power supply (incl.)

Ⓢ synchronization of multiple luminaires via »air« sync possible (prerequisite all luminaires with »air« and same type)



»air« integrated

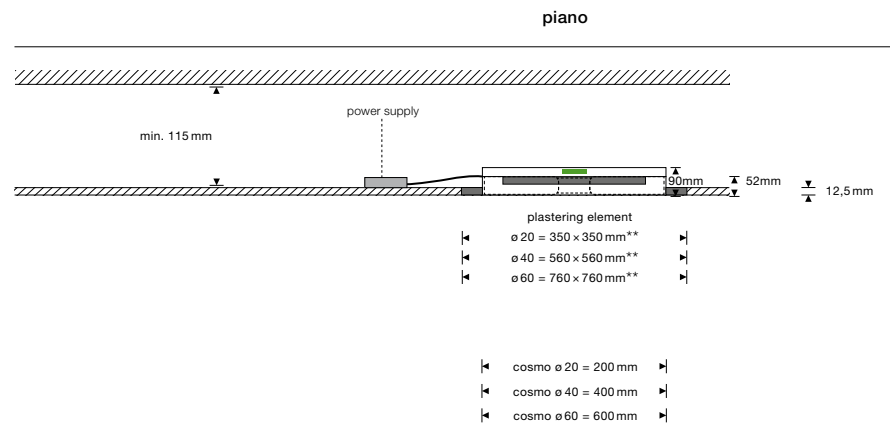

Mito aura mounting options

aura
for surface mounting with integrated power supply,
also suitable for wall mounting,
through-wiring possible

Ⓢ synchronization of multiple luminaires via
»air« sync possible (prerequisite all luminaires
with »air« and same type)

Ⓢ integrated set box (standard),
»air« box optional or DALI box

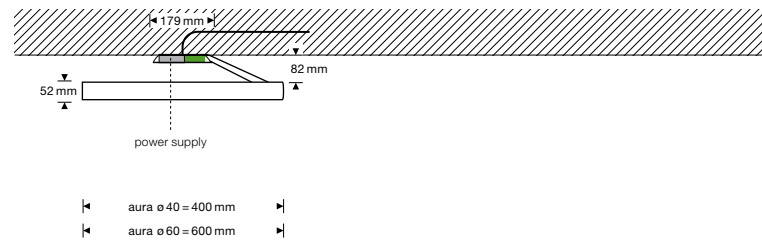

Mito soffitto mounting options

soffitto flat
for hollow ceiling mounting,
also suitable for wall mounting,
remote power supply (optional)

Ⓢ integrated set box (standard),
»air« box optional or DALI box

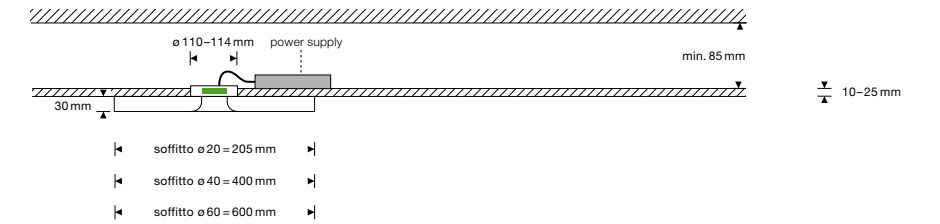

soffitto up
for surface mounting with integrated power supply,
also suitable for wall mounting,
through-wiring possible

Ⓢ integrated set box (standard),
»air« box optional or DALI box
(DALI only ø 40 and ø 60)

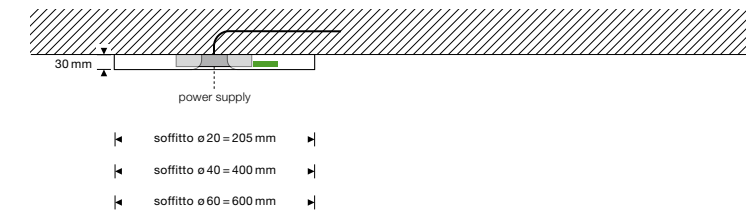

Mito sfera mounting options

sfera
for surface mounting with integrated power supply,
through-wiring possible

☉ synchronization of multiple luminaires via
»air« sync possible (prerequisite all luminaires
with »air« and same type)

 integrated set box (standard),
»air« box optional

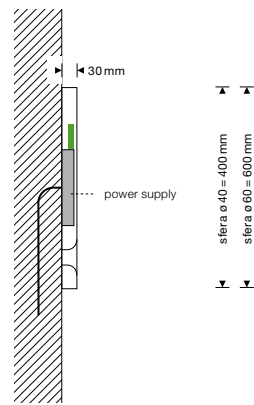

sfera su
for mounting on a mirror
incl. external power supply

☉ synchronization of multiple luminaires via
»air« sync possible (prerequisite all luminaires
with »air« and same type)

 integrated set box (standard),
»air« box optional

power supply behind mirror

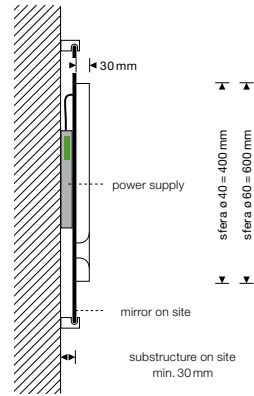

power supply in recess

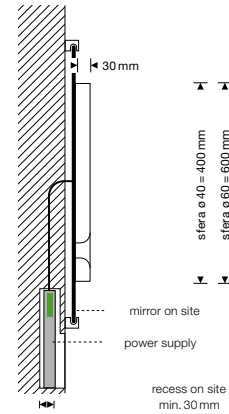

sfera corda
for surface mounting with integrated power supply,
incl. power cable for socket

☉ synchronization of multiple luminaires via
»air« sync possible (prerequisite all luminaires
with »air« and same type)

 integrated set box (standard),
»air« box optional

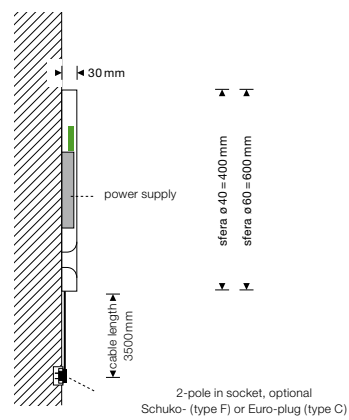

version »color tune«	connection	U	230 V AC	
		W	sospeso 40 -40 W sospeso 60 -60 W cosmo move 40 -40 W cosmo move 60 -60 W cosmo piano 20 -20 W cosmo piano 40 -40 W cosmo piano 60 -60 W soffitto 20 -20 W soffitto 40 -40 W soffitto 60 -60 W aura 40 -40 W aura 60 -60 W sfera 40 -20 W sfera 60 -40 W raggio -60 W largo -60 W	
average service life	t		> 50.000 h	
energy-efficiency class	EEK		G	
protection class			IP 20	IP 44 (Mito sfera and Mito sfera su)

LED color temperature	T	high color	2700–4000 K	x-tra warm	2200–3500 K
	CRI		Ra 95		Ra 95
recommended use			residential and public		residential

	power	luminous flux luminaire	high color		
			20 W	40 W	60 W
sospeso/cosmo move					
lighting effect table (wide)			2220 lm	3330 lm	
lighting effect room (narrow)			2140 lm	3210 lm	
cosmo piano					
lighting effect table (wide)			850 lm	1700 lm	2400 lm
lighting effect room (narrow)			720 lm	1440 lm	2060 lm
soffitto					
lighting effect wall (wide)			850 lm	1700 lm	2400 lm
lighting effect ceiling (narrow)			720 lm	1440 lm	2060 lm
aura					
lighting effect (wide)				2310 lm	3460 lm
lighting effect (narrow)				2140 lm	3210 lm
sfera/sfera su/sfera corda					
lighting effect wide-diffuse			800 lm	1600 lm	
raggio/largo					
lighting effect flood/wide					3330 lm

version (»color tune«)

Mito luminaires can be dimmed via »touchless control« (sospeso, sfera, raggio, largo), »body sensor« (raggio) and Occhio air (standard for raggio, largo, sospeso move, cosmo; optional for sospeso, soffitto, sfera). Alternatively dimming via trailing-edge phase cut* or DALI is possible (not raggio, largo, sospeso move, cosmo).

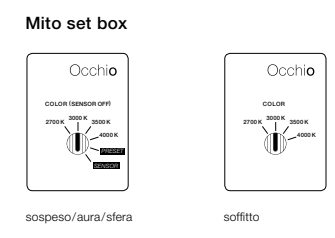

sospeso*/aura/sfera
COLOR (sensor off)
adjustable color temperature (4 steps),
trailing-edge phase cut dimming possible

PRESET (sospeso/aura)
adjustable color temperature (4 steps),
adjustable up/downlight ratio (5 steps)

PRESET (sfera)
adjustable color temperature (4 steps),
adjustable light intensity (5 steps)

SENSOR
»touchless control« (gesture control),
switching, dimming, »up/down fading«**,
»color tune« (color temperature continuously adjustable),
no external dimming possible

soffitto
COLOR
adjustable color temperature (4 steps),
trailing-edge phase cut dimming possible

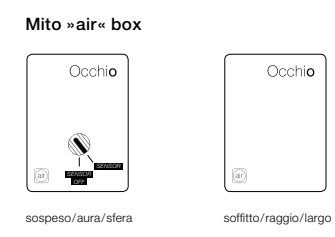

Occhio air
Bluetooth control via Occhio air app or »air« controller (optional),
control of individual luminaires, groups and scenes.

sospeso*/aura/sfera
SENSOR
»air« + »touchless control« (Bluetooth and gesture control), control via »touchless control« and Occhio air app or »air« controller, switching, dimming, »up/down fading«**, »color tune« (color temperature continuously adjustable)

SENSOR OFF
»air« (Bluetooth control), control via Occhio air app or »air« controller switching, dimming, »up/down fading«**, »color tune« (color temperature continuously adjustable)

raggio/largo
Bluetooth control integrated in power supply, »air« + »touchless control« (Bluetooth and gesture control) and »body sensor« (only raggio), control via »touchless control«, »body sensor« (nur raggio) and Occhio air app or »air« controller, switching, dimming, »up/down fading«, »color tune« (color temperature continuously adjustable), control and sensors can be deactivated via Occhio air App

soffitto
»air« (Bluetooth control), control via Occhio air app or »air« controller, switching, dimming, »color tune« (color temperature continuously adjustable)

sospeso move/cosmo
Bluetooth control integrated, »air« + »touchless control« (Bluetooth and gesture control), control via »touchless control« and Occhio air app or »air« controller, switching, dimming, »up/down fading«, »color tune« (color temperature continuously adjustable), »magic move« (electrical height adjustment), control and sensors can be deactivated via Occhio air app

No external dimming possible with Mito »air« box

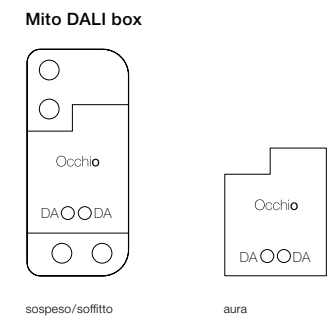

control via DALI

sospeso*/aura
adjustable color temperature***,
continuously dimmable,
uplight and downlight separately controllable (two DALI addresses required),
no »touchless control«, no »up/down fading«

soffitto (DALI not for Mito soffitto 20 up)
adjustable color temperature***,
continuously dimmable

*not Mito sospeso move
**not Mito sfera
***A DALI controller »DALI device type 8 (DT8)« is required to control the light color.
Further information can be found at occhio.com/dali

X series

Edizione Lusso

Precious marble, finest ascot leather, fascinating new surface finishes: Edizione Lusso focuses on extraordinary materials. The exclusive edition includes luminaires from the Mito series and gives them a new and incomparable appearance with exquisite accents.

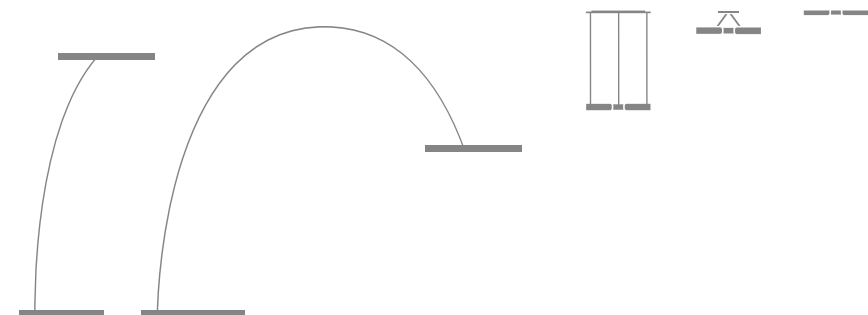

Mito raggio lusso



scuro

7.176,47



caldo

7.176,47



vivo

7.176,47

height 205 cm
ø head 60 cm, 60 W (3330 lm)

surfaces

- head**
black phantom
- body (Ascot leather)**
nero
- base (marble)**
nero marquina

- head**
phantom
- body (Ascot leather)**
marrone
- base (marble)**
marrone emperador

- head**
phantom
- body (Ascot leather)**
grigio
- base (marble)**
verde guatemala

control



features
»color tune«, »up/down fading«, switch- and dimmable
via »touchless control«, »body sensor« (only raggio),
and Occhio air (included)

Occhio air 
Bluetooth control integrated in power supply.
Features via Occhio air app or »air« controller
(optional) controllable, no external dimming

options

light source
high color LED CRI95
2700 K-4000 K **2200 K-3500 K »x-tra warm«**
+ 504,20

lighting effects

 flood
 wide

further options

These and further options can be configured at
Occhio Digital Order System (DOS)

further information

- technical data, information on control
and on mounting options view pages 22-31

Mito largo lusso



scuro

9.243,70



caldo

9.243,70



vivo

9.243,70

height head 130 cm, 145 cm, 160 cm (adjustable)
resulting total height approx. 210–240 cm, ø head 60 cm, 60W (3330 lm)

surfaces

head

black phantom 

body (Ascot leather)

nero 

base (marble)

nero marquina 

head

phantom 

body (Ascot leather)

marrone 

base (marble)

marrone emperador 

head

phantom 

body (Ascot leather)

grigio 

base (marble)

verde guatemala 

control

features

»color tune«, »up/down fading«, switch- and dimmable
via »touchless control«, »body sensor« (only raggio),
and Occhio air (included)

Occhio air 

Bluetooth control integrated in power supply.
Features via Occhio air app or »air« controller
(optional) controllable, no external dimming

options

light source

high color LED CRI95

2700 K–4000 K

2200 K–3500 K »x-tra warm«
+ 504,20

lighting effects

 flood

 wide

further options

These and further options can be configured at
Occhio Digital Order System (DOS)

further information

- technical data, information on control
and on mounting options view pages 22–31

Mito sospeso 40 lusso



scuro

caldo

vivo

intenso

oro

puro

3.260,50

3.260,50

3.260,50

3.134,45

2.882,35

2.882,35

⊙ special lengths up to 500 cm possible (surcharge per head +319,33, discountable)

continuous height adjustment 50–200 cm, for surface-mounted installation
ø 40 cm, 40 W (2220 lm) through-wiring possible

surfaces	head	cover (Ascot leather)	head	cover (Ascot leather)	head	cover (Ascot leather)	head	cover (Ascot leather)	head	cover (Ascot leather)		
	black phantom	nero	phantom	marrone	phantom	grigio	rose gold	grigio	matt gold	bianco	matt white	bianco
control	features »color tune«, »up/down fading«, switch- and continuously dimmable via »touchless control« (can be deactivated) and Occhio air (optional)		Mito set box features adjustable via »touchless control« (no external dimming). Alternative: color temperature 2700 K/3000 K/3500 K/4000 K and »up/down fading« adjustable, dimmable via trailing-edge phase cut dimmer (not for »x-tra warm«)			Mito »air« box Bluetooth control integrated in cover/canopy. Features via Occhio air app or »air« controller (optional) controllable (no external dimming) +82,35		Mito DALI box version for building control system via DALI (no »touchless control«) +82,35				
options	light source high color LED CRI 95 2700 K–4000 K with set, »air« or DALI box ⊙ 2200 K–3500 K »x-tra warm« only with »air« or DALI box +336,13					lighting effects room: diffuse narrow, table: flood wide						
further options	These and further options can be configured at Occhio Digital Order System (DOS)					further information - technical data, information on control and on mounting options view pages 22–31						

Mito sospeso 60 lusso



scuro

caldo

vivo

intenso

oro

puro

4.369,75

4.369,75

4.369,75

4.176,47

3.789,92

3.789,92

⦿ special lengths up to 500 cm possible (surcharge per head +319,33, discountable)

continuous height adjustment 50–200 cm, for surface-mounted installation
 ø60 cm, 60 W (3330 lm) through-wiring possible

surfaces	head	cover (Ascot leather)	head	cover (Ascot leather)	head	cover (Ascot leather)	head	cover (Ascot leather)	head	cover (Ascot leather)		
	black phantom	nero	phantom	marrone	phantom	grigio	rose gold	grigio	matt gold	bianco	matt white	bianco

control	features	Mito set box	Mito »air« box	Mito DALI box
	»color tune«, »up/down fading«, switch- and continuously dimmable via »touchless control« (can be deactivated) and Occhio air (optional)	features adjustable via »touchless control« (no external dimming). Alternative: color temperature 2700 K/3000 K/3500 K/4000 K and »up/down fading« adjustable, dimmable via trailing-edge phase cut dimmer (not for »x-tra warm«)	Bluetooth control integrated in cover/canopy. Features via Occhio air app or »air« controller (optional) controllable (no external dimming) +82,35	version for building control system via DALI (no »touchless control«) +82,35

options	light source	lighting effects
	high color LED CRI 95 2700 K–4000 K with set, »air« or DALI box ⦿ 2200 K–3500 K »x-tra warm« only with »air« or DALI box +504,20	room diffuse narrow table flood wide

further options These and further options can be configured at **Occhio Digital Order System (DOS)**

further information - technical data, information on control and on mounting options view pages 22–31

Mito aura 40 lusso



scuro

caldo

vivo

intenso

oro

puro

2.436,97

2.436,97

2.436,97

2.310,92

2.058,82

2.058,82

for surface-mounted installation, incl. power supply
ø 40 cm, 40 W (2310 lm), H 13,5 cm

surfaces	scuro	caldo	vivo	intenso	oro	puro
head	black phantom	phantom	phantom	rose gold	matt gold	matt white
body	matt black	matt black	matt black	matt black	matt white	matt white
cover (Ascot leather)	nero	marrone	grigio	grigio	bianco	bianco

control	scuro	caldo	vivo	intenso	oro	puro
features	»color tune«, »up/down fading«, switch- and continuously dimmable via »touchless control« (can be deactivated) and Occhio air (optional)			Mito »air« box		
				Bluetooth control integrated in cover/canopy. Features via Occhio air app or »air« controller (optional) controllable (no external dimming) +82,35		
				Mito DALI box version for building control system via DALI (no »touchless control«) +82,35		

options	scuro	caldo	vivo	intenso	oro	puro
light source	high color LED CRI 95 2700 K–4000 K with set, »air« or DALI box			◎ 2200 K–3500 K »x-tra warm« only with »air« or DALI box +336,13		
lighting effects				ceiling narrow	ceiling wide	wall wide

further options These and further options can be configured at **Occhio Digital Order System (DOS)**

further information - technical data, information on control and on mounting options view pages 22–31

Mito aura 60 lusso

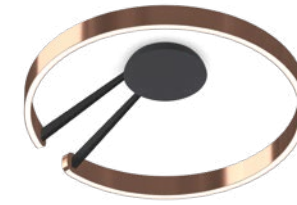
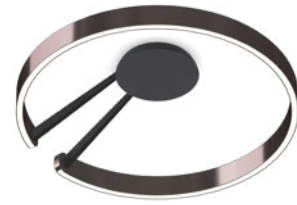
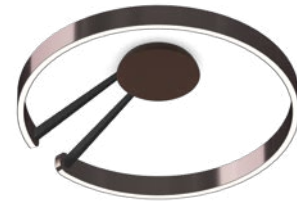
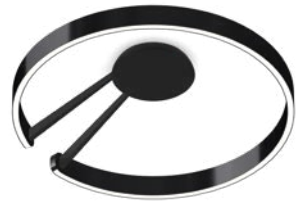

scuro

caldo

vivo

intenso

oro

puro

3.294,12

3.294,12

3.294,12

3.100,84

2.714,29

2.714,29

for surface-mounted installation, incl. power supply
ø 40 cm, 40 W (3460 lm), H 13,5 cm

surfaces	scuro	caldo	vivo	intenso	oro	puro
head	black phantom	phantom	phantom	rose gold	matt gold	matt white
body	matt black	matt black	matt black	matt black	matt white	matt white
cover (Ascot leather)	nero	marrone	grigio	grigio	bianco	bianco

control	scuro	caldo	vivo	intenso	oro	puro
features	»color tune«, »up/down fading«, switch- and continuously dimmable via »touchless control« (can be deactivated) and Occhio air (optional)		Mito set box	Mito »air« box	Mito DALI box	
			features adjustable via »touchless control« (no external dimming). Alternative: color temperature 2700 K/3000 K/3500 K/4000 K and »up/down fading« adjustable, dimmable via trailing-edge phase cut dimmer (not for »x-tra warm«)	Bluetooth control integrated in cover/canopy. Features via Occhio air app or »air« controller (optional) controllable (no external dimming)	version for building control system via DALI (no »touchless control«)	
				+82,35	+82,35	

options	scuro	caldo	vivo	intenso	oro	puro
light source	high color LED CRI 95			lighting effects		
	2700 K–4000 K with set, »air« or DALI box			ceiling diffuse narrow	ceiling diffuse wide	wall diffuse wide
	© 2200 K–3500 K »x-tra warm« only with »air« or DALI box +504,20					

further options These and further options can be configured at **Occhio Digital Order System (DOS)**

further information - technical data, information on control and on mounting options view pages 22–31

Mito soffitto 20 lusso



scuro

caldo

vivo

intenso

oro

puro

1.159,66

1.159,66

1.159,66

1.109,24

1.008,40

1.008,40

for surface-mounted installation, ø20 cm, 20W (850lm)
through-wiring possible

surfaces	head black phantom 	head phantom 	head phantom 	head rose gold 	head matt gold 	head matt white 
	cover (Ascot leather) nero 	cover (Ascot leather) marrone 	cover (Ascot leather) grigio 	cover (Ascot leather) grigio 	cover (Ascot leather) bianco 	cover (Ascot leather) bianco 
control	features »color tune«, switch- and continuously dimmable via Occhio air (optional)		Mito set box color temperature 2700 K/3000 K/3500 K/4000 K adjustable, dimmable via trailing-edge phase cut dimmer (not for »x-tra warm«)	Mito »air« box  Bluetooth control integrated in cover/canopy. Features via Occhio air app or »air« controller (optional) controllable (no external dimming) +82,35	Mito DALI box version for building control system via DALI +82,35	
options	light source high color LED CRI95 2700 K–4000 K with set, »air« or DALI box			lighting effects ceiling narrow  ceiling wide  wall to wall wide 		
further options	These and further options can be configured at Occhio Digital Order System (DOS)			further information	- technical data, information on control and on mounting options view pages 22–31	

Mito soffitto 40 lusso



scuro

caldo

vivo

intenso

oro

puro

1.731,09

1.731,09

1.731,09

1.655,46

1.504,20

1.504,20

for surface-mounted installation, ø 40 cm, 40 W (1700 lm)
through-wiring possible

surfaces	head black phantom 	head phantom 	head phantom 	head rose gold 	head matt gold 	head matt white 
	cover (Ascot leather) nero 	cover (Ascot leather) marrone 	cover (Ascot leather) grigio 	cover (Ascot leather) grigio 	cover (Ascot leather) bianco 	cover (Ascot leather) bianco 
control	features »color tune«, switch- and continuously dimmable via Occhio air (optional)		Mito set box color temperature 2700 K/3000 K/3500 K/4000 K adjustable, dimmable via trailing-edge phase cut dimmer (not for »x-tra warm«)	Mito »air« box  Bluetooth control integrated in cover/canopy. Features via Occhio air app or »air« controller (optional) controllable (no external dimming) +82,35		Mito DALI box version for building control system via DALI +82,35
	options	light source high color LED CRI 95 2700 K–4000 K with set, »air« or DALI box © 2200 K–3500 K »x-tra warm« only with »air« or DALI box +252,10		lighting effects ceiling narrow  ceiling wide  wall to wall wide 		
further options		These and further options can be configured at Occhio Digital Order System (DOS)			further information	- technical data, information on control and on mounting options view pages 22–31

Mito soffitto 60 lusso



scuro

caldo

vivo

intenso

oro

puro

2.504,20

2.504,20

2.504,20

2.386,55

2.151,26

2.151,26

for surface-mounted installation, ø 60 cm, 60 W (2400 lm)
through-wiring possible

surfaces	head black phantom 	head phantom 	head phantom 	head rose gold 	head matt gold 	head matt white 
	cover (Ascot leather) nero 	cover (Ascot leather) marrone 	cover (Ascot leather) grigio 	cover (Ascot leather) grigio 	cover (Ascot leather) bianco 	cover (Ascot leather) bianco 
control	features »color tune«, switch- and continuously dimmable via Occhio air (optional)		Mito set box color temperature 2700 K/3000 K/3500 K/4000 K adjustable, dimmable via trailing-edge phase cut dimmer (not for »x-tra warm«)	Mito »air« box  Bluetooth control integrated in cover/canopy. Features via Occhio air app or »air« controller (optional) controllable (no external dimming) +82,35	Mito DALI box version for building control system via DALI +82,35	
	options	light source high color LED CRI 95 2700 K–4000 K with set, »air« or DALI box © 2200 K–3500 K »x-tra warm« only with »air« or DALI box +336,13		lighting effects ceiling narrow  ceiling wide  wall to wall wide 		
further options		These and further options can be configured at Occhio Digital Order System (DOS)			further information	- technical data, information on control and on mounting options view pages 22–31

X series

Mito linear

The new shape of light. Mito linear is the logical extension of the iconic Mito series. It transfers the design claim and the extraordinary lighting quality of Mito in brand new application areas in the residential and contract sector. With its comprehensive concept and innovative features Mito linear enables a new dimension of holistic lighting design.

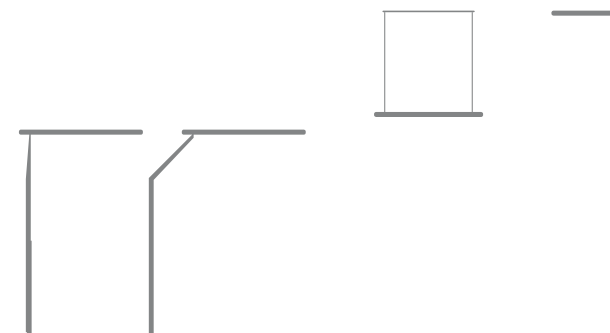

Mito linear
floor- and table luminaires



terra 190

head length 115 cm
height 190 cm

head fix

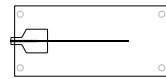

☺ can be synced via Occhio air

terra 220

head length 115 cm
height 220 cm

head fix

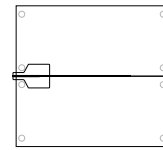

☺ can be synced via Occhio air

terra var

head length 115 cm
height adjustable 190-220 cm

head fix

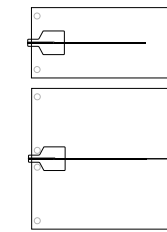

☺ can be synced via Occhio air

table top

head length 115 cm
height 145 cm, 220 cm at 75 cm
standard table height

head fix

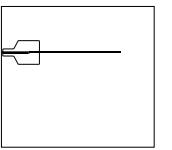

☺ can be synced via Occhio air

70W (4600 lm)	colors	2.504,20	2.603,36	2.878,99	2.411,76
56W (3600 lm)	materials	+235,29		+235,29	
56W (3600 lm)	phantom/ black phantom	+352,94		+352,94	

control	features	Occhio air
	switch- and dimmable via »touchless control« and »body sensor«, presence recognition via »presence sensor«, adaptation to ambient light via »ambient light control«, additionally controllable via Occhio air (inclusive)	Bluetooth control integrated in power supply, features via Occhio air app or »air« controller (optional) controllable, no external dimming

options	light source	lighting effects	surfaces	head/body/base colors	materials/phantom/black phantom
	high color LED CRI95 2700 K-4000 K	flood wide asymmetric light emission			

The surfaces rose gold, bronze, phantom and black phantom may differ slightly from other product lines.

further options	- accessories for Occhio air from page 226	These and further options can be configured at Occhio Digital Order System (DOS)	further information	- technical data and information on control view pages 80-81
------------------------	--	---	----------------------------	--

Mito linear
floor luminaires



terra 3d

head length 115 cm
height 190 cm
head swivelable by 60°

☺ can be synced via Occhio air

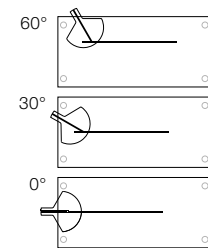



70 W (4600 lm)	colors	2.924,37
56 W (3600 lm)	materials	+235,29
56 W (3600 lm)	phantom/ black phantom	+352,94

control	features
	switch- and dimmable via »touchless control« and »body sensor«, presence recognition via »presence sensor«, adaptation to ambient light via »ambient light control«, additionally controllable via Occhio air (inclusive)



Occhio air 
Bluetooth control integrated in power supply, features via Occhio air app or »air« controller (optional) controllable, no external dimming



options	light source
	high color LED CRI95 2700 K-4000 K

lighting effects
 flood  wide  symmetric light emission





surfaces

head/body/base colors

matt white	
matt black	
matt silver	

matt black/matt silver	
gold matt/matt white	
gold matt/matt black	

materials/phantom/black phantom

rose gold/matt black	
bronze/matt black	
phantom/matt black	
black phantom/matt black	

The surfaces rose gold, bronze, phantom and black phantom may differ slightly from other product lines.

further options - accessories for Occhio air from page 226

These and further options can be configured at **Occhio Digital Order System (DOS)**

further information - technical data and information on control view pages 80-81

Mito linear
suspended luminaires
volo 100



fix flat

fix up

fix up midfeed

fix
pendant length adjustable
during mounting, max. 350 cm

fix
for hollow ceiling
length 103 cm, 45 W (2900 lm)
incl. remote converter

fix
for surface-mounted installation
length 103 cm, 45 W (2900 lm)
through-wiring possible
incl. converter

fix
for surface-mounted installation/midfeed
length 103 cm, 45 W (2900 lm)
through-wiring possible
incl. converter

Ⓢ can be synced via Occhio air

Ⓢ can be synced via Occhio air

Ⓢ can be synced via Occhio air

colors 1.453,78
materials +201,68
phantom/black phantom +302,52

1.598,32

1.678,99
+201,68
+302,52

control

features
»color tune«, »up/down fading«, switch- and continuously dimmable
via »touchless control« (can be deactivated) and Occhio air (optional)

Mito set box
features adjustable via »touchless control«
(no external dimming). Alternative: color temperature
2700 K/3000 K/3500 K/4000 K and »up/down fading«
adjustable, dimmable via trailing-edge phase
cut dimmer (not for »x-tra warm«)

Mito »air« box 
Bluetooth control integrated in luminaire. Features via
Occhio air app or »air« controller (optional) controllable
(no external dimming)

+ 82,35

Mito DALI box
external control via DALI
(no »touchless control«)

+ 82,35





options

light source
high color LED CRI 95

2700 K–4000 K
with set, »air« or
DALI box

Ⓢ **2200 K–3500 K »x-tra warm«**
only with »air« or DALI box
+ 294,12





lighting effects

room  diffuse  flood
 narrow  wide





table

surfaces

head colors

matt white 
matt black 
matt silver 
matt gold 

materials/phantom/black phantom

rose gold 
bronze 
phantom 
black phantom 

canopy

matt white 
matt black* 

*canopy in matt black (surcharge + 134,45; flat Version + 67,23) Ⓢ
The surfaces rose gold, bronze, phantom and black phantom may differ slightly from other product lines.

further options - accessories for Occhio air from page 226

These and further options can be configured at
Occhio Digital Order System (DOS)

further information - technical data, information on control
and on mounting options view pages 74–81

Mito linear
suspended luminaires
volo 100

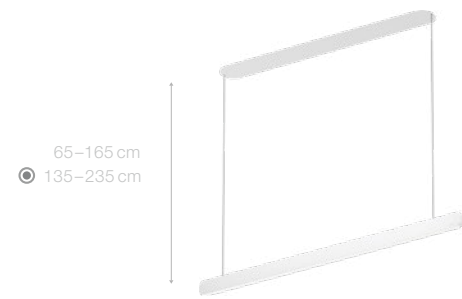
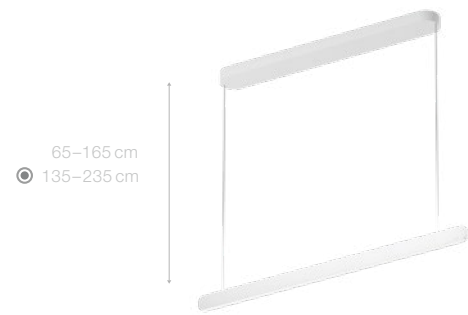

var up

var pure

fix track

<p>variable continuous height adjustment 65–165 cm 135–235 cm</p> <p>fix pendant length adjustable during mounting, max. 350 cm</p>	<p>variable for surface-mounted installation length 103 cm, 45 W (2900 lm) through-wiring possible incl. converter</p> <p>Ⓢ can be synced via Occhio air</p>	<p>variable flush ceiling-mounted installation in hollow ceiling, incl. mounting board, power supply integrated in luminaire length 103 cm, 45 W (2900 lm) incl. converter</p> <p>Ⓢ can be synced via Occhio air</p>	<p>fix with in-trac adapter, for Eutrac, Erco and Zumtobel 3-phase tracks length 103 cm, 45 W (2900 lm) incl. remote converter</p> <p>Ⓢ can be synced via Occhio air</p>		
<p>colors</p> <p>materials</p> <p>phantom/black phantom</p>	<p>65–165 cm 135–235 cm</p> <p>2.084,81 2.218,49</p> <p>+201,68</p> <p>+302,52</p> <p>Ⓢ special lengths up to 500 cm possible (surcharge per head +319,33, discountable)</p>	<p>65–165 cm 135–235 cm</p> <p>2.499,16 2.633,61</p>	<p>1.700,84</p> <p>+201,68</p> <p>+302,52</p>		
<p>control</p>	<p>features</p> <p>»color tune«, »up/down fading«, switch- and continuously dimmable via »touchless control« (can be deactivated) and Occhio air (optional)</p>	<p>Mito set box</p> <p>features adjustable via »touchless control« (no external dimming). Alternative: color temperature 2700 K/3000 K/3500 K/4000 K and »up/down fading« adjustable, dimmable via trailing-edge phase cut dimmer (not for »x-tra warm«)</p>	<p>Mito »air« box </p> <p>Bluetooth control integrated in luminaire. Features via Occhio air app or »air« controller (optional) controllable (no external dimming)</p> <p>+ 82,35</p>	<p>Mito DALI box</p> <p>external control via DALI (no »touchless control«) version track: only for OneTrack by Eutrac/Stucchi track</p> <p>+ 82,35</p>	
<p>options</p>	<p>light source</p> <p>high color LED CRI95</p> <p>2700 K–4000 K with set, »air« or DALI box</p> <p>Ⓢ 2200 K–3500 K »x-tra warm« only with »air« or DALI box + 294,12</p>	<p>lighting effects</p> <p>room table</p> <p> diffuse flood narrow wide</p>	<p>surfaces</p>	<p>head colors</p> <p>matt white matt black matt silver matt gold </p> <p>materials/phantom/black phantom</p> <p>rose gold bronze phantom black phantom </p> <p>*canopy in matt black (surcharge + 134,45) Ⓢ The surfaces rose gold, bronze, phantom and black phantom may differ slightly from other product lines.</p>	<p>canopy</p> <p>matt white matt black* </p>
<p>further options</p>	<p>- accessories for Occhio air from page 226</p>	<p>These and further options can be configured at Occhio Digital Order System (DOS)</p>	<p>further information</p>	<p>- technical data, information on control and on mounting options view pages 74–81</p>	

Mito linear
suspended luminaires
volo 140

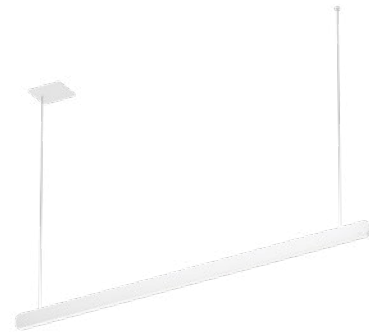

fix flat



fix up



fix up midfeed

fix
pendant length adjustable
during mounting, max. 350 cm

fix
for hollow ceiling
length 136 cm, 60 W (3900 lm)
incl. remote converter

Ⓢ can be synced via Occhio air

colors
materials
phantom/black phantom

1.784,87
+268,91
+403,36

fix
for surface-mounted installation
length 136 cm, 60 W (3900 lm)
through-wiring possible
incl. converter

Ⓢ can be synced via Occhio air

1.929,41

fix
for surface-mounted installation/midfeed
length 136 cm, 60 W (3900 lm)
through-wiring possible
incl. converter

Ⓢ can be synced via Occhio air

2.052,10
+268,91
+403,36

control

features
»color tune«, »up/down fading«, switch- and continuously dimmable
via »touchless control« (can be deactivated) and Occhio air (optional)

Mito set box
features adjustable via »touchless control«
(no external dimming). Alternative: color temperature
2700 K/3000 K/3500 K/4000 K and »up/down fading«
adjustable, dimmable via trailing-edge phase
cut dimmer (not for »x-tra warm«)

Mito »air« box 
Bluetooth control integrated in luminaire. Features via
Occhio air app or »air« controller (optional) controllable
(no external dimming)



+ 82,35

Mito DALI box
external control via DALI
(no »touchless control«)









+ 82,35

options

light source
high color LED CRI 95
2700 K–4000 K
with set, »air« or
DALI box
Ⓢ **2200 K–3500 K »x-tra warm«**
only with »air« or DALI box
+ 420,17

lighting effects
room  diffuse narrow  flood wide
table

surfaces

head colors
matt white 
matt black 
matt silver 
matt gold 
materials/phantom/black phantom
rose gold 
bronze 
phantom 
black phantom 

canopy
matt white 
matt black* 

*canopy in matt black (surcharge + 201,68; flat Version + 67,23) Ⓢ
The surfaces rose gold, bronze, phantom and black phantom may differ slightly from other product lines.

further options

- accessories for Occhio air from page 226

These and further options can be configured at
Occhio Digital Order System (DOS)

further information

- technical data, information on control
and on mounting options view pages 74–81

Mito linear



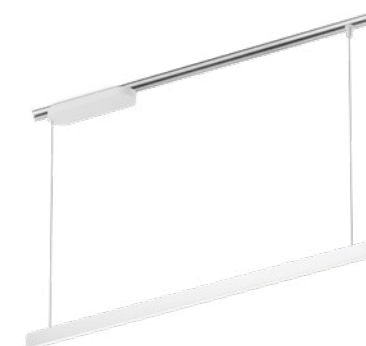











suspended luminaires
volo 140



var up

var pure

fix track

<p>variable continuous height adjustment 65–165 cm <input checked="" type="radio"/> 135–235 cm</p> <p>fix pendant length adjustable during mounting, max. 350 cm</p>	<p>variable for surface-mounted installation length 136 cm, 60 W (3900 lm) through-wiring possible incl. converter</p> <p><input checked="" type="radio"/> can be synced via Occhio air</p>	<p>variable flush ceiling-mounted installation in hollow ceiling, incl. mounting board, power supply integrated in luminaire length 136 cm, 60 W (3900 lm) incl. converter</p> <p><input checked="" type="radio"/> can be synced via Occhio air</p>	<p>fix with in-trac adapter, for Eutrac, Erco and Zumtobel 3-phase tracks length 136 cm, 60 W (3900 lm) incl. remote converter</p> <p><input checked="" type="radio"/> can be synced via Occhio air</p>		
<p>colors</p> <p>materials</p> <p>phantom/black phantom</p>	<p>65–165 cm <input checked="" type="radio"/> 135–235 cm</p> <p>2.504,20 2.705,88</p> <p>+268,91</p> <p>+403,36</p> <p><input checked="" type="radio"/> special lengths up to 500 cm possible (surcharge per head +319,33, discountable)</p>	<p>65–165 cm <input checked="" type="radio"/> 135–235 cm</p> <p>3.021,85 3.223,67</p>	<p>2.031,93</p> <p>+268,91</p> <p>+403,36</p>		
<p>control</p>	<p>features »color tune«, »up/down fading«, switch- and continuously dimmable via »touchless control« (can be deactivated) and Occhio air (optional)</p>	<p>Mito set box features adjustable via »touchless control« (no external dimming). Alternative: color temperature 2700 K/3000 K/3500 K/4000 K and »up/down fading« adjustable, dimmable via trailing-edge phase cut dimmer (not for »x-tra warm«)</p>	<p>Mito »air« box  Bluetooth control integrated in luminaire. Features via Occhio air app or »air« controller (optional) controllable (no external dimming)</p> <p>+ 82,35</p>	<p>Mito DALI box external control via DALI (no »touchless control«) version track: only for OneTrack by Eutrac/Stucchi track</p> <p>+ 82,35</p>	
<p>options</p>	<p>light source high color LED CRI95</p> <p>2700 K–4000 K with set, »air« or DALI box</p> <p><input checked="" type="radio"/> 2200 K–3500 K »x-tra warm« only with »air« or DALI box + 420,17</p>	<p>lighting effects</p> <p>room table</p> <p> diffuse  flood  narrow  wide</p>	<p>surfaces</p>	<p>head colors</p> <p>matt white  matt black  matt silver  matt gold </p> <p>materials/phantom/black phantom</p> <p>rose gold  bronze  phantom  black phantom </p> <p>*canopy in matt black (surcharge + 201,68) <input checked="" type="radio"/> The surfaces rose gold, bronze, phantom and black phantom may differ slightly from other product lines.</p>	<p>canopy</p> <p>matt white  matt black* </p>
<p>further options</p>	<p>- accessories for Occhio air from page 226</p>	<p>These and further options can be configured at Occhio Digital Order System (DOS)</p>	<p>further information</p>	<p>- technical data, information on control and on mounting options view pages 74–81</p>	

Mito linear

ceiling luminaires
alto 40



flat

for hollow ceiling
height 32 mm, length 37 cm, 15 W (800 lm)
incl. remote converter



up

for surface-mounted installation
height 52 mm, length 37 cm, 15 W (800 lm)
incl. converter



pure

recessed installation in hollow ceiling, incl. mounting board,
power supply integrated in luminaire
height 20 mm, length 37 cm, 15 W (800 lm)
incl. converter



track

with in-trac adapter, for Eutrac, Erco and Zumtobel 3-phase tracks
height 52 mm, length 37 cm, 15 W (800 lm)
incl. converter

colors	571,43
materials	+67,23
phantom/black phantom	+100,84

colors	621,85
materials	+100,84
phantom/black phantom	+151,26

colors	806,72
materials	+100,84
phantom/black phantom	+151,26

colors	705,88
--------	--------

alto 70



flat

for hollow ceiling
height 32 mm, length 70 cm, 30 W (1600 lm)



up

for surface-mounted installation
height 52 mm, length 70 cm, 30 W (1600 lm)
incl. converter



pure

recessed installation in hollow ceiling, incl. mounting board,
power supply integrated in luminaire
height 20 mm, length 70 cm, 30 W (1600 lm)
incl. converter



track

with in-trac adapter, for Eutrac, Erco and Zumtobel 3-phase tracks
height 52 mm, length 70 cm, 30 W (1600 lm)
incl. converter

colors	789,92
materials	+100,84
phantom/black phantom	+151,26

colors	857,14
materials	+134,45
phantom/black phantom	+201,68

colors	1.075,63
materials	+134,45
phantom/black phantom	+201,68

colors	941,18
--------	--------

mounting options (included)



inlay
(flat/up)



»air« inlay
(up)



cover for ceiling box
(flat/up)

control	features
	»color tune«, switch- and continuously dimmable via Occhio air (optional)

Mito set box
color temperature 2700 K/3000 K/3500 K/4000 K adjustable in steps, dimmable via trailing-edge phase cut dimmer (not for »x-tra warm«)

Mito »air« box
Bluetooth control integrated in luminaire, features via Occhio air app or »air« controller (optional) controllable (no external dimming)
+82,35

Mito DALI box
version for building control system via DALI version track: only for OneTrack by Eutrac/Stucchi track
+82,35

options	light source
	high color LED CRI95 2700 K–4000 K with set, »air« or DALI box

<input checked="" type="radio"/> 2200 K–3500 K »x-tra warm« only with »air« or DALI box L 40 cm + 126,05 L 70 cm + 189,08

lighting effects
narrow
wide

surfaces

head/inlay colors

matt white	
matt white/matt black	
matt black	
matt black/matt white	

matt silver	
matt gold/matt white	
matt gold/matt black	

materials/phantom/black phantom

rose gold/matt white	
rose gold/matt black	
bronze/matt white	
bronze/matt black	

phantom/matt white	
phantom/matt black	
black phantom/ matt white	
black phantom/ matt black	

The surfaces rose gold, bronze, phantom and black phantom may differ slightly from other product lines.

further options	- accessories for Occhio air from page 226
------------------------	--

These and further options can be configured at
Occhio Digital Order System (DOS)

further information	- technical data, information on control and on mounting options view pages 74–81
----------------------------	--

Mito linear
ceiling luminaires
alto 100



flat

for hollow ceiling
height 32 mm, length 103 cm, 45 W (2400 lm)
incl. remote converter

up

for surface-mounted installation
height 52 mm, length 103 cm, 45 W (2400 lm)
incl. converter

pure

recessed installation in hollow ceiling, incl. mounting board,
power supply integrated in luminaire
height 20 mm, length 103 cm, 45 W (2400 lm)
incl. converter

track

with in-trac adapter, for Eutrac, Erco and Zumtobel 3-phase tracks
height 52 mm, length 103 cm, 45 W (2400 lm)
incl. converter

colors	991,60
materials	+151,26
phantom/black phantom	+226,89

colors	1.075,63
materials	+184,87
phantom/black phantom	+277,31

colors	1.327,73
materials	+184,87
phantom/black phantom	+277,31

colors	1.159,66
materials	
phantom/black phantom	

mounting options
(included)



inlay
(flat/up)



»air« inlay
(up)



cover for ceiling box
(flat/up)

control

features

»color tune«, switch- and continuously dimmable
via Occhio air (optional)

Mito set box

color temperature 2700 K/3000 K/3500 K/4000 K
adjustable in steps, dimmable via trailing-edge phase
cut dimmer (not for »x-tra warm«)

Mito »air« box



Bluetooth control integrated in luminaire,
features via Occhio air app or »air« controller (optional)
controllable (no external dimming)

Mito DALI box

version for building control system via DALI
version track: only for OneTrack by Eutrac/Stucchi track

+82,35

+82,35

options

light source

high color LED CRI95

2700 K–4000 K
with set, »air« or
DALI box

2200 K–3500 K »x-tra warm«
only with »air« or DALI box
+252,10

lighting effects

narrow



wide



surfaces

head/inlay
colors

matt white
matt white/matt black
matt black
matt black/matt white



matt silver
matt gold/matt white
matt gold/matt black



materials/phantom/black phantom

rose gold/matt white
rose gold/matt black
bronze/matt white
bronze/matt black



phantom/matt white
phantom/matt black
black phantom/
matt white
black phantom/
matt black



The surfaces rose gold, bronze, phantom and black phantom may differ slightly from other product lines.

further options

- accessories for Occhio air from page 226

These and further options can be configured at
Occhio Digital Order System (DOS)

further information

- technical data, information on control
and on mounting options view pages 74–81

Mito linear

ceiling luminaires
alto side 40



side flat

for hollow ceiling,
height 32 mm, length 38 cm, 15 W (800 lm),
incl. remote converter



side up

for surface-mounted installation
height 52 mm, length 38 cm, 15 W (800 lm)
homogeneous wall illumination (wallwash)
incl. converter



side pure

recessed installation in hollow ceiling, incl. mounting board,
power supply integrated in luminaire
height 20 mm, length 38 cm, 15 W (800 lm)
incl. converter



side track

with in-trac adapter, for Eutrac, Erco and Zumtobel 3-phase tracks
height 52 mm, length 38 cm, 15 W (800 lm)
homogeneous wall illumination (wallwash)
incl. converter

colors	689,08
materials	+100,84
phantom/black phantom	+151,26

colors	739,50
materials	+117,65
phantom/black phantom	+176,47

colors	924,37
materials	+117,65
phantom/black phantom	+176,47

colors	823,53
--------	--------

alto side 70



side flat

for hollow ceiling,
height 32 mm, length 71 cm, 30 W (1600 lm),
incl. remote converter



side up

for surface-mounted installation
height 52 mm, length 71 cm, 30 W (1600 lm)
homogeneous wall illumination (wallwash)
incl. converter



side pure

recessed installation in hollow ceiling, incl. mounting board,
power supply integrated in luminaire
height 20 mm, length 38 cm, 15 W (800 lm)
incl. converter



side track

with in-trac adapter, for Eutrac, Erco and Zumtobel 3-phase tracks
height 52 mm, length 71 cm, 30 W (1600 lm)
homogeneous wall illumination (wallwash)
incl. converter

colors	924,37
materials	+151,26
phantom/black phantom	+226,89

colors	991,60
materials	+184,87
phantom/black phantom	+277,31

colors	1.210,08
materials	+184,87
phantom/black phantom	+277,31

colors	1.075,63
--------	----------

mounting options (included)



inlay
(flat/up)



»air« inlay
(up)



cover for ceiling box
(flat/up)

control

features

»color tune«, switch- and continuously dimmable
via Occhio air (optional)

Mito set box

color temperature 2700 K/3000 K/3500 K/4000 K
adjustable in steps, dimmable via trailing-edge phase
cut dimmer (not for »x-tra warm«)

Mito »air« box



Bluetooth control integrated in luminaire,
features via Occhio air app or »air« controller (optional)
controllable (no external dimming)

+82,35

Mito DALI box

version for building control system via DALI
version track: only for OneTrack by Eutrac/Stucchi track

+82,35

options

light source

high color LED CRI95

2700 K–4000 K
with set, »air« or
DALI box

● **2200 K–3500 K »x-tra warm«**
only with »air« or DALI box
L 40 cm +126,05
L 70 cm +189,08

lighting effects



wallwash

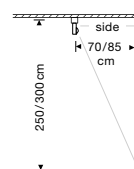

surfaces

head/inlay colors

matt white
matt white/matt black
matt black
matt black/matt white



matt silver
matt gold/matt white
matt gold/matt black



materials/phantom/black phantom

rose gold/matt white
rose gold/matt black
bronze/matt white
bronze/matt black



phantom/matt white
phantom/matt black
black phantom/
matt white
black phantom/
matt black



The surfaces rose gold, bronze, phantom and black phantom may differ slightly from other product lines.

further options

- accessories for Occhio air from page 226

These and further options can be configured at
Occhio Digital Order System (DOS)

further information

- technical data, information on control
and on mounting options view pages 74–81

Mito linear
ceiling luminaires
alto side 100



side flat

for hollow ceiling,
height 32 mm, length 104 cm, 45 W (2400 lm),
incl. remote converter

side up

for surface-mounted installation
height 52 mm, length 104 cm, 45 W (2400 lm)
homogeneous wall illumination (wallwash)
incl. converter

side pure

recessed installation in hollow ceiling, incl. mounting board,
power supply integrated in luminaire
height 20 mm, length 104 cm, 45 W (2400 lm)
incl. converter

side track

with in-trac adapter, for Eutrac, Erco and Zumtobel 3-phase tracks
height 52 mm, length 104 cm, 45 W (2400 lm)
homogeneous wall illumination (wallwash)
incl. converter

colors	1.176,47
materials	+184,87
phantom/black phantom	+277,31

colors	1.260,50
materials	+218,49
phantom/black phantom	+327,73

colors	1.512,61
materials	+218,49
phantom/black phantom	+327,73

colors	1.344,54
--------	----------

mounting options
(included)



inlay
(flat/up)



»air« inlay
(up)



cover for ceiling box
(flat/up)

control

features

»color tune«, switch- and continuously dimmable
via Occhio air (optional)

Mito set box

color temperature 2700 K/3000 K/3500 K/4000 K
adjustable in steps, dimmable via trailing-edge phase
cut dimmer (not for »x-tra warm«)

Mito »air« box



Bluetooth control integrated in luminaire,
features via Occhio air app or »air« controller (optional)
controllable (no external dimming)

+82,35

Mito DALI box

version for building control system via DALI
version track: only for OneTrack by Eutrac/Stucchi track

+82,35

options

light source

high color LED CRI95

2700 K–4000 K
with set, »air« or
DALI box

2200 K–3500 K »x-tra warm«
only with »air« or DALI box
+252,10

lighting effects



wallwash

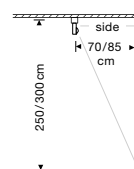

surfaces

head/inlay
colors

matt white
matt white/matt black
matt black
matt black/matt white



matt silver
matt gold/matt white
matt gold/matt black



materials/phantom/black phantom

rose gold/matt white
rose gold/matt black
bronze/matt white
bronze/matt black

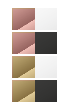

phantom/matt white
phantom/matt black
black phantom/
matt white
black phantom/
matt black



The surfaces rose gold, bronze, phantom and black phantom may differ slightly from other product lines.

further options

- accessories for Occhio air from page 226

These and further options can be configured at
Occhio Digital Order System (DOS)

further information

- technical data, information on control
and on mounting options view pages 74–81

Mito volo mounting options

volò flat
with flat base for mounting on hollow ceiling,
remote power supply

- ☺ synchronization of multiple luminaires via »air« sync possible (prerequisite all luminaires with »air« and same type)

☺ integrated set box (standard),
»air« box optional or DALI box

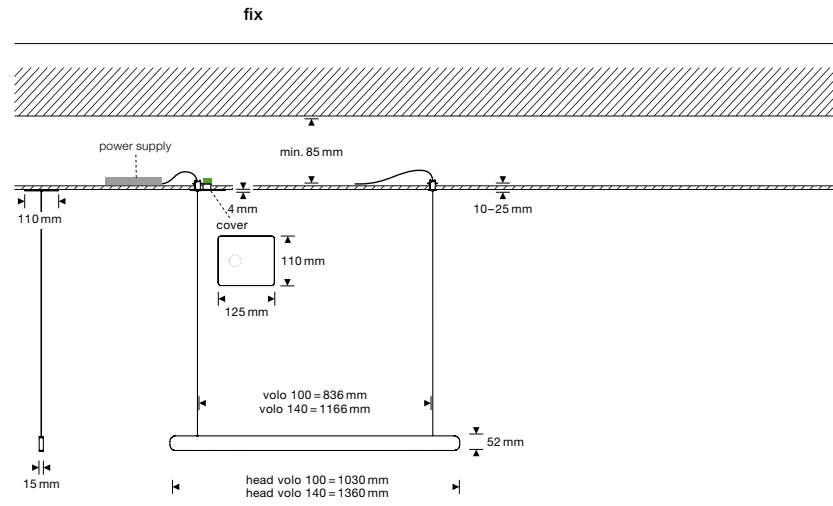

volò track
for track mounting in Eutrac, Erco and Zumtobel 3-phase track (DALI version only compatible with OneTrack by Eutrac/Stucchi track), with integrated power supply

- ☺ synchronization of multiple luminaires via »air« sync possible (prerequisite all luminaires with »air« and same type)

☺ integrated set box (standard),
»air« box optional or DALI box

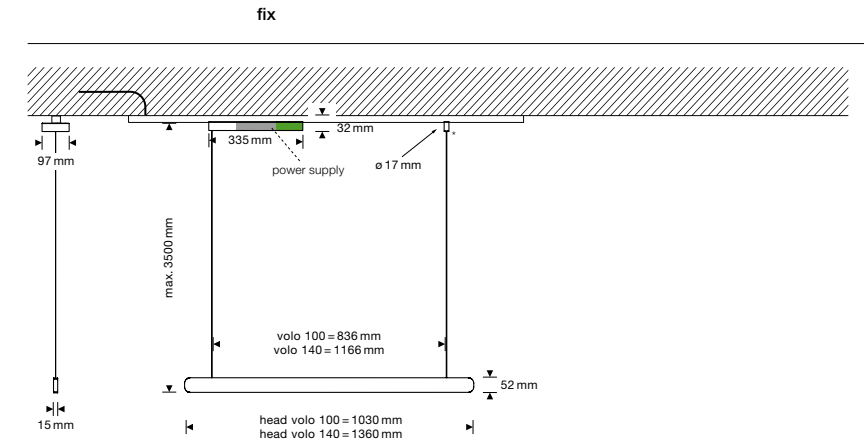

volò up
for surface mounting with integrated power supply, through-wiring possible

- ☺ synchronization of multiple luminaires via »air« sync possible (prerequisite all luminaires with »air« and same type)

☺ integrated set box (standard),
»air« box optional or DALI box

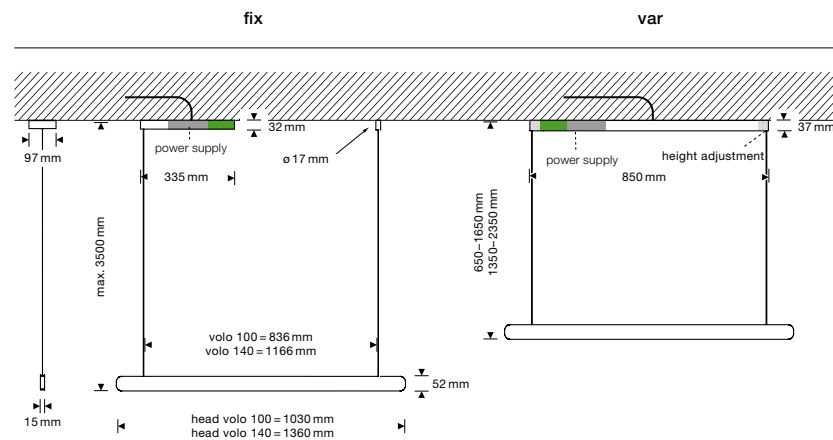

volò var pure
with plastering element for flush ceiling-mounted installation, with integrated power supply, through-wiring possible

- ☺ synchronization of multiple luminaires via »air« sync possible (prerequisite all luminaires with »air« and same type)

☺ integrated set box (standard),
»air« box optional or DALI box

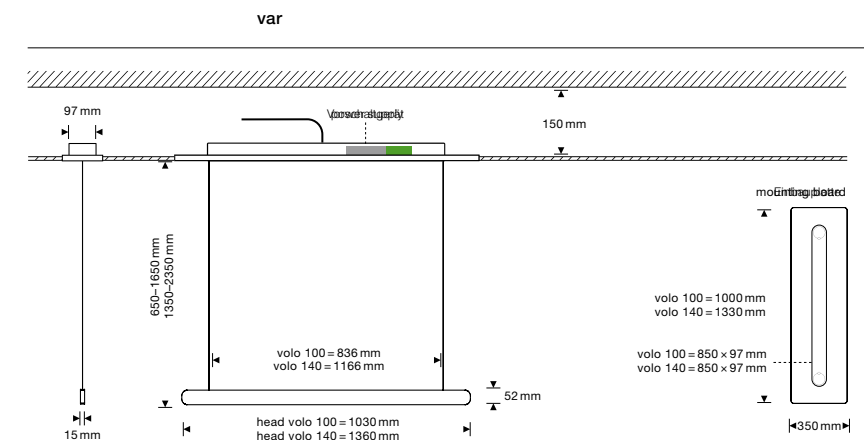

volò up midfeed
for surface mounted installation and midfeed with integrated power supply, through-wiring possible

- ☺ synchronization of multiple luminaires via »air« sync possible (prerequisite all luminaires with »air« and same type)

☺ integrated set box (standard),
»air« box optional or DALI box

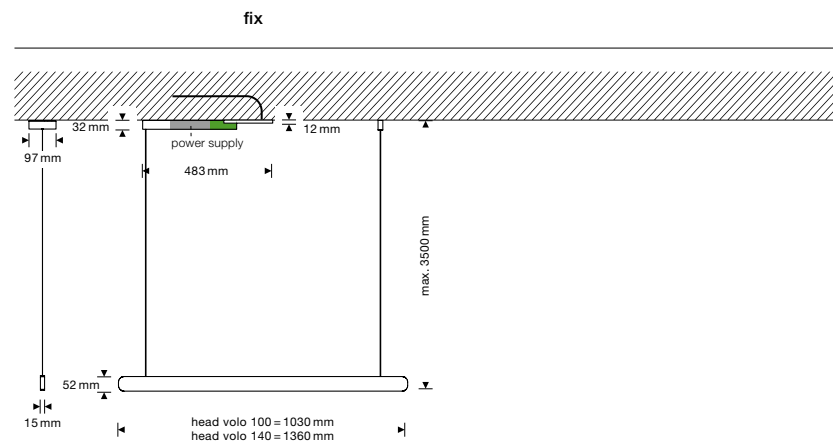

Mito alto mounting options

alto flat
for hollow ceiling mounting with remote power supply

 inclusive set box (standard),
»air« box optional or DALI box

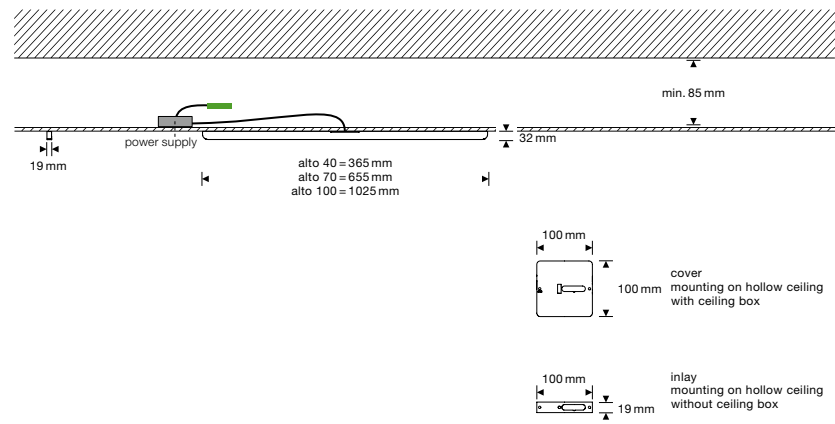

alto up
for surface mounting with integrated power supply

 integrated set box (standard),
»air« box optional or DALI box

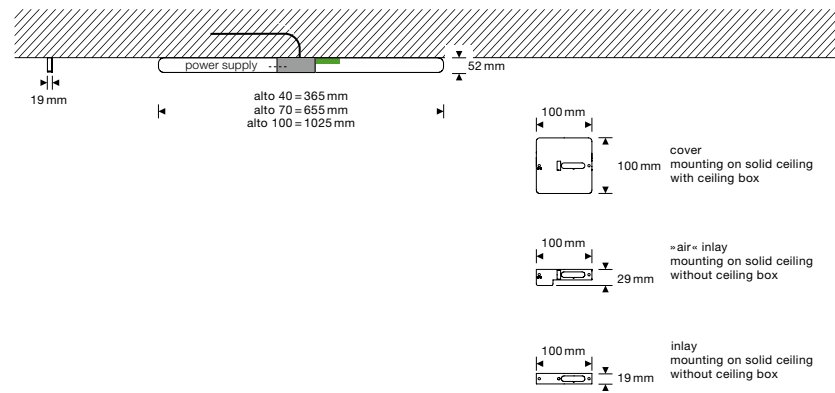

alto track
for track mounting in Eutrac, Erco and Zumtobel 3-phase track (DALI version only compatible with OneTrack by Eutrac/Stucchi track), with integrated power supply

 integrated set box (standard),
»air« box optional or DALI box

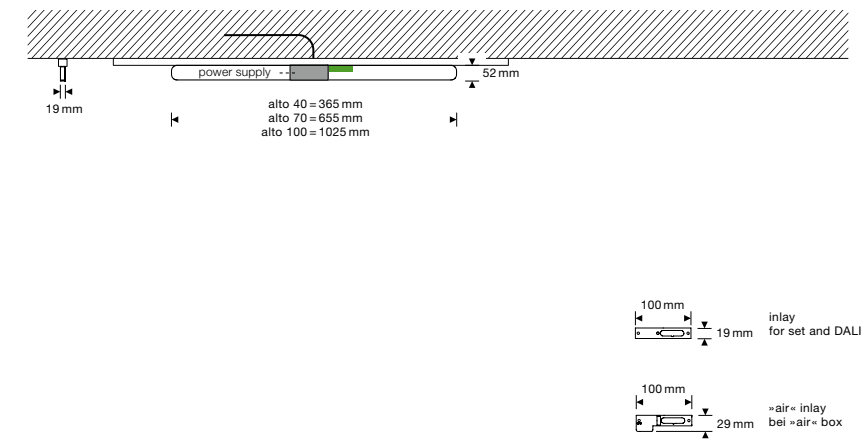

alto pure
for recessed mounting with plastering element with integrated power supply

 integrated set box (standard),
»air« box optional or DALI box

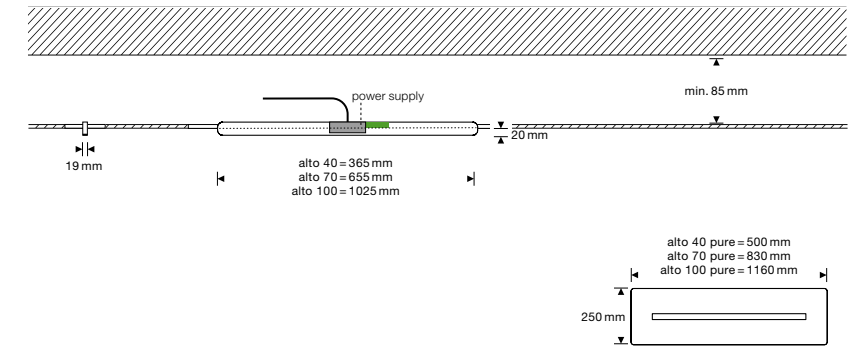

Mito alto side mounting options

alto side flat
for hollow ceiling mounting with remote power supply

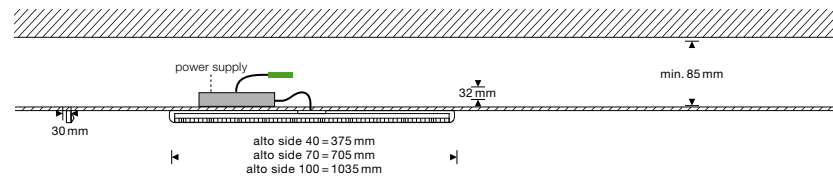

recommended wall distance
for homogenous wall illumination:

approx. 70 cm at 250 cm room height
approx. 85 cm at 300 cm room height

 inclusive set box (standard),
optional mit »air« box oder DALI box

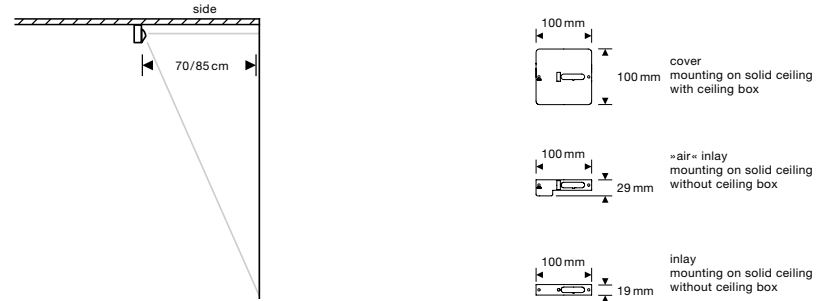

alto side up
for surface mounting with integrated power supply

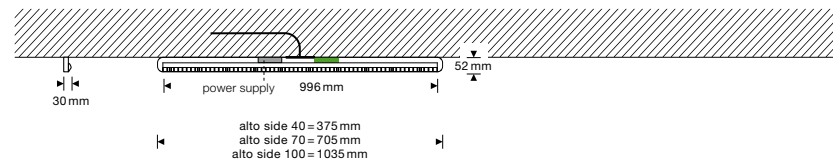

recommended wall distance
for homogenous wall illumination:

approx. 70 cm at 250 cm room height
approx. 85 cm at 300 cm room height

 integrated set box (standard),
»air« box optional or DALI box

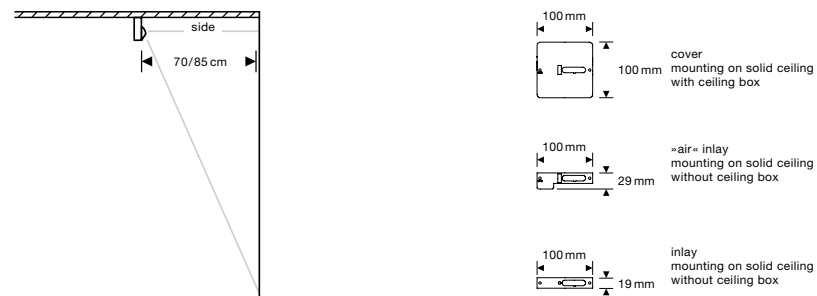

alto side track
for track mounting in Eutrac, Erco and Zumtobel 3-phase track (DALI version only compatible with OneTrack by Eutrac/Stucchi track), with integrated power supply

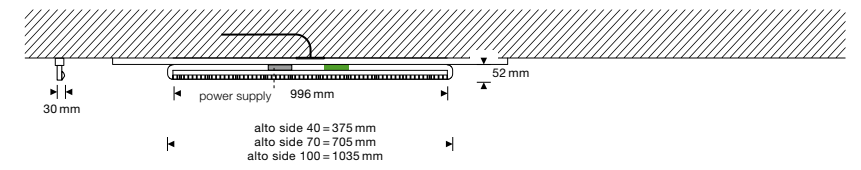

recommended wall distance
for homogenous wall illumination:

approx. 70 cm at 250 cm room height
approx. 85 cm at 300 cm room height

 integrated set box (standard),
»air« box optional or DALI box



alto side pure
for recessed mounting with plastering element with integrated power supply

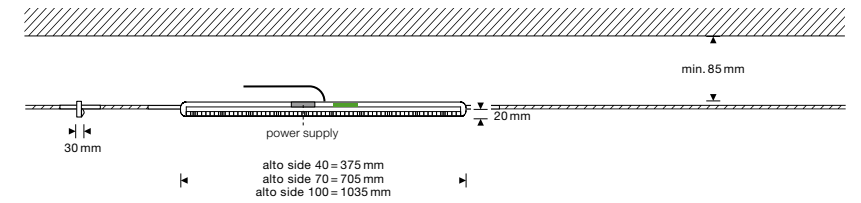

recommended wall distance
for homogenous wall illumination:

approx. 70 cm at 250 cm room height
approx. 85 cm at 300 cm room height

 integrated set box (standard),
»air« box optional or DALI box



Mito linear technical data

version »color tune«	connection	U	230V AC									
		W	volò 100	-45 W	volò 140	-60 W	alto/alto side 40	-15 W	alto/alto side 70	-30 W	alto/alto side 100	-45 W
average service life		t	> 50.000 h									
energy efficiency class		EEK	G									
LED color temperature	T	high color			x-tra warm							
Color Rendering Index	CRI	2700–4000K			2200–3500K							
recommended use		Ra 95			Ra 95							
		residential, public and office			residential							
power	P	15 W	30 W	45 W	56 W	60 W	70 W					
luminous flux luminaire	φ				(materials, phantom)		(colors)					
volò												
lighting effect table (wide)				2900 lm		3900 lm						
lighting effect room (narrow)				2800 lm		3700 lm						
alto												
lighting effect wide		800 lm	1600 lm	2400 lm								
lighting effect narrow		800 lm	1600 lm	2400 lm								
alto side												
lighting effect wallwash		800 lm	1600 lm	2400 lm								
terra/terra table top/terra 3d												
lighting effect table (wide)					3600 lm		4600 lm					

Mito linear control

control

Mito linear luminaires can be dimmed via »touchless control« (volò, terra), »body sensor« (terra) and Occhio air (standard for terra; optional for volò, alto). Alternatively dimming via trailing-edge phase cut* or DALI is possible (not terra).

Mito set box

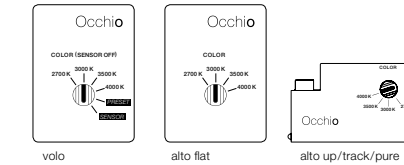

volò
COLOR (sensor off)
adjustable color temperature (4 steps),
trailing-edge phase cut dimming* possible

alto
COLOR
adjustable color temperature (4 steps)
trailing-edge phase cut dimming* possible

PRESET
adjustable color temperature (4 steps),
adjustable up/downlight ratio (5 steps)

SENSOR
»touchless control« (gesture control),
switching, dimming, »up/down fading«,
»color tune« (color temperature continuously adjustable),
no external dimming possible

Mito »air« box

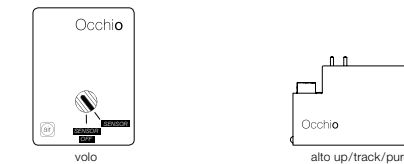

Occhio air control via Bluetooth—switching, dimming, »up/down fading« (volò, terra) and »color tune« of individual luminaires, groups and scenes.

volò
SENSOR
»air« + »touchless control« (Bluetooth and gesture control),
control via »touchless control« and Occhio air app or »air« controller,
switching, dimming, »up/down fading«,
»color tune« (color temperature continuously adjustable)

alto
»air« (Bluetooth control),
control via Occhio air app or »air« controller,
switching, dimming,
»color tune« (color temperature continuously adjustable)

SENSOR OFF
»air« (Bluetooth control),
control via Occhio air app or »air« controller,
switching, dimming, »up/down fading«,
»color tune« (color temperature continuously adjustable)

terra/terra 3d/terra table top
Bluetooth control integrated in power supply
»air« + »touchless control« (Bluetooth and gesture control) and »body sensor«,
control via »touchless control«, »body sensor« and Occhio air app or »air« controller,
switching, dimming, »up/down fading«,
»color tune« (color temperature continuously adjustable)

»ambient light control«
adaption to ambient light

»presence sensor«
presence recognition and automatic switch-off via motion sensor

control and sensors via Occhio »air«, App deactivable and adjustable

No external dimming possible with Mito »air« box

Mito DALI box

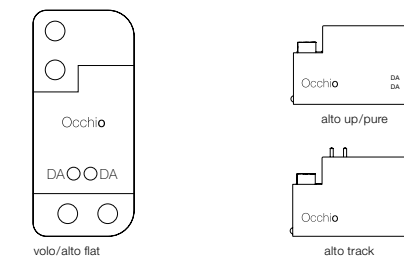

control via DALI

volò
– adjustable color temperature**
– continuously dimmable
– uplight and downlight separately controllable (two DALI addresses required)
– no »touchless control«, no »up/down fading«

alto
– adjustable color temperature**
– continuously dimmable

*compatible dimmers: www.occhio.com/dim
**A DALI controller »DALI device type 8 (DT8)« is required to control the light color. Further information can be found at www.occhio.com/dali

X series

Gioia

New Horizons – infinite mobility, fascinating weightlessness and an almost sculptural appearance. Gioia, that means joy – joy in the magic of perfect light.

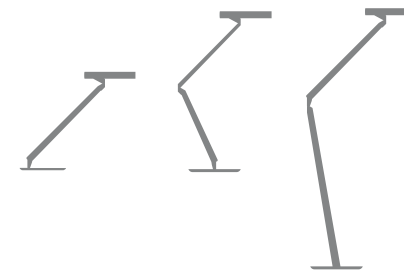

Gioia
table luminaires

Gioia
reading luminaire



tavolo

height head adjustable: 28–75 cm,
ø head 30 cm, 30 W (1830 lm),
head and body 360° rotatable

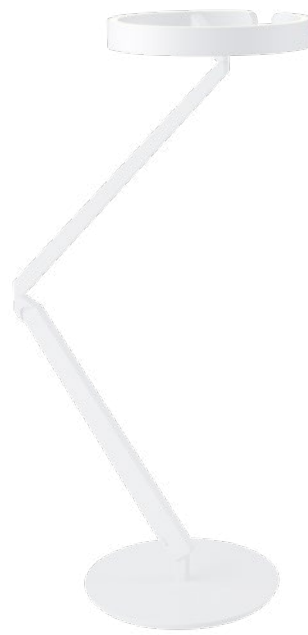

equilibrio

height head adjustable: 62–96 cm,
ø head 30 cm, 30 W (1830 lm),
head and body 360° rotatable



lettura

height head adjustable: 120–166 cm,
ø head 30 cm, 30 W (1830 lm),
head and body 360° rotatable

colors	2.084,03
materials	+168,07
phantom/black phantom	+252,10

2.974,79
Occhio air 
Bluetooth control integrated in power supply, features controllable via Occhio air app or »air« controller, no external dimming

3.310,92
+168,07
+252,10

control	features
	»color tune«, »up/down fading«, »focus light«, switch- and dimmable via »touchless control«, additionally controllable via Occhio air (included)



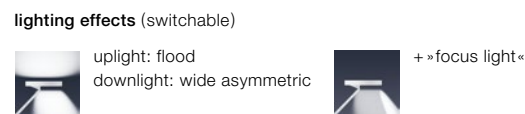

options	light source
	»color tune« 2700K–4000K







desk mount (only Gioia tavolo)
for inserted mounting in table tops, thickness 10–45 mm -134,46

surfaces

**head/body+base
colors**

matt white/matt white	
matt black/matt black	
matt silver/matt black	
matt gold/matt white	
matt gold/matt black	

materials/phantom/black phantom

rose gold/matt black	
bronze/matt black	
phantom/matt black	
black phantom/matt black	

The surfaces rose gold, bronze, phantom and black phantom may differ slightly from other product lines.

further options These and further options can be configured at **Occhio Digital Order System (DOS)**

further information - technical data, information on control and mounting options view pages 86–87

Gioia mounting options

desk mount (optional for Gioia tavolo)
for inserted mounting in table tops,
thickness 10–45 mm

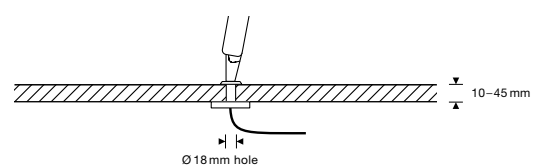

- 134,46

Gioia technical data and control

version »color tune«

connection	U	230 V AC
	W	30 W
average service life	t	> 50.000 h
energy efficiency class	EEK	G

LED		high color
color temperature	T	2700–4000 K
Color Rendering Index	CRI	Ra 95
recommended use		residential, public and office

power	P	24 W (LED)
luminous flux luminaire	ϕ	

lighting effect switchable		
lighting effect wide		1830 lm
lighting effect »focus light«		610 lm

control

Gioia luminaires can be dimmed via »touchless control« and Occhio air (standard).
A second »touchless control« sensor allows to switch the lighting effect between wide and »focus light«.

Gioia »air« box (standard)



Gioia

*Occhio air
powered by
Casambi*

 **Occhio air** control via Bluetooth—switching, dimming, »up/down fading« and »color tune« of individual luminaires, groups and scenes as well as »focus light«

Taglio tavolo/tavolo fix
Bluetooth control integrated in power supply »air«
+ »touchless control« (Bluetooth and gesture control)
control via »touchless control« and Occhio air app or
»air« controller, switching, dimming, »up/down fading«,
»color tune« (color temperature continuously adjustable),
»focus light« (switchable lighting effect)

control and sensors via Occhio air,
app deactivable and adjustable

No external dimming

X series

Taglio

Absolute clarity: striking, linear design combined with fascinating mobility and maximum »joy of use« create focus on the essence.



Taglio

table luminaires



tavolo fix

height head: 52 cm,
head 47 cm, 20 W (1020 lm),
head and body 360° rotatable



tavolo

height head adjustable: 33–72 cm
head 47 cm, 20 W (1020 lm),
head and body 360° rotatable

colors	789,92
materials	+84,03
phantom/black phantom	+126,05

1.159,66
+84,03
+126,05

control	features	Occhio air (optional) 
	»color tune«, »up/down fading«, switch- and dimmable via »touchless control«, additionally controllable via Occhio air (optional)	Bluetooth control integrated in power supply, features controllable via Occhio air app or »air« controller, no external dimming +82,35

options	light source
	»color tune« 2700 K–4000 K
lighting effects	uplight: flood
	downlight: wide asymmetric

desk mount
for inserted mounting in table tops, thickness 10–45 mm -134,46

surfaces

head/body+base colors	
matt white/matt white	
matt black/matt black	
matt silver/matt black	
matt gold/matt white	
matt gold/matt black	

materials/phantom/black phantom	
rose gold/matt black	
bronze/matt black	
phantom/matt black	
black phantom/matt black	

The surfaces rose gold, bronze, phantom and black phantom may differ slightly from other product lines.

further options These and further options can be configured at **Occhio Digital Order System (DOS)**

further information - technical data, information on control and mounting options view pages 92–93

Taglio mounting options

desk mount (optional)
for inserted mounting in table tops,
thickness 10–45 mm

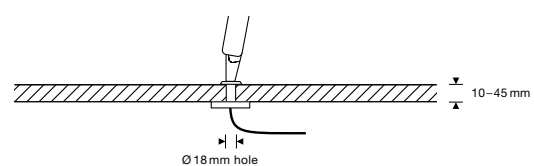

-134,46

Taglio technical data and control

version »color tune«

connection	U	230 V AC
	W	20 W
average service life	t	> 50.000 h
energy efficiency class	EEK	G

LED		high color
color temperature	T	2700–4000 K
Color Rendering Index	CRI	Ra 95
recommended use		residential, public and office

power	P	15 W (LED)
luminous flux luminaire	φ	

lighting effect wide 1020 lm

control

Taglio luminaires can be dimmed via »touchless control« and Occhio air.

Taglio »air« box

 **Occhio air** control via Bluetooth – switching, dimming, »up/down fading« and »color tune« of individual luminaires, groups and scenes.

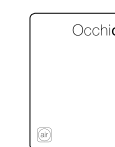

Taglio

*Occhio air
powered by
Casambi*

Taglio tavolo/tavolo fix
Bluetooth control integrated in power supply »air«
+ »touchless control« (Bluetooth and gesture control)
control via »touchless control« and Occhio air app or
»air« controller, switching, dimming, »up/down fading«,
»color tune« (color temperature continuously adjustable)

control and sensors via Occhio air,
app deactivable and adjustable

No external dimming

L series

Sento

The innovative, modular luminaire system for residential and public areas. With Sento you can define light precisely and thus make your own design statement.

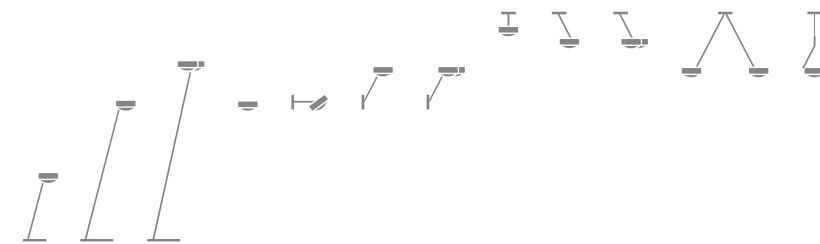

Sento

table- and floor luminaires



head 360° rotatable
body turnable (can be fixed)
incl. plug-in power supply

60 cm swivel range 40° Ⓢ can be synced via Occhio air	80 cm swivel range 40°	125 cm swivel range 18° Ⓢ can be synced via Occhio air	160 cm swivel range 12°
--	----------------------------------	---	-----------------------------------

heads 360° rotatable body turnable (can be fixed) incl. controller Ⓢ can be synced via Occhio air	180 cm swivel range 12°
--	-----------------------------------

versions

	18 W (1170 lm)	chrome/colors	1.186,55	1.243,70	1.378,15	1.462,18	2 x 26 W (2 x 1620 lm)	2.336,13
		materials	+67,23					+134,45
		phantom/black phantom	+100,84					+201,68

E

diffusor glass/lens 80°

	18 W (1270 lm)	chrome/colors	1.235,29	1.292,44	1.426,89	1.510,92	2 x 26 W (2 x 1620 lm)	2.433,61
		materials	+67,23					+134,45
		phantom/black phantom	+100,84					+201,68

D

lens 80°

orientation: left/right selectable

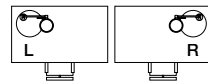

orientation: left/right selectable



control

features

»up/down fading« (with double-sided light output), switchable and dimmable via »touchless control« or Occhio air (optional), power 18/26 W switchable (tavolo and lettura only 18 W)

Occhio air



Bluetooth control integrated directly in the head, features via Occhio air app or »air« controller (optional)

+82,35

inserts

	filter red	35,29
	filter green	
	filter blue	
	filter yellow	
	filter magenta	
(max. 18 W)		

	soft edge glass (for lens) light cone with soft contour approx. 80°	28,57
	satinised glass (for lens) light cone with soft contour approx. 100°	18,49

options

light source

2700 K or 3000 K, perfect color LED CRI 97

surfaces

head

chrome/colors

shiny chrome
matt chrome
glossy white
matt white
matt black



materials

matt gold
matt gold



rose gold



bronze



phantom



black phantom



phantom/black phantom

phantom



black phantom



body/base

shiny chrome
matt chrome
shiny chrome/glossy white
matt white
matt black



The surfaces rose gold, bronze, phantom and black phantom may differ slightly from other product lines.

further options

- further lighting effects view page 110
- accessories for Occhio air from page 226

These and further options can be configured at
Occhio Digital Order System (DOS)

further information

- technical data and information on control view page 111

Sento

wall luminaires



verticale



letto

head 360° rotatable

up/flat

📶 can be synced via Occhio air

20 cm, up/flat
swivel range 105°

30 cm, up/flat
swivel range 115°

40 cm, up/flat
swivel range 140°

📶 can be synced via Occhio air

versions

	26 W (1620 lm)	chrome/colors	662,18
		materials	+67,23
		phantom/black phantom	+100,84

E

diffusor glass/lens 80°

	26 W (1750 lm)	chrome/colors	710,92
		materials	+67,23
		phantom/black phantom	+100,84

D

lens/lens
80°/80°

	26 W (1570 lm)	chrome/colors	573,11
		materials	+67,23
		phantom/black phantom	+100,84

C

lens
80°

with carbon handle (incl.)

with fixing ring (price reduction) -5,04

orientation: left/right selectable (view from above)

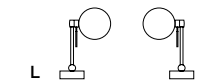

control

features

»up/down fading« (with double-sided light output), switchable and dimmable via »touchless control« (can be deactivated) or Occhio air (optional), alternatively dimmable via trailing-edge phase cut dimmer

Occhio air



Bluetooth control integrated in the head, features via Occhio air app or »air« controller (optional), no external dimming

+82,35

inserts

	filter red	35,29
	filter green	
	filter blue	
	filter yellow	
	filter magenta	
(max. 18 W)		

	soft edge glass (for lens) light cone with soft contour approx. 80°	28,57
	satinised glass (for lens) light cone with soft contour approx. 100°	18,49

options

light source

2700 K or 3000 K, perfect color LED CRI 97

mounting options



with integrated converter for surface mounting, through-wiring possible



with flat base for hollow wall with cavity box (incl. remote converter)

surfaces

head

chrome/colors
shiny chrome
matt chrome
glossy white
matt white
matt black

materials

matt gold
matt gold
rose gold
bronze

phantom/black phantom

phantom
black phantom

body/base

shiny chrome
matt chrome
shiny chrome/glossy white
matt white
matt black

The surfaces rose gold, bronze, phantom and black phantom may differ slightly from other product lines.

further options

- further lighting effects view page 110
- further mounting accessories view page 108
- accessories for Occhio air from page 226

These and further options can be configured at **Occhio Digital Order System (DOS)**

further information

- technical data, information on control and mounting options view pages 109–111

Sento

wall luminaires



parete singolo



parete doppio

head 360° rotatable

20 cm, up/flat
swivel range 120°

30 cm, up/flat
swivel range 120°

40 cm, up/flat
swivel range 120°

📶 can be synced via Occhio air

20 cm, up/flat
swivel range 120°

30 cm, up/flat
swivel range 120°

40 cm, up/flat
swivel range 120°

📶 can be synced via Occhio air

versions



26 W (1620 lm)

chrome/colors

783,19

791,60

801,68

2 x 26 W (2 x 1620 lm)

1.381,51

1.388,24

1.396,64

materials

+67,23

phantom/black phantom

+100,84

+134,45

+201,68

E

diffusor glass/lens 80°



26 W (1750 lm)

chrome/colors

831,93

840,34

850,42

2 x 26 W (2 x 1750 lm)

1.478,99

1.485,71

1.494,12

materials

+67,23

phantom/black phantom

+100,84

+134,45

+201,68

D

lens/lens
80°/80°



26 W (1570 lm)

chrome/colors

694,12

702,52

712,61

2 x 26 W (2 x 1570 lm)

1.203,36

1.210,08

1.218,49

materials

+67,23

phantom/black phantom

+100,84

+134,45

+201,68

C

lens
80°

control

features

»up/down fading« (with double-sided light output), switchable and dimmable via »touchless control« (can be deactivated) or Occhio air (optional), dimmable via trailing-edge phase cut dimmer

Occhio air



Bluetooth control integrated in the head, features via Occhio air app or »air« controller (optional), no external dimming

+82,35

inserts

— filter red 35,29
— filter green
— filter blue
— filter yellow
— filter magenta
 (max. 18 W)

— soft edge glass (for lens) 28,57
 light cone with soft contour approx. 80°
— satinised glass (for lens) 18,49
 light cone with soft contour approx. 100°

options

light source

2700 K or 3000 K, perfect color LED CRI 97

mounting options

up

with integrated converter for surface mounting, through-wiring possible

flat

with flat base for hollow wall with cavity box (incl. remote converter)

surfaces

head

chrome/colors

shiny chrome
matt chrome
glossy white
matt white
matt black

materials

— matt gold
— matt gold
— rose gold
— bronze
—

phantom/black phantom

— phantom
— black phantom

body/base

— shiny chrome
— matt chrome
— shiny chrome/glossy white
— matt white
— matt black

The surfaces rose gold, bronze, phantom and black phantom may differ slightly from other product lines.

further options

- further lighting effects view page 110
 - further mounting accessories view page 108
 - accessories for Occhio air from page 226

These and further options can be configured at **Occhio Digital Order System (DOS)**

further information

- technical data, information on control and mounting options view pages 109–111

Sento

ceiling luminaires



soffitto singolo

soffitto doppio

head 360° rotatable
body 180° rotatable

30 cm, up/flat swivel range 120°
40 cm, up/flat swivel range 120°
60 cm, up/flat swivel range 120°
80 cm, up/flat swivel range 90°
☺ can be synced via Occhio air

30 cm, up/flat swivel range 120°
40 cm, up/flat swivel range 120°
60 cm, up/flat swivel range 120°
80 cm, up/flat swivel range 90°
☺ can be synced via Occhio air

versions

version	power	chrome/colors	materials	phantom/black phantom	30 cm	40 cm	60 cm	80 cm	2 x 30 cm	2 x 40 cm	2 x 60 cm	2 x 80 cm	
E diffusor glass/lens 80°	26 W (1620 lm)	831,93	+67,23	+100,84	842,02	862,18	878,99		2 x 26 W (2 x 1620 lm)	1.428,57 +134,45 +201,68	1.436,97	1.457,14	1.477,31
D lens/lens 80°/80°	26 W (1750 lm)	880,67	+67,23	+100,84	890,76	910,92	927,73		2 x 26 W (2 x 1750 lm)	1.526,05 +134,45 +201,68	1.534,45	1.554,62	1.574,79
C lens 80°	26 W (1570 lm)	742,86	+67,23	+100,84	752,94	773,11	789,92		2 x 26 W (2 x 1570 lm)	1.250,42 +134,45 +201,68	1.258,82	1.278,99	1.299,16

control

features

»up/down fading« (with double-sided light output), switchable and dimmable via »touchless control« (can be deactivated) or Occhio air (optional), dimmable via trailing-edge phase cut dimmer

Occhio air

Bluetooth control integrated in the head, features via Occhio air app or »air« controller (optional), no external dimming

+82,35

inserts

filter red 35,29
filter green
filter blue
filter yellow
filter magenta
(max. 18 W)

soft edge glass (for lens) light cone with soft contour approx. 80° 28,57
satinised glass (for lens) light cone with soft contour approx. 100° 18,49

options

light source

2700 K or 3000 K, perfect color LED CRI 97

mounting options

up

with integrated converter for surface mounting, through-wiring possible

flat

with flat base for hollow ceiling with cavity box (incl. remote converter)

surfaces

head

chrome/colors
shiny chrome
matt chrome
glossy white
matt white
matt black

materials

matt gold
matt gold
rose gold
bronze

phantom/black phantom

phantom
black phantom

body/base

shiny chrome
matt chrome
shiny chrome/glossy white
matt white
matt black

The surfaces rose gold, bronze, phantom and black phantom may differ slightly from other product lines.

further options

- further lighting effects view page 110
- further mounting accessories view page 108
- accessories for Occhio air from page 226

These and further options can be configured at **Occhio Digital Order System (DOS)**

further information

- technical data, information on control and mounting options view pages 109–111

Sento

ceiling luminaires



soffitto due

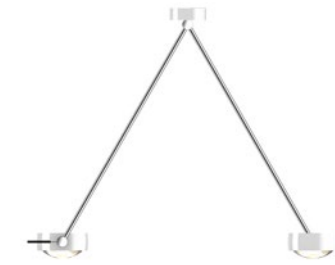

soffitto due

head 360° rotatable
body 180° rotatable

30 cm, up/flat swivel range 2 x 60°
40 cm, up/flat swivel range 2 x 60°
60 cm, up/flat swivel range 2 x 60°

☺ can be synced via Occhio air

80 cm, up/flat swivel range 2 x 45°
100 cm, up/flat swivel range 2 x 45°
125 cm, up/flat swivel range 2 x 45°

☺ can be synced via Occhio air

versions

Version	Power	Material	30 cm	40 cm	60 cm	80 cm	100 cm	125 cm
E diffusor glass/lens 80°	2 x 26 W (2 x 1620 lm)	chrome/colors	1.524,37	1.547,90	1.586,55	1.626,89	1.675,63	1.727,73
		materials	+134,45			+134,45		
		phantom/black phantom	+201,68			+201,68		
D lens/lens 80°/80°	2 x 26 W (2 x 1750 lm)	chrome/colors	1.621,85	1.645,38	1.684,03	1.724,37	1.773,11	1.825,21
		materials	+134,45			+134,45		
		phantom/black phantom	+201,68			+201,68		
C lens 80°	2 x 26 W (2 x 1570 lm)	chrome/colors	1.346,22	1.369,75	1.408,40	1.448,74	1.497,48	1.549,58
		materials	+134,45			+134,45		
		phantom/black phantom	+201,68			+201,68		

control	features	Occhio air	inserts
	»up/down fading« (with double-sided light output), switchable and dimmable via »touchless control« (can be deactivated) or Occhio air (optional), dimmable via trailing-edge phase cut dimmer	Bluetooth control integrated in the head, features via Occhio air app or »air« controller (optional), no external dimming +82,35	<ul style="list-style-type: none"> filter red 35,29 filter green filter blue filter yellow filter magenta (max. 18 W)

options	light source	mounting options	surfaces	body/base
	2700 K or 3000 K, perfect color LED CRI 97	up with integrated converter for surface mounting, through-wiring possible flat with flat base for hollow ceiling with cavity box (incl. remote converter)	head chrome/colors: shiny chrome, matt chrome, glossy white, matt white, matt black materials: matt gold, rose gold, bronze phantom/black phantom: phantom, black phantom soft edge glass (for lens) light cone with soft contour approx. 80° 28,57 satinised glass (for lens) light cone with soft contour approx. 100° 18,49	shiny chrome matt chrome shiny chrome/glossy white matt white matt black

The surfaces rose gold, bronze, phantom and black phantom may differ slightly from other product lines.

further options - further lighting effects view page 110
- further mounting accessories view page 108
- accessories for Occhio air from page 226

These and further options can be configured at **Occhio Digital Order System (DOS)**

further information - technical data, information on control and mounting options view pages 109–111

Sento

ceiling luminaires



faro

head and body
360° rotatable

10 cm, up/flat **20 cm, up/flat** **30 cm, up/flat**

📶 can be synced via Occhio air

versions

	2 x 26 W (2 x 1620 lm)	chrome/colors	739,50	746,22	754,62
		materials	+67,23		
		phantom/black phantom	+100,84		

E
diffusor glass/lens 80°

	2 x 26 W (2 x 1750 lm)	chrome/colors	788,24	794,96	803,36
		materials	+67,23		
		phantom/black phantom	+100,84		

D
lens/lens
80°/80°

	2 x 26 W (2 x 1570 lm)	chrome/colors	650,42	657,14	665,55
		materials	+67,23		
		phantom/black phantom	+100,84		

C
lens
80°

control **features**

»up/down fading« (with double-sided light output), switchable and dimmable via »touchless control« (can be deactivated) or Occhio air (optional), dimmable via trailing-edge phase cut dimmer

Occhio air

Bluetooth control integrated in the head, features via Occhio air app or »air« controller (optional), no external dimming

+82,35

Sento

suspended luminaires



filo

head and body
360° rotatable
📶 can be synced via Occhio air

fix, up/flat
cable length adjustable during mounting
80–180 cm

variable, up/flat
continuous height adjustment
50–200 cm

	26 W (1620 lm)		873,95	1.159,66
		materials	+67,23	
		phantom/black phantom	+100,84	

	26 W (1750 lm)		922,69	1.208,40
		materials	+67,23	
		phantom/black phantom	+100,84	

	26 W (1570 lm)		784,87	1.070,59
		materials	+67,23	
		phantom/black phantom	+100,84	

longer version, fix (180–280 cm) configurable (surcharge)

inserts

	filter red	35,29
	filter green	
	filter blue	
	filter yellow	
	filter magenta	

(max. 18 W)

	soft edge glass (for lens) light cone with soft contour	28,57
	satinised glass (for lens) light cone with soft contour approx. 100°	18,49

options **light source**

2700 K or 3000 K, perfect color LED CRI 97

mounting options

up

with integrated converter for surface mounting, through-wiring possible

flat

with flat base for hollow ceiling with cavity box (incl. remote converter)

surfaces

head

chrome/colors

	shiny chrome
	matt chrome
	glossy white
	matt white
	matt black

materials

	matt gold
	rose gold
	bronze

phantom/black phantom

	phantom
	black phantom

body/base

	shiny chrome
	matt chrome
	shiny chrome/glossy white
	matt white
	matt black

The surfaces rose gold, bronze, phantom and black phantom may differ slightly from other product lines.







further information

- further lighting effects view page 110
- further mounting accessories view page 108
- accessories for Occhio air from page 226

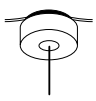
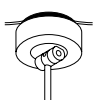
These and further options can be configured at **Occhio Digital Order System (DOS)**

further information - technical data, information on control and mounting options view pages 109–111

Sento mounting accessories

sideways inlet (single- or double-sided) through-wiring set for all surface-mounted versions, H 7 mm, ø 76 mm (ø base 88 mm)		white	28,57
for all up doppio/duo surface-mounted versions, H 7 mm, ø 107 mm (ø base 108 mm)		white	38,66
canopy with outlet on one or both sides for all surface-mounted versions, H 15 mm, ø 88 mm		shiny chrome glossy white matt chrome matt white matt black	55,46
cable redirection for filo, H 18 mm, ø 15 mm		shiny chrome matt chrome matt white matt black	35,29
mirror assembly kit for mounting the luminaires Sento verticale/parete 20/30 cm directly on a mirror, (drilling diameter 70 mm), no possibility of revision of the power supply via mirrors for flat versions			43,70
fixing ring to avoid rotation of the head, instead of carbon handle		shiny chrome matt chrome matt white matt black	11,76
cavity box for mounting of flat luminaires in hollow ceilings and -walls			3,36
inserts (color filter only for heads 18W)	filter red filter green filter blue filter yellow filter magenta		35,29
in combination with lens	soft edge glass (light cone with soft contour) satinised glass (soft widening of the light cone approx. 100°)		28,57 18,49

Can be configured at **Occhio Digital Order System (DOS)**

Sento mounting options

head ø 123 mm, H 42 mm

up
 with integrated power supply for surface mounting,
 through-wiring possible.

Ⓢ synchronization of multiple luminaires via
 »air« sync possible (prerequisite all luminaires
 with »air« and same type)

 Occhio air optional

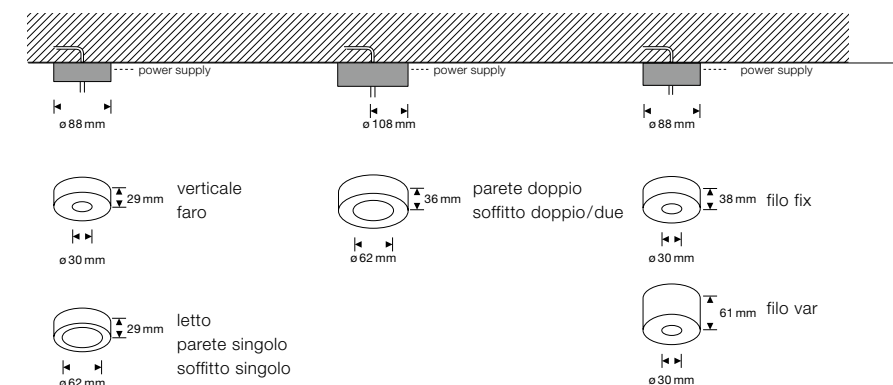

flat
 with flat base for cavity box,
 remote power supply

Ⓢ synchronization of multiple luminaires via
 »air« sync possible (prerequisite all luminaires
 with »air« and same type)

 Occhio air optional

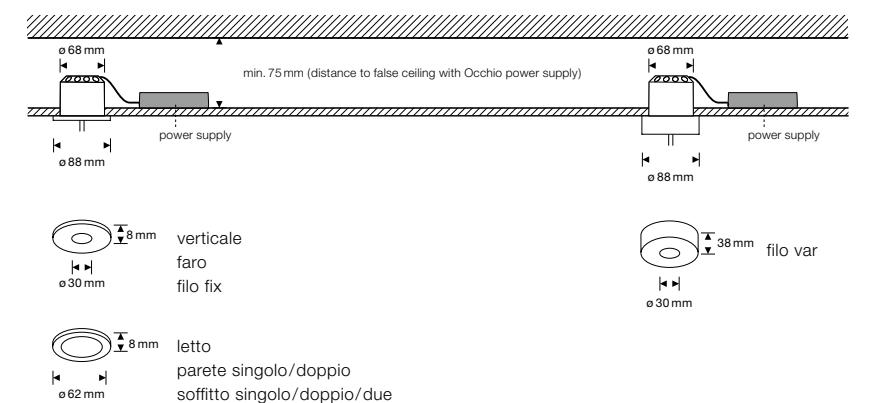

Sento lighting effects (can be configured)

head	+ soft edge glass	+ satinised glass
head with double-sided light output incl. »touchless control« (can be deactivated) with optional »air« control	A diffusor glass/diffusor glass diffus/diffus	
	D lens/lens 80°/80°	D lens/lens + 2 x satinised glass 80°/80°
	E diffusor glass/lens diffuse/80°	E diffusor glass/lens + soft edge glass diffuse/80°
		D lens/lens + 2 x satinised glass 100°/100°
		E diffusor glass/lens + satinised glass diffus/100
head with single-sided light output with »touchless control« (can be deactivated) or with optional »air« control	B diffusor glass diffus	
	C lens 80°	C lens + soft edge glass 80°
		C lens + satinised glass 100°
	S 40 double lens + soft edge glass 40° (not combinable with other inserts)	
	S 30 double lens + Fresnel-lens 30° (not combinable with other inserts)	

Sento technical data and control

version »touchless control«

connection	U	230 V AC
average service life	t	> 50.000 h
energy efficiency class	EEK	G

LED		perfect color
color temperature	T	2700 K, 3000 K
Color Rendering Index	CRI	Ra 97
recommended use		residential and public

	P	perfect color	
power		18 W	26 W
luminous flux luminaire	φ		
lighting effects A		1090 lm	1500 lm
lighting effects B		1000 lm	1370 lm
lighting effects C		1140 lm	1570 lm
lighting effects D		1270 lm	1750 lm
lighting effects E		1170 lm	1620 lm
lighting effects S 40		1130 lm	1560 lm
lighting effects S 30		1110 lm	1530 lm

control

with Occhio power supply

The Occhio converter is perfectly matched to these requirements and can be dimmed by trailing-edge phase cut dimmer*. Can not be used in conjunction with »touchless control« or Occhio air.

table/floor luminaires (Sento tavolo, Sento lettura, Sento terra)

Sento tavolo and lettura come with a plug-in power supply (max. 18 W, tavolo, lettura). Sento terra comes with a controller and touch surfaces (max. 2 x 26 W). The luminaires can be switched or dimmed on the luminaire head additionally via the controller and foot switch (only terra).

Occhio air
powered by
Casambi

 **Occhio air**
control via Bluetooth – switching, dimming, »up/down fading«
of individual luminaires, groups and scenes.

touchless dimm function
Sento luminaire heads

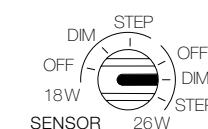

18 W/26 W
light power is adjustable to 18 W or 26 W,
18 W recommended for arm's area,
26 W not recommended for arm's reach (heat development).**

SENSOR OFF

luminaires are dimmed using remote trailing-edge phase cut dimmers* (except floor and table luminaires) or controlled with Occhio air (optional) (switching, dimming, »up/down fading«).

SENSOR DIM

luminaires can be controlled touchlessly »touchless control« via simple gestures control function integrated in the head or by Occhio air (optional) (switching, dimming, »up/down fading«).

SENSOR STEP

this setting enables the up/down ratio and brightness to be preconfigured and saved. Additionally dimmable via trailing-edge phase cut dimmer*.

*compatible dimmers: occhio.com/dim

**Sento tavolo, Sento lettura only with 18 W

L series

Sento sospeso

Completed in design, with sophisticated operating functions and an incomparable height adjustment: is the essence of highest quality of light.

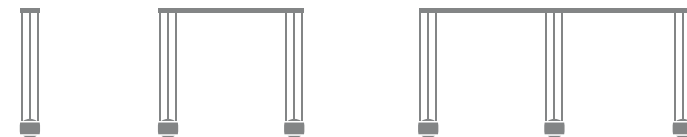

Sento sospeso

suspended luminaires

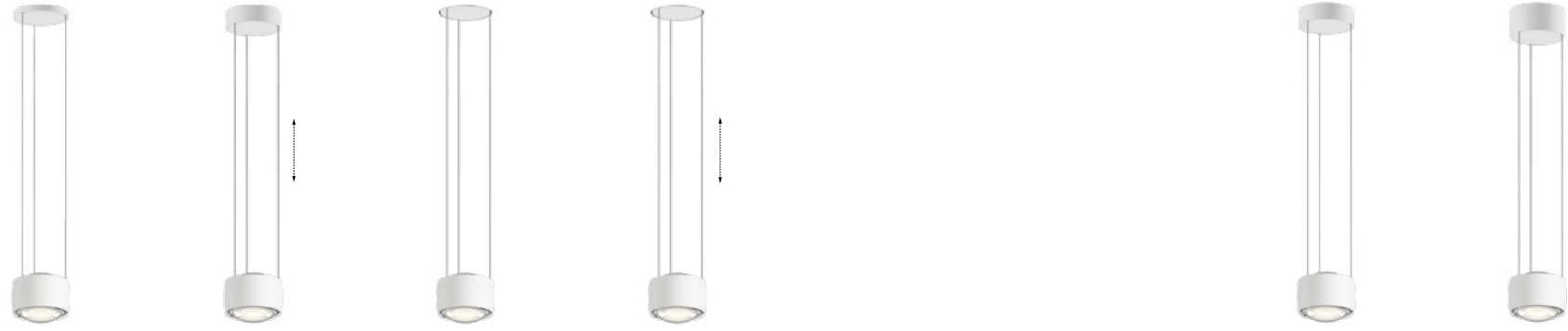

flat

pure

up

fix fix cable length adjustable during mounting max. 350 cm	fix for hollow ceiling incl. remote converter	variable	fix for flush ceiling-mounted installation (mounting board) incl. converter	variable	fix for surface-mounted installation through-wiring possible	variable
variable continuous height adjustment 50–200 cm	Ⓢ can be synced via Occhio air		Ⓢ can be synced via Occhio air		Ⓢ can be synced via Occhio air	

versions									
	32 W (1940 lm)	chrome/colors	1.183,19	1.537,82	1.302,52	1.657,14	32 W (1940 lm)	1.191,60	1.546,22
	26 W (1580 lm)	materials	+134,45		+117,65		26 W (1580 lm)	+134,45	
	26 W (1580 lm)	phantom/ black phantom	+201,68		+176,47		26 W (1580 lm)	+201,68	
	32 W (2070 lm)	chrome/colors	1.260,50	1.615,13	1.379,83	1.734,45	32 W (2070 lm)	1.268,91	1.623,53
	26 W (1690 lm)	materials	+134,45		+117,65		26 W (1690 lm)	+134,45	
	26 W (1690 lm)	phantom/ black phantom	+201,68		+176,47		26 W (1690 lm)	+201,68	

E
uplight diffuser glass/
downlight lens 80° + soft edge glass

D
up-/downlight
lens 80° + soft edge glass

Ⓢ special length up to 1000 cm possible (extra charge per head: +142,86, non discountable)

control	features	Occhio air
	»up/down fading«, switching, dimming via »touchless control« (can be deactivated) and Occhio air (optional), alternatively dimmable via trailing-edge phase cut dimmer	Bluetooth control integrated in luminaire heads, features via Occhio air app or »air« controller (optional) controllable, no external dimming possible +82,35

options	light source	surfaces	head/base*	colors	materials/phantom
	2700 K or 3000 K, perfect color LED CRI 97		chrome shiny chrome matt chrome	glossy white matt white matt black matt gold	rose gold bronze phantom black phantom

*for pure: base always matt white
The surfaces rose gold, bronze, phantom and black phantom may differ slightly from other product lines.

further options	- further mounting accessories view page 118 - accessories for Occhio air from page 226	These and further options can be configured at Occhio Digital Order System (DOS)	further information	- technical data, information on control and mounting options view pages 119–120
------------------------	--	--	----------------------------	--

Sento sospeso

suspended luminaires



due



tre

fix
fix cable length adjustable during mounting
max. 350 cm

variable
variable continuous height adjustment
50–200 cm

fix
for surface-mounted
installation through-wiring
possible

variable

Ⓢ the luminaire heads are synced via an internal control wire

fix
for surface-mounted
installation through-wiring
possible

variable

Ⓢ the luminaire heads are synced via an internal control wire

versions



2 x 32 W (2 x 1940 lm) **chrome/colors** 3.186,55 3.895,80
2 x 26 W (2 x 1580 lm) shiny chrome

2 x 26 W (2 x 1580 lm) **materials** +235,29

2 x 26 W (2 x 1580 lm) **phantom/
black phantom** +352,94

3 x 32 W (3 x 1940 lm) 4.836,97 5.900,84
3 x 26 W (3 x 1580 lm)

3 x 26 W (3 x 1580 lm) +352,94

3 x 26 W (3 x 1580 lm) +529,41

E

uplight diffusor glass/
downlight lens 80° + soft edge glass



2 x 32 W (2 x 2070 lm) **chrome/colors** 3.341,18 4.050,42
2 x 26 W (2 x 1690 lm) shiny chrome

2 x 26 W (2 x 1690 lm) **materials** +235,29

2 x 26 W (2 x 1690 lm) **phantom/
black phantom** +352,94

3 x 32 W (3 x 2070 lm) 5.068,91 6.132,77
3 x 26 W (3 x 1690 lm)

3 x 26 W (3 x 1690 lm) +352,94

3 x 26 W (3 x 1690 lm) +529,41

D

up-/downlight
lens 80° + soft edge glass

Ⓢ special length up to 1000 cm possible (extra charge per head: +142,86, non discountable)

control

features

»up/down fading«, switching, dimming via
»touchless control« (deactivatable) and
Occhio air (optional), alternatively dimmable
via trailing-edge phase cut dimmer

Occhio air



Bluetooth control integrated in luminaire heads,
features via Occhio air app or »air« controller (optional)
controllable, no external dimming possible

+ 82,35

options

light source

2700 K or 3000 K, perfect color LED CRI 97

surfaces

head/canopy chrome

shiny chrome/matt white
matt chrome/matt white

colors

glossy white/matt white
matt white/matt white
matt black/matt white
matt gold/matt white

materials/phantom

rose gold/matt white
bronze/matt white
phantom/matt white
black phantom/matt white

The surfaces rose gold, bronze, phantom and black phantom may differ slightly from other product lines.

further options

- further mounting accessories view page 118
- accessories for Occhio air from page 226

These and further options can be configured at
Occhio Digital Order System (DOS)

further information

- technical data, information on control and mounting options view pages 119–120

Sento sospeso mounting accessories

sideways inlet (single- or double-sided) through-wiring set
for all surface-mounted versions (except due/tre),
H 7 mm, ø 107 mm (ø base 108 mm)

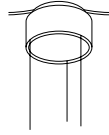

matt white

38,66

canopy with outlet on one or both sides
for all surface-mounted versions,
H 15 mm, ø 88 mm



shiny chrome
glossy white
matt chrome
matt white
matt black

55,46

cavity box
for mounting of flat luminaires
in hollow ceilings and -walls



3,36

Sento sospeso mounting options

head: ø 123 mm, H 72 mm

up
with integrated power supply for surface mounting,
through-wiring possible.

Ⓢ synchronization of multiple luminaires via
»air« sync possible (prerequisite all luminaires
with »air« and same type)



Occhio air optional

flat
with flat base for cavity box,
remote power supply,
installation depth: min. 30 mm, (min. 80 mm if the power
supply is installed through the luminaire's ceiling opening)

Ⓢ synchronization of multiple luminaires via
»air« sync possible (prerequisite all luminaires
with »air« and same type)



Occhio air optional

due/tre
ceiling canopy with integrated power supply for
surface mounting, through-wiring possible

dimensions of ceiling canopy
due: L 1020 x W 120 x H 40 mm
tre: L 1920 x W 120 x H 40 mm
distance between bodies: 90 cm

Ⓢ the luminaire heads are synced via
an internal control line



Occhio air optional

pure
with plastering element for flush ceiling-mounted
installation, remote power supply (optional),
installation depth: min. 30 mm, (min. 80 mm when
mounting power supply through luminaire opening)

Ⓢ synchronization of multiple luminaires via
»air« sync possible (prerequisite all luminaires
with »air« and same type)



Occhio air optional

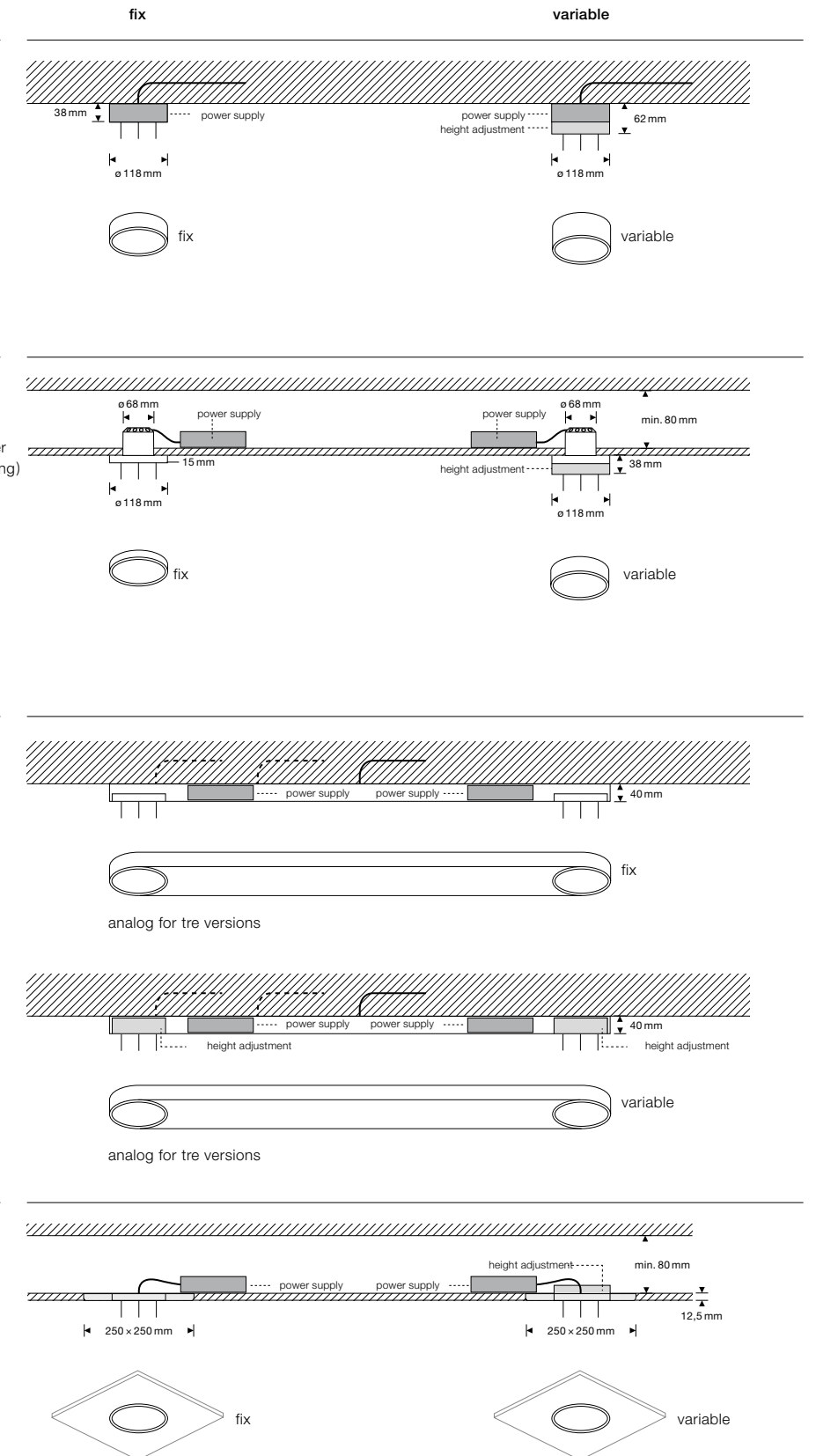

Sento sospeso technical data and control

version »touchless control«

connection	U	230 V AC
average service life	t	> 50.000 h
energy efficiency class	EEK	G

LED		perfect color
color temperature	T	2700 K, 3000 K
Color Rendering Index	CRI	Ra 97
recommended use		residential and public

power	P	perfect color	
luminous flux luminaire	φ	26 W	32 W
lighting effects E		1580 lm	1940 lm
lighting effects D		1690 lm	2070 lm

control

with Occhio power supply

The Occhio converter is perfectly matched to these requirements and can be dimmed by trailing-edge phase cut dimmer*. Can not be used in conjunction with »touchless control« or Occhio air.

*Occhio air
powered by
Casambi*

 **Occhio air**
control via Bluetooth – switching, dimming, »up/down fading«
of individual luminaires, groups and scenes.

touchless dim funktion Sento sospeso luminaire heads



SENSOR OFF

Luminaires can be dimmed via remote trailing-edge phase cut dimmers* or controlled via Occhio air (optional) (switching, dimming, »up/down fading«).

SENSOR DIM

Luminaires can be controlled via »touchless control« with simple gestures control function integrated in the head or via Occhio air (optional) (switching, dimming, »up/down fading«).

SENSOR STEP

This setting enables the up/down ratio and brightness to be preconfigured and saved. Additionally dimmable via trailing-edge phase cut dimmer*.

*compatible dimmers: occhio.com/dim

L series

Più

The power of innovation – the modular spotlight system for holistic lighting design.

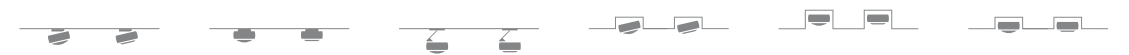

Più

ceiling spotlights



alto



alto v



R alto



R alto v

360° rotatable
for surface-mounted installation

swivel range 52°

non-swiveling

swivel range 52°

non-swiveling

versions



max. 26 W (1290 lm)

chrome/colors

563,03

394,96

materials

+67,23

phantom/black phantom

+100,84

C 80
80°/lens



max. 26 W (1030 lm)

chrome/colors

579,83

411,76

materials

+67,23

phantom/black phantom

+100,84

S 100
100°/lens
+ satinised glass



max. 26 W (1140 lm)

chrome/colors

579,83

411,76

materials

+67,23

phantom/black phantom

+100,84

S 80
80°/lens
+ soft edge glass



max. 26 W (1280 lm)

chrome/colors

596,64

428,57

materials

+67,23

phantom/black phantom

+100,84

S 40
40°/lens
+ soft edge glass + small lens medium

versions



max. 26 W (1400 lm)

chrome/colors

556,30

388,24

materials

+67,23

phantom/black phantom

+100,84

C 80
80°/cone glass
+ small lens medium



max. 26 W (1210 lm)

chrome/colors

573,11

405,04

materials

+67,23

phantom/black phantom

+100,84

S 100
100°/cone glass
+ soft edge glass + small lens flat



max. 26 W (1250 lm)

chrome/colors

573,11

405,04

materials

+67,23

phantom/black phantom

+100,84

S 80
80°/cone glass
+ soft edge glass + small lens medium



max. 26 W (1220 lm)

chrome/colors

581,51

413,45

materials

+67,23

phantom/black phantom

+100,84

S 40
40°/cone glass
+ Fresnel lens + small lens medium

control

features

 **230V light engine 26 W (switchable 13/18/26 W)**
dimmable via trailing-edge phase cut dimmer

Occhio air module

Bluetooth dimming module for mounting in hollow ceiling or switch box (can be put in doppio base), for max. 4 spotlights

82,35

Occhio air adapter

adapter ring incl. »air« module, mounting under luminaire (not for doppio), matt black or matt white

110,92

inserts

 filter red 33,61
 filter green
 filter blue
 filter yellow
 filter magenta
(max. 18 W)



options

light source

2700 K or 3000 K, perfect color CRI97

surfaces





head/base chrome

shiny chrome 
glossy white/shiny chrome 
matt chrome 

colors

matt white 
matt black 
matt gold/matt white 
matt gold/matt black 

materials/phantom/black phantom

rose gold/matt black 
bronze/matt black 
phantom/matt black 
black phantom/matt black 

The surfaces rose gold, bronze, phantom and black phantom may differ slightly from other product lines.

further options

- further lighting effects view page 148
- further mounting accessories view page 140
- further accessories for Occhio air from page 226

These and further options can be configured at **Occhio Digital Order System (DOS)**

further information

- technical data and information on mounting options view pages 142-149

Più

ceiling spotlights



alto doppio



R alto doppio

swivel range 52°
360° rotatable
for surface-mounted installation

versions

 2 x 26 W (1290 lm)	chrome/colors	1.121,01
	materials	+134,45
	phantom/black phantom	+201,68

C 80
80°/lens

 2 x 26 W (1030 lm)	chrome/colors	1.154,62
	materials	+134,45
	phantom/black phantom	+201,68

S 100
100°/lens
+ satinised glass

 2 x 26 W (1140 lm)	chrome/colors	1.154,62
	materials	+134,45
	phantom/black phantom	+201,68

S 80
80°/lens
+ soft edge glass

 2 x 26 W (1280 lm)	chrome/colors	1.188,24
	materials	+134,45
	phantom/black phantom	+201,68

S 40
40°/lens
+ soft edge glass + small lens medium

versions

 2 x 26 W (1400 lm)	chrome/colors	1.107,56
	materials	+134,45
	phantom/black phantom	+201,68

C 80
80°/cone glass
+ small lens medium

 2 x 26 W (1210 lm)	chrome/colors	1.141,18
	materials	+134,45
	phantom/black phantom	+201,68

S 100
100°/cone glass
+ soft edge glass + small lens flat

 2 x 26 W (1250 lm)	chrome/colors	1.141,18
	materials	+134,45
	phantom/black phantom	+201,68

S 80
80°/cone glass
+ soft edge glass + small lens medium

 2 x 26 W (1220 lm)	chrome/colors	1.157,98
	materials	+134,45
	phantom/black phantom	+201,68

S 40
40°/cone glass
+ Fresnel lens + small lens medium

control

features





 **230V light engine 26 W**
(switchable 13/18/26 W)
dimmable via trailing-edge
phase cut dimmer

Occhio air module

Bluetooth dimming module for
mounting in hollow ceiling or switch
box (can be put in doppio base),
for max. 4 spotlights

82,35

inserts

	filter red	33,61
	filter green	
	filter blue	
	filter yellow	
	filter magenta	
(max. 18 W)		

options

light source

2700 K or 3000 K, perfect color CRI97

surfaces

head/base chrome

shiny chrome/matt white
matt chrome/matt white
glossy white/shiny chrome/
matt white



colors

matt white
matt black
matt gold/matt white
matt gold/matt black



materials/phantom/black phantom

rose gold/matt black
bronze/matt black
phantom/matt black
black phantom/matt black



The surfaces rose gold, bronze, phantom and black phantom may differ slightly from other product lines.

further options

- further lighting effects view page 148
- further mounting accessories view page 140
- further accessories for Occhio air from page 226

These and further options can be configured at
Occhio Digital Order System (DOS)

further information

- technical data and information on mounting options view pages 142-149

Più

ceiling spotlights



alto 3d



alto 3d doppio



R alto 3d



R alto 3d doppio

swivel range 90°
360° rotatable
for surface-mounted installation
through-wiring possible

versions*

	max. 26 W (1290 lm)	chrome/colors	616,81	1.228,57
		materials	+67,23	+134,45
		phantom/black phantom	+100,84	+201,68

C 80
80°/lens

	max. 26 W (1030 lm)	chrome/colors	633,61	1.262,18
		materials	+67,23	+134,45
		phantom/black phantom	+100,84	+201,68

S 100
100°/lens
+ satinised glass

	max. 26 W (1140 lm)	chrome/colors	633,61	1.262,18
		materials	+67,23	+134,45
		phantom/black phantom	+100,84	+201,68

S 80
80°/lens
+ soft edge glass

	max. 26 W (1280 lm)	chrome/colors	650,42	1.295,80
		materials	+67,23	+134,45
		phantom/black phantom	+100,84	+201,68

S 40
40°/lens
+ soft edge glass + small lens medium

*versions doppio: 2 × 26 W

versions*

	max. 26 W (1400 lm)	chrome/colors	610,08	1.215,13
		materials	+67,23	+134,45
		phantom/black phantom	+100,84	+201,68

C 80
80°/cone glass
+ small lens medium

	max. 26 W (1210 lm)	chrome/colors	626,89	1.248,74
		materials	+67,23	+134,45
		phantom/black phantom	+100,84	+201,68

S 100
100°/cone glass
+ soft edge glass + small lens flat

	max. 26 W (1250 lm)	chrome/colors	626,89	1.248,74
		materials	+67,23	+134,45
		phantom/black phantom	+100,84	+201,68

S 80
80°/cone glass
+ soft edge glass + small lens medium

	max. 26 W (1220 lm)	chrome/colors	635,29	1.265,55
		materials	+67,23	+134,45
		phantom/black phantom	+100,84	+201,68

S 40
40°/cone glass
+ Fresnel lens + small lens medium

*versions doppio: 2 × 26 W

control

features

 **230V light engine 26 W**
(switchable 13/18/26 W)
dimmable via trailing-edge
phase cut dimmer

Occhio air module



Bluetooth dimming module for
mounting in hollow ceiling or switch
box (can be put in doppio base),
for max. 4 spotlights

82,35





Occhio air adapter



adapter ring incl. »air« module,
mounting under luminaire
(not for doppio),
matt black or matt white

110,92

inserts

	filter red	33,61
	filter green	
	filter blue	
	filter yellow	
	filter magenta	
(max. 18 W)		

options

light source

2700 K or 3000 K, perfect color CRI97

surfaces

head/body/base

chrome

shiny chrome*
matt chrome*
glossy white/shiny chrome/
glossy white*



colors

matt white
matt black
matt gold/matt white
matt gold/matt black



materials/phantom/black phantom

rose gold/matt black
bronze/matt black
phantom/matt black
black phantom/matt black



*for doppio: base matt white

The surfaces rose gold, bronze, phantom and black phantom may differ slightly from other product lines.

further options

- further lighting effects view page 148
- further mounting accessories view page 140
- further accessories for Occhio air from page 226

These and further options can be configured at
Occhio Digital Order System (DOS)

further information

- technical data and information on mounting options view pages 142-149

Più

track spotlights



alto track



alto 3d track



R alto track



R alto 3d track

360° rotatable
with in-trac adapter, for Eutrac, Erco
and Zumtobel 3-phase tracks

swivel range 52°

swivel range 90°

swivel range 52°

swivel range 90°

versions



max. 26 W (1290 lm)

chrome/colors	522,69
materials	+67,23
phantom/black phantom	+100,84

C 80
80°/lens



max. 26 W (1030 lm)

chrome/colors	539,50
materials	+67,23
phantom/black phantom	+100,84

S 100
100°/lens
+ satinised glass



max. 26 W (1140 lm)

chrome/colors	539,50
materials	+67,23
phantom/black phantom	+100,84

S 80
80°/lens
+ soft edge glass



max. 26 W (1280 lm)

chrome/colors	556,30
materials	+67,23
phantom/black phantom	+100,84

S 40
40°/lens
+ soft edge glass + small lens medium

versions



max. 26 W (1400 lm)

chrome/colors	515,97
materials	+67,23
phantom/black phantom	+100,84

C 80
80°/cone glass
+ small lens medium



max. 26 W (1210 lm)

chrome/colors	532,77
materials	+67,23
phantom/black phantom	+100,84

S 100
100°/cone glass
+ soft edge glass + small lens flat



max. 26 W (1250 lm)

chrome/colors	532,77
materials	+67,23
phantom/black phantom	+100,84

S 80
80°/cone glass
+ soft edge glass + small lens medium



max. 26 W (1220 lm)

chrome/colors	541,18
materials	+67,23
phantom/black phantom	+100,84

S 40
40°/cone glass
+ Fresnel lens + small lens medium

control

features



230V light engine 26 W
(switchable 13/18/26 W)
dimmable via trailing-edge
phase cut dimmer

inserts

	filter red	33,61
	filter green	
	filter blue	
	filter yellow	
	filter magenta	
(max. 18 W)		

options

light source

2700 K or 3000 K, perfect color CRI97

surfaces

head/body* + adapter

chrome

shiny chrome/matt white
matt chrome
glossy white/shiny chrome/
matt white



colors

matt white
matt black
matt gold/matt white
matt gold/matt black



materials/phantom/black phantom

rose gold/matt black
bronze/matt black
phantom/matt black
black phantom/matt black



*body only for alto 3d

The surfaces rose gold, bronze, phantom and black phantom may differ slightly from other product lines.

further options

- further lighting effects view page 148
- accessories for Occhio air from page 226

These and further options can be configured at
Occhio Digital Order System (DOS)

further information

- technical data and information on mounting options view pages 142-149

Più spotlights

recessed spotlights



piano edge piano cover round piano cover square



R piano edge R piano cover round R piano cover square

360° rotatable, swivel range 30°

for recessed mounting with filigree ceiling edge

for recessed mounting installation with cover square

for recessed mounting with filigree ceiling edge

for recessed mounting installation with cover round

for recessed mounting installation with cover square

versions

	max. 26 W (1400 lm)	chrome/colors	352,94	452,10	452,10
	materials		+67,23	+84,03	
	phantom/black phantom		+100,84	+126,05	

C 80
80°/lens

versions

	max. 26 W (1400 lm)	chrome/colors	346,22	445,38	445,38
	materials		+67,23	+84,03	
	phantom/black phantom		+100,84	+126,05	

C 80
80°/cone glass
+ small lens medium

	max. 26 W (1030 lm)	chrome/colors	369,75	468,91	468,91
	materials		+67,23	+84,03	
	phantom/black phantom		+100,84	+126,05	

S 100
100°/lens
+ satinised glass

	max. 26 W (1210 lm)	chrome/colors	363,03	462,18	462,18
	materials		+67,23	+84,03	
	phantom/black phantom		+100,84	+126,05	

S 100
100°/lens
+ satinised glass

	max. 26 W (1140 lm)	chrome/colors	369,75	468,91	468,91
	materials		+67,23	+84,03	
	phantom/black phantom		+100,84	+126,05	

S 80
80°/lens
+ soft edge glass

	max. 26 W (1250 lm)	chrome/colors	363,03	462,18	462,18
	materials		+67,23	+84,03	
	phantom/black phantom		+100,84	+126,05	

S 80
80°/lens
+ soft edge glass

	max. 26 W (1280 lm)	chrome/colors	386,55	485,71	485,71
	materials		+67,23	+84,03	
	phantom/black phantom		+100,84	+126,05	

S 40
40°/lens
+ soft edge glass + small lens medium

	max. 26 W (1220 lm)	chrome/colors	371,43	470,59	470,59
	materials		+67,23	+84,03	
	phantom/black phantom		+100,84	+126,05	

S 40
40°/lens
+ soft edge glass + small lens medium

can also be configured as pro version
excl. power supply at Digital Order System (DOS)

can also be configured as pro version
excl. power supply at Digital Order System (DOS)

control

features

230V light engine 26 W (switchable 13/18/26 W)
dimmable via trailing-edge phase cut dimmer

Occhio air module

Bluetooth dimming module for mounting in hollow ceiling or switch box for max. 4 spotlights

82,35

inserts

	filter red	33,61
	filter green	
	filter blue	
	filter yellow	
	filter magenta	
(max. 18 W)		

options

light source

2700 K or 3000 K, perfect color CRI97
pro version also available in 4000 K, perfect color CRI97

surfaces

head*/cover

chrome
shiny chrome
matt chrome

colors

matt white
matt black
matt gold

materials/phantom/black phantom

rose gold
bronze
phantom
black phantom

tube/edging

matt white
matt black

*no cover for edge version, ceiling edge always in color of the tube
The surfaces rose gold, bronze, phantom and black phantom may differ slightly from other product lines.

further options

- further lighting effects view page 148
- accessories for Occhio air from page 226

These and further options can be configured at
Occhio Digital Order System (DOS)

further information

- technical data and information on mounting options view pages 142-149

Più spotlights

recessed spotlights



piano in edge piano in cover round piano in cover square



R piano in edge R piano in cover round R piano in cover square

360° rotatable, swivel range 20°

for recessed mounting with filigree ceiling edge

for recessed mounting installation with cover round

for recessed mounting installation with cover square

for recessed mounting with filigree ceiling edge

for recessed mounting installation with cover round

for recessed mounting installation with cover square

versions



max. 26 W (1640 lm)

chrome/colors	389,92	489,08	489,08
materials	+67,23	+84,03	
phantom/black phantom	+100,84	+126,05	

C 80
80°/lens



max. 26 W (1030 lm)

chrome/colors	406,72	505,88	505,88
materials	+67,23	+84,03	
phantom/black phantom	+100,84	+126,05	

S 100
100°/lens
+ satinised glass



max. 26 W (1140 lm)

chrome/colors	406,72	505,88	505,88
materials	+67,23	+84,03	
phantom/black phantom	+100,84	+126,05	

S 80
80°/lens
+ soft edge glass



max. 26 W (1280 lm)

chrome/colors	423,53	522,69	522,69
materials	+67,23	+84,03	
phantom/black phantom	+100,84	+126,05	

S 40
40°/lens
+ soft edge glass + small lens medium

can also be configured as pro version
excl. power supply at Digital Order System (DOS)

versions



max. 26 W (1400 lm)

chrome/colors	383,19	482,35	482,35
materials	+67,23	+84,03	
phantom/black phantom	+100,84	+126,05	

C 80
80°/cone glass
+ small lens medium



max. 26 W (1210 lm)

chrome/colors	400,00	499,16	499,16
materials	+67,23	+84,03	
phantom/black phantom	+100,84	+126,05	

S 100
100°/lens
+ satinised glass



max. 26 W (1250 lm)

chrome/colors	400,00	499,16	499,16
materials	+67,23	+84,03	
phantom/black phantom	+100,84	+126,05	

S 80
80°/lens
+ soft edge glass



max. 26 W (1220 lm)

chrome/colors	408,40	507,56	507,56
materials	+67,23	+84,03	
phantom/black phantom	+100,84	+126,05	

S 40
40°/lens
+ soft edge glass + small lens medium

can also be configured as pro version
excl. power supply at Digital Order System (DOS)

control

features

230V light engine 26 W (switchable 13/18/26 W)
dimmable via trailing-edge phase cut dimmer

Occhio air module

Bluetooth dimming module for mounting in hollow ceiling or switch box for max. 4 spotlights

82,35

inserts

filter red	33,61
filter green	
filter blue	
filter yellow	
filter magenta	
(max. 18 W)	

options

light source

2700 K or 3000 K, perfect color CRI97
pro version also available in 4000 K, perfect color CRI97

surfaces

head*/cover

chrome
shiny chrome
matt chrome

colors

matt white
matt black
matt gold

materials/phantom/black phantom

rose gold
bronze
phantom
black phantom

tube/edging

matt white
matt black

*no cover for edge version, ceiling edge always in color of the tube
The surfaces rose gold, bronze, phantom and black phantom may differ slightly from other product lines.

further options

- further lighting effects view page 148
- accessories for Occhio air from page 226

These and further options can be configured at
Occhio Digital Order System (DOS)

further information

- technical data and information on mounting options view pages 142-149

Più spotlights

recessed spotlights



piano v
edge

piano v
cover round

piano v
cover square



R piano v
edge

R piano v
cover round

R piano v
cover square

non-rotatable,
non-swiveling

for recessed mounting
with filigree ceiling edge

for recessed mounting
installation with cover
round

for recessed mounting
installation with cover
square

for recessed mounting
with filigree ceiling edge

for recessed mounting
installation with cover
round

for recessed mounting
installation with cover
square

versions



max. 26 W (1640 lm)

chrome/colors

278,99

359,66

359,66

materials

—

+16,81

phantom/black phantom

—

+25,21

C 80

80°/lens

versions



max. 26 W (1400 lm)

chrome/colors

272,27

352,94

352,94

materials

272,27

+16,81

phantom/black phantom

272,27

+25,21

C 80

80°/cone glass
+ small lens medium



max. 26 W (1030 lm)

chrome/colors

295,80

376,47

376,47

materials

—

+16,81

phantom/black phantom

—

+25,21

S 100

100°/lens
+ satinised glass



max. 26 W (1210 lm)

chrome/colors

289,08

369,75

369,75

materials

289,08

+16,81

phantom/black phantom

289,08

+25,21

S 100

100°/lens
+ satinised glass



max. 26 W (1140 lm)

chrome/colors

295,80

376,47

376,47

materials

—

+16,81

phantom/black phantom

—

+25,21

S 80

80°/lens
+ soft edge glass



max. 26 W (1250 lm)

chrome/colors

289,08

369,75

369,75

materials

289,08

+16,81

phantom/black phantom

289,08

+25,21

S 80

80°/lens
+ soft edge glass



max. 26 W (1280 lm)

chrome/colors

312,61

393,28

393,28

materials

—

+16,81

phantom/black phantom

—

+25,21

S 40

40°/lens
+ soft edge glass + small lens medium



max. 26 W (1220 lm)

chrome/colors

297,48

378,15

378,15

materials

297,48

+16,81

phantom/black phantom

297,48

+25,21

S 40

40°/lens
+ soft edge glass + small lens medium

can also be configured as pro version
excl. power supply at Digital Order System (DOS)

can also be configured as pro version
excl. power supply at Digital Order System (DOS)

control

features



230V light engine 26 W
(switchable 13/18/26 W)
dimmable via trailing-edge
phase cut dimmer

Occhio air module



Bluetooth dimming module for
mounting in hollow ceiling or switch
box for max. 4 spotlights

82,35

inserts

- filter red
- filter green
- filter blue
- filter yellow
- filter magenta

33,61

(max. 18 W)

options

light source

2700 K or 3000 K, perfect color CRI97
pro version also available in 4000 K, perfect color CRI97

surfaces

head*/cover

chrome

shiny chrome

matt chrome

colors

matt white

matt black

matt gold

materials/phantom/black phantom

rose gold

bronze

phantom

black phantom

tube/edging

matt white

matt black

*head and tube of piano v only available in matt white and matt black

The surfaces rose gold, bronze, phantom and black phantom may differ slightly from other product lines.

further options

- further lighting effects view page 148
- accessories for Occhio air from page 226

These and further options can be configured at
Occhio Digital Order System (DOS)

further information

- technical data and information on mounting options view pages 142–149

Più piano pure

recessed spotlights



piano pure



piano in pure



R piano pure



R piano in pure

360° rotatable
for recessed mounting installation
seamless mounting incl. mounting board

swivel range 30°

swivel range 30°

swivel range 30°

swivel range 20°

versions



max. 26 W (1810 lm)

chrome/colors	504,20
materials	+67,23
phantom/black phantom	+100,84

541,18

C 80
80°/lens
+ small lens medium



max. 26 W (1210 lm)

chrome/colors	521,01
materials	+67,23
phantom/black phantom	+100,84

557,98

S 100
100°/lens
+ satinised glass



max. 26 W (1250 lm)

chrome/colors	521,01
materials	+67,23
phantom/black phantom	+100,84

557,98

S 80
80°/lens
+ soft edge glass



max. 26 W (1220 lm)

chrome/colors	537,82
materials	+67,23
phantom/black phantom	+100,84

574,79

S 40
40°/lens
+ soft edge glass + small lens medium

can also be configured as pro version
excl. power supply at Digital Order System (DOS)

versions



max. 26 W (1400 lm)

chrome/colors	497,48
materials	+67,23
phantom/black phantom	+100,84

534,45

C 80
80°/cone glass
+ small lens medium



max. 26 W (1210 lm)

chrome/colors	514,29
materials	+67,23
phantom/black phantom	+100,84

551,26

S 100
100°/cone glass
+ soft edge glass + small lens flat



max. 26 W (1250 lm)

chrome/colors	514,29
materials	+67,23
phantom/black phantom	+100,84

551,26

S 80
80°/cone glass
+ soft edge glass + small lens medium



max. 26 W (1220 lm)

chrome/colors	522,69
materials	+67,23
phantom/black phantom	+100,84

559,66

S 40
40°/cone glass
+ Fresnel lens + small lens medium

can also be configured as pro version
excl. power supply at Digital Order System (DOS)

control

features

230V light engine 26 W
(switchable 13/18/26 W)
dimmable via trailing-edge
phase cut dimmer

Occhio air module



Bluetooth dimming module for
mounting in hollow ceiling or switch
box for max. 4 spotlights

82,35

inserts

filter red	33,61
filter green	
filter blue	
filter yellow	
filter magenta	
(max. 18 W)	

options

light source

2700 K or 3000 K, perfect color CRI97
pro version also available in 4000 K, perfect color CRI97

surfaces

head

chrome	
shiny chrome	
matt chrome	

colors

matt white	
matt black	
matt gold	

materials/phantom/black phantom

rose gold	
bronze	
phantom	
black phantom	

tube/edging

matt white	
matt black	

The surfaces rose gold, bronze, phantom and black phantom may differ slightly from other product lines.

further options







- further lighting effects view page 148
- accessories for Occhio air from page 226

These and further options can be configured at
Occhio Digital Order System (DOS)

further information

- technical data and information on mounting options view pages 142-149

Più mounting accessories

sideways inlet (single- or double- sided) through-wiring set (for alto) for all surface-mounted versions H 7 mm, ø 76 mm (ø base 88 mm)		matt white	28,57
canopy with outlet on one or both sides for all surface-mounted versions H 15 mm, ø 88 mm		shiny chrome glossy white matt chrome matt white matt black	55,46
cavity box for mounting of flat luminaires in hollow ceilings and -walls			3,36
inserts (color filter max. 18 W)	filter red filter green filter blue filter yellow filter magenta		33,61
	satinised glass soft edge glass Fresnel-lens		16,81 16,81 25,21
	small lens flat small lens medium small lens high		23,53
Occhio air module Bluetooth 4.0 dim module for phase-cut dimmable spotlights and power supply units, mounting in cavity or switch box, max. 4 x 32 W (with Occhio converter, other converters max. 52 W), L 40 mm x W 36 mm x H 14 mm			82,35
Occhio air adapter			
for Più alto adapter ring incl. »air« module, mounting under surface-mounted spacing box, ø 83 mm, H 14 mm		matt white matt black	110,92
for Più alto v adapter ring incl. »air« module, mounting under surface-mounted spacing box, ø 83 mm, H 14 mm		matt white matt black	110,92
for Più alto 3d adapter ring incl. »air« module, mounting under surface-mounted spacing box, ø 88 mm, H 14 mm		matt white matt black	110,92

Can be configured at **Occhio Digital Order System (DOS)**

Più alto mounting options

alto
head H42 mm, ø123 mm
base H20 mm, ø83 mm



52° swivel range
360° rotatable

solid ceiling with
230 V mains connection

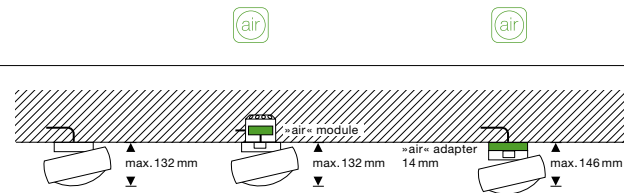

alto v
head H42 mm, ø123 mm
base H20 mm, ø83 mm



non swiveling

solid ceiling with
230 V mains connection

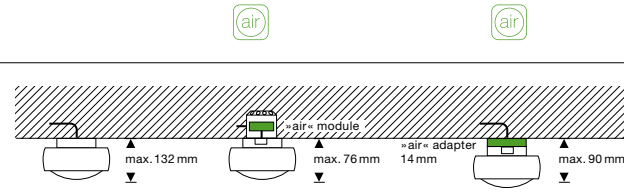

alto doppio
head H42 mm, ø123 mm
base L225 mm x W45 mm x H21,5 mm

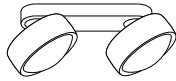

52° swivel range
360° rotatable

solid ceiling with
230 V mains connection,
through-wiring possible

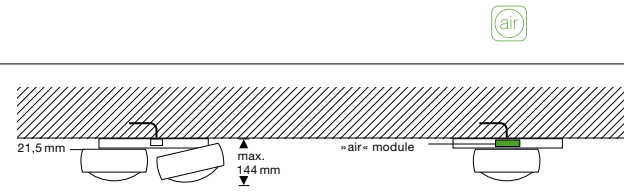

alto track
head H42 mm, ø123 mm
with in-trac adapter

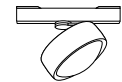

52° swivel range
360° rotatable

3-phase track, only for
Eutrac, Erco and Zumtobel
tracks*

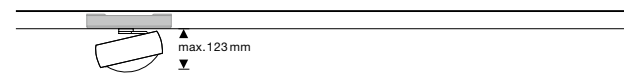

Più alto 3d mounting options

alto 3d VOLT
head H42 mm, ø123 mm
base H16 mm, ø88 mm



90° swivel range
360° rotatable

solid ceiling with
230 V mains connection,
through-wiring possible

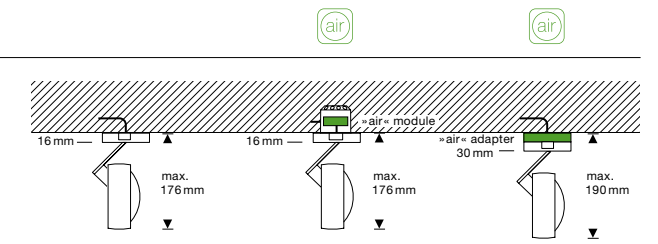

alto 3d doppio VOLT
head H42 mm, ø123 mm
base L225 mm x W45 mm x H21,5 mm

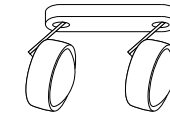

90° swivel range
360° rotatable

solid ceiling with
230 V mains connection,
through-wiring possible

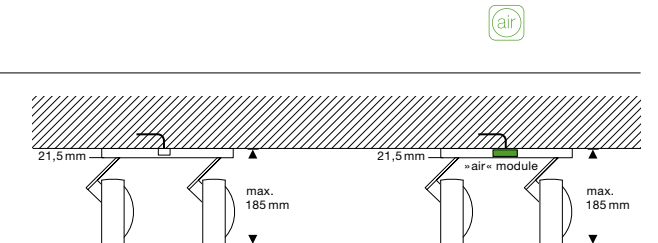

alto 3d track VOLT
head H42 mm, ø123 mm
with in-trac adapter

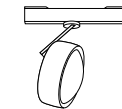

90° swivel range
360° rotatable

3-phase track, only for
Eutrac, Erco and Zumtobel
tracks*

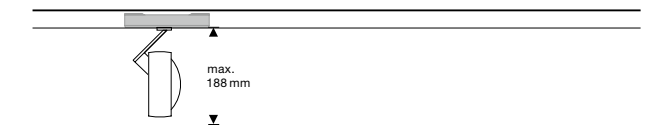

*adapter for 1 phase tracks can be configured optionally

Più piano mounting options

piano edge
head H38 mm, ø125 mm



 optional with Occhio air

edge mounting tube

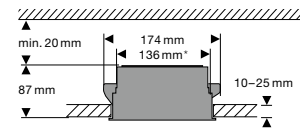

hollow ceiling

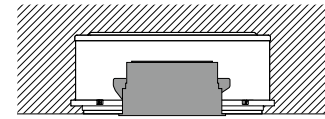

concrete ceiling
(Kaiser HaloX 250 with mineral-fibre board)



ceiling edge

piano cover
head H38 mm, ø125 mm

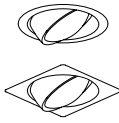

20° swivel range
360° rotatable

 optional with Occhio air

mounting tube with cover

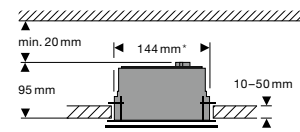

hollow ceiling

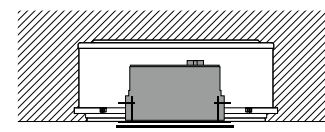

concrete ceiling
(Kaiser HaloX 250 with mineral-fibre board)

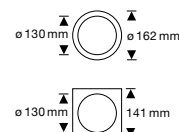

cover

Più piano in mounting options

piano in edge
head H38 mm, ø125 mm



 optional with Occhio air

edge mounting tube

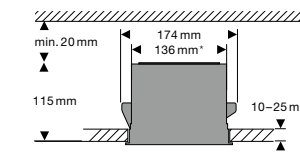

hollow ceiling

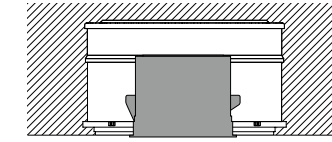

concrete ceiling
(Kaiser HaloX 250 with 50 mm intermediate frame and mineral-fibre board)



ceiling edge

piano in cover
head H38 mm, ø125 mm

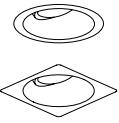

30° swivel range
360° rotatable

 optional with Occhio air

mounting tube in with cover

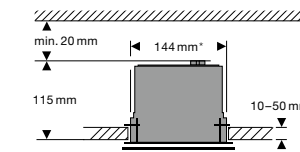

hollow ceiling

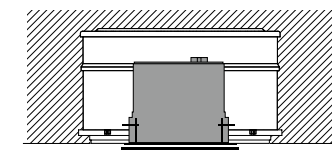

concrete ceiling
(Kaiser HaloX 250 with 50 mm intermediate frame and mineral-fibre board)

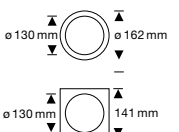

cover

piano pure
head H38 mm, ø125 mm

as pro version (=constant current=)
excl. remote power supply available

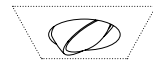

30° swivel range
360° rotatable

 optional with Occhio air

mounting board for seamless mounting

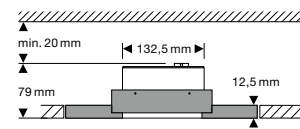

hollow ceiling
(fibre cement board with holding ring)

flush-mount ring for seamless mounting

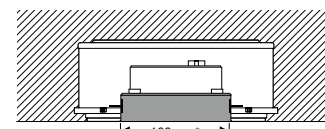

concrete ceiling plastered, no fair-faced concrete
(Kaiser HaloX 250 with mineral-fibre board)

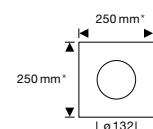

holding ring for panel for seamless mounting

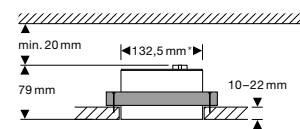

hollow ceiling
(mounting from back)

piano in pure
head H38 mm, ø125 mm

as pro version (=constant current=)
excl. remote power supply available

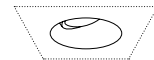

20° swivel range
360° rotatable

 optional with Occhio air

mounting board for seamless mounting

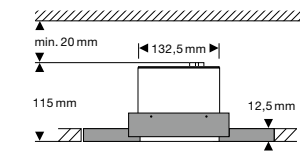

hollow ceiling
(fibre cement board with holding ring)

flush-mount ring for seamless mounting

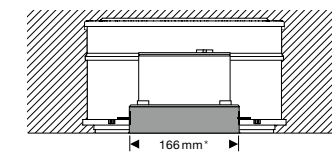

concrete ceiling plastered, no fair-faced concrete
(Kaiser HaloX 250 with 50 mm intermediate frame and mineral-fibre board)

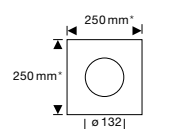

holding ring for panel for seamless mounting

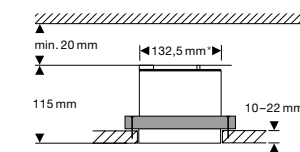

hollow ceiling
(mounting from back)

*cut-out dimension

Più piano v mounting options

piano v edge
head H38 mm, ø 125 mm



non swiveling



optional with Occhio air

edge mounting tube

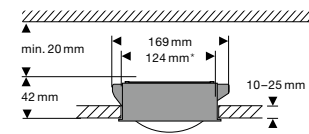

hollow ceiling

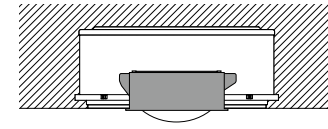

concrete ceiling
(Kaiser HaloX 250 with mineral-fibre board)



ceiling edge

piano v cover
head H38 mm, ø 125 mm

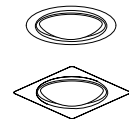

non swiveling



optional with Occhio air

mounting tube with cover

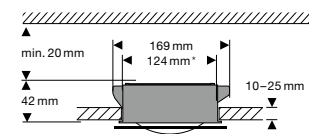

hollow ceiling

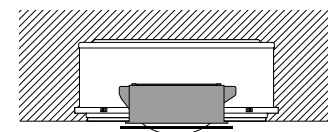



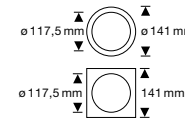





concrete ceiling
(Kaiser HaloX 250 with mineral-fibre board)



cover

*cut-out dimension

Più lighting effects (can be configured)

head	lens	R-version
diffus  B		diffus/cone glass + satinised glass + small lens flat
contour  C100		100°/cone glass + small lens flat
 C80	80°/lens	80°/cone glass + small lens medium
soft  S100	100°/lens + satinised glass	100°/cone glass + soft edge glass + small lens flat
 S80	80°/lens + soft edge glass	80°/cone glass + soft edge glass + small lens medium
 S60	60°/lens + soft edge glass + small lens flat	60°/cone glass + soft edge glass + small lens high
 S40	40°/lens + soft edge glass + small lens medium	40°/cone glass + Fresnel-lens + small lens medium
 S30	30°/lens + Fresnel-lens + small lens medium	30°/cone glass + Fresnel-lens + small lens high

Più luminaires with these lighting effects are configurable at **Occhio Digital Order System (DOS)**

Più technical data and control



Occhio VOLT light engine

connection	U	230 V AC/50 Hz
average service life	t	> 40.000 h
energy-efficiency class	EEK	G

LED		perfect color
color temperature	T	2700 K, 3000 K
Color Rendering Index	CRI	Ra 97
recommended use		residential and public

power	luminous flux luminaire	P φ	perfect color		
			26 W	18 W	13 W
Più	C 80		1290 lm	970 lm	730 lm
	S 100		1030 lm	780 lm	580 lm
	S 80		1140 lm	860 lm	640 lm
	S 60		1240 lm	930 lm	700 lm
	S 40		1280 lm	960 lm	720 lm
	S 30		1270 lm	950 lm	710 lm
Più R	B		1200 lm	900 lm	680 lm
	C 100		1340 lm	1000 lm	750 lm
	C 80		1400 lm	1050 lm	790 lm
	S 100		1210 lm	910 lm	680 lm
	S 80		1250 lm	940 lm	710 lm
	S 60		1220 lm	920 lm	690 lm
	S 30		1250 lm	940 lm	700 lm

control

Occhio air
powered by
Casambi

Più VOLT luminaires dimmable via trailing-edge phase cut dimmer*.

 **Occhio air**
control via Bluetooth – switching, dimming of individual luminaires, groups and scenes.

*compatible dimmers: occhio.com/dim

M series

io

The io luminaire series is synonymous with joy: joy in the playful use of light. Joy in the individual design options of the luminaire and the lighting effects. Joy in the perfect synthesis of form and function.

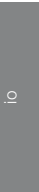
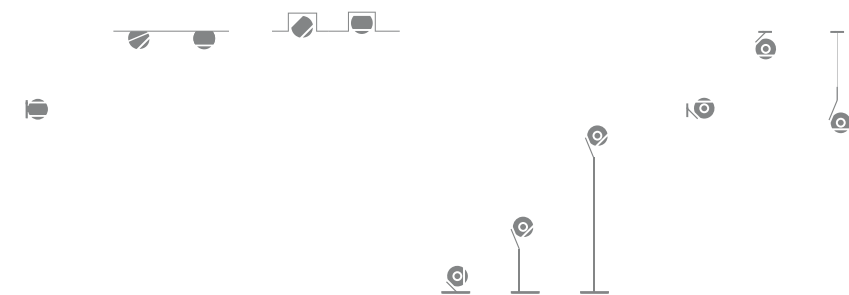

io spotlights
wall luminaires



verticale

for surface mounting
through-wiring possible

360° rotatable

version

	18 W (1020lm) 13 W (750lm)	chrome/colors shiny chrome	462,18
	13 W (750lm)	materials	+67,23
	13 W (750lm)	phantom/black phantom	+100,84

D
lens/lens
80°/80°
incl. soft edge glass

control

features

230 V light engine
dimnable via trailing-edge phase cut dimmer

Occhio air module

Bluetooth dimmer module,
mounting in hollow ceiling or
switch box, for max. 4 spotlights
82,35

Occhio air adapter

adapter ring incl. »air« module,
mounting under luminaire
110,92

inserts

	satinised glass, light cone with soft contour approx. 100°	13,45
	Fresnel lens, light cone with soft contour approx. 60°	28,57

options

light source

2700 K or 3000 K, perfect color CRI97

surfaces

head/base

chrome
shiny chrome

colors
matt white
matt black
matt gold/matt white
matt gold/matt black

materials/phantom/black phantom
rose gold/matt black
bronze/matt black
phantom/matt black
black phantom/matt black

The surfaces rose gold, bronze, phantom and black phantom may differ slightly from other product lines.

further options
- further mounting accessories view page 160
- accessories for Occhio air from page 226

These and further options can be configured at
Occhio Digital Order System (DOS)

further information
- technical data and information on mounting options view pages 161–164

io spotlights
ceiling spotlights



giro

giro doppio

alto v

for surface mounting
through-wiring possible

360° rotatable
swivel range 45°

360° rotatable
swivel range 45°

non-swiveling

version*



13W (650lm)

chrome/colors

371,43

784,87

302,52

materials

+67,23

+134,45

+67,23

phantom/black phantom

+100,84

+201,68

+100,84

C

lens 80°
incl. soft edge glass

*doppio versions: **2x13W** (2 x 490lm)

control

features



230V light engine
dimmable via trailing-edge phase cut dimmer

Occhio air module



Bluetooth dimmer module,
mounting in hollow ceiling or
switch box, for max. 4 spotlights
82,35

Occhio air adapter (incl. »air« module)

io giro/alto v
110,92



io giro doppio
110,92



inserts

— satinised glass, light cone
with soft contour approx. 100°

13,45

— Fresnel lens, light cone
with soft contour approx. 60°

28,57

options

light source

2700K or 3000K, perfect color CRI97

surfaces

head/base*

chrome

shiny chrome/matt white



colors

matt white
matt black
matt gold/matt white
matt gold/matt black



materials/phantom/black phantom

rose gold/matt black
bronze/matt black
phantom/matt black
black phantom/matt black



*only for doppio

The surfaces rose gold, bronze, phantom and black phantom may differ slightly from other product lines.

further options

- further mounting accessories view page 160
- accessories for Occhio air from page 226

These and further options can be configured at
Occhio Digital Order System (DOS)

further information

- technical data and information on mounting options view pages 161–164

io spotlights
recessed spotlights



piano edge piano cover round piano cover square

piano v edge piano v cover round piano v cover square

360° rotatable, swivel range 45°
incl. driver (trailing-edge phase cut dimmable)

for recessed mounting
with filigree ceiling edge

for recessed mounting
installation with cover round

for recessed mounting
installation with cover square

non-swivelling
incl. driver (trailing-edge
phase cut dimmable)

non-rotatable,
for recessed mounting
with filigree ceiling edge

for recessed mounting
installation with cover round

for recessed mounting
installation with cover square

version



13W (1010lm)

chrome/colors

299,16

379,83

379,83

226,89

262,18

262,18

materials

+67,23

+84,03

+67,23

+84,03

phantom/black phantom

+100,84

+126,05

+100,84

+126,05

C

lens 80°
incl. soft edge glass

can also be configured as pro version
excl. power supply at Digital Order System (DOS)

can also be configured as pro version
excl. power supply at Digital Order System (DOS)

control

features

»cc« version (constant current)
incl. remote power supply

Occhio air module

Bluetooth dimmer module,
mounting in hollow ceiling or
switch box, for max. 4 spotlights
82,35

inserts

(optional)

— satinised glass, light cone
with soft contour approx. 100°

13,45

— Fresnel lens, light cone
with soft contour approx. 60°

28,57

options

light source

2700K or 3000K, perfect color CRI97
pro version also available in 4000K, perfect color CRI97

surfaces

head/cover*

chrome

shiny chrome

colors

matt white

matt black

matt gold

materials/phantom/black phantom

rose gold

bronze

phantom

black phantom

tube/ceiling edge (edge)

matt white

matt black

*head and tube for edge version only available in matt white and matt black
The surfaces rose gold, bronze, phantom and black phantom may differ slightly from other product lines.

further options - accessories for Occhio air from page 226

These and further options can be configured at
Occhio Digital Order System (DOS)

further information - technical data and information on mounting options view pages 161–164

io spotlights
recessed spotlights



piano pure

piano v pure

for recessed mounting
seamless mounting incl. mounting board
incl. driver (trailing-edge phase cut dimmable)

360° rotatable, swivel range 45°

non-rotatable, non-swiveling

version



13W (1010lm)

chrome/colors

421,85

materials

+67,23

phantom/black phantom

+100,84

304,20

+67,23

+100,84

C
lens 80°
incl. soft edge glass

can also be configured as pro version
excl. power supply at Digital Order System (DOS)

can also be configured as pro version
excl. power supply at Digital Order System (DOS)

control

features

»cc« version (constant current)
incl. remote power supply

Occhio air module

Bluetooth dimmer module,
mounting in hollow ceiling or
switch box, for max. 4 spotlights
82,35

inserts

(optional)

— satinised glass, light cone
with soft contour approx. 100°

13,45

— Fresnel lens, light cone
with soft contour approx. 60°

28,57

options

light source

2700K or 3000K, perfect color CRI97
pro version also available in 4000K, perfect color CRI97

surfaces

head/cover*

chrome

shiny chrome

colors

matt white

matt black

matt gold

materials/phantom/black phantom

rose gold

bronze

phantom

black phantom

tube

matt white

matt black







The surfaces rose gold, bronze, phantom and black phantom may differ slightly from other product lines.

further options - accessories for Occhio air from page 226

These and further options can be configured at
Occhio Digital Order System (DOS)





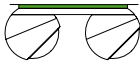

further information - technical data and information on mounting options view pages 161–164

io spotlights mounting accessories

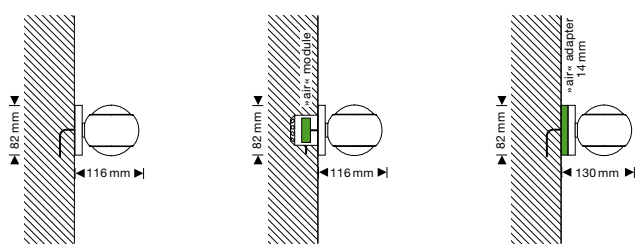
sideways inlet (single- or double-sided) through-wiring set for io spotlights for all surface-mounted versions H 7 mm, ø 76 mm		matt white	28,57
canopy with outlet on one or both sides for all surface-mounted versions, H 15 mm, ø 88 mm		shiny chrome glossy white matt chrome matt white matt black	55,46
cavity box for mounting of flat luminaires in hollow ceilings and -walls			3,36
mirror assembly kit for mounting the luminaires io verticale directly on a mirror, (drilling diameter 70 mm) no possibility of revision of the power supply via mirrors for flat versions			43,70
Occhio air module Bluetooth 4.0 dim module for phase-cut dimmable luminaires and power supply units, mounting in cavity or switch box, max. 4 x 32 W (with Occhio converter, other converters max. 52 W), L 40 mm x W 36 mm x H 14 mm			82,35
Occhio air adapter for io verticale adapter ring incl. »air« module, mounting under luminaire, ø 82 mm, H 14 mm		matt white matt black	110,92
for io giro/io alto v adapter ring incl. »air« module, mounting under luminaire, ø 77 mm, H 10 mm		matt white matt black	110,92
for io giro doppio adapter ring incl. »air« module, mounting under luminaire, L 196 mm x W 51 mm x H 7 mm		matt white matt black	110,92
inserts	satinised glass Fresnel lens		13,45 28,57

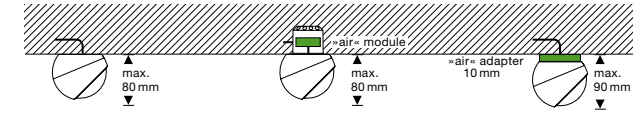
Can be configured at **Occhio Digital Order System (DOS)**

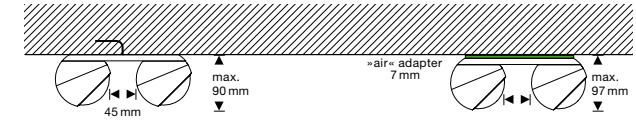
io spotlights mounting options

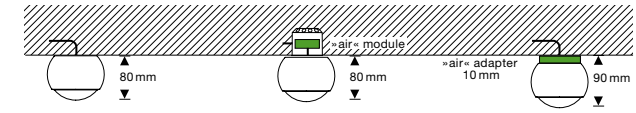
verticale head ø 100 mm, L 116 mm	 360° rotatable	solid wall with 230V power supply, through-wiring possible	
giro head ø 100 mm, H 80 mm	 45° swivel angle 360° rotatable	solid wall with 230V power supply, through-wiring possible	
giro doppio head ø 100 mm, H 80 mm base L 222 mm x W 76 mm x H 11 mm	 45° swivel angle 360° rotatable	solid wall with 230V power supply, through-wiring possible	
alto v head ø 100 mm, H 80 mm	 non swiveling	solid wall with 230V power supply	

io spotlights piano mounting options

piano edge
head H50 mm, ø100 mm



optional with Occhio air

edge mounting tube

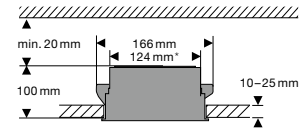

hollow ceiling

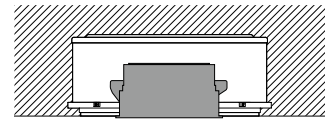

concrete ceiling
(Kaiser HaloX 250 with mineral-fibre board)
power supply max. L 210 mm x H 30 mm

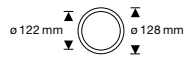

ceiling edge

piano v edge
head H 50 mm, ø100 mm



optional with Occhio air

edge mounting tube

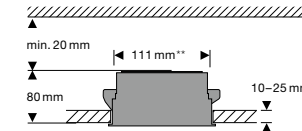

hollow ceiling

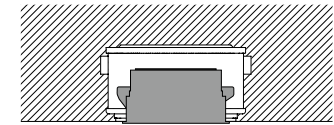

concrete ceiling
(Kaiser HaloX 180 with mineral-fibre board)
power supply max. L 130 mm x H 30 mm



ceiling edge

piano cover
head H50 mm, ø100 mm



optional with Occhio air

mounting tube with cover

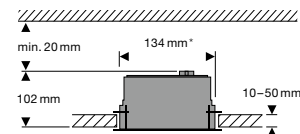

hollow ceiling

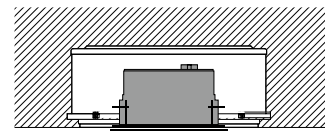

concrete ceiling
(Kaiser HaloX 250 with mineral-fibre board)
power supply max. L 210 mm x H 30 mm



cover

piano v cover
head H 50 mm, ø100 mm



optional with Occhio air

mounting tube with cover

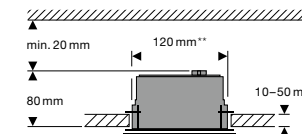

hollow ceiling

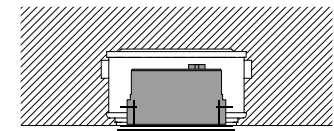

concrete ceiling
(Kaiser HaloX 180 with mineral-fibre board)
power supply max. L 130 mm x H 30 mm

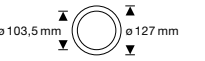

cover

piano pure
head H50 mm, ø100 mm

as pro version excl.
remote power supply available



optional with Occhio air

mounting board for seamless mounting

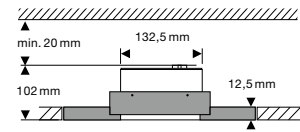

hollow ceiling
(fibre cement board with holding ring)

flush-mount ring for seamless mounting

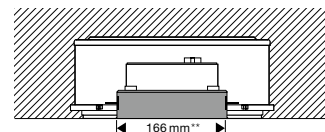

concrete ceiling plastered, no fair-faced concrete
(Kaiser HaloX 250 with mineral-fibre board)
power supply max. L 210 mm x H 30 mm

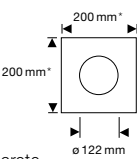

piano pure
head H 50 mm, ø100 mm

as pro version excl.
remote power supply available



optional with Occhio air

mounting board for seamless mounting

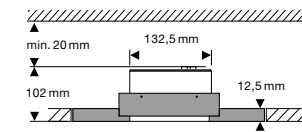

hollow ceiling
(fibre cement board with holding ring)

flush-mount ring for seamless mounting

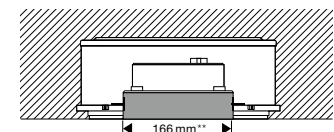

concrete ceiling plastered, no fair-faced concrete
(Kaiser HaloX 250 with mineral-fibre board)
power supply max. L 210 mm x H 30 mm

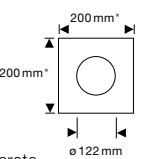

*compatible dimmers: occhio.com/dim
**cut-out dimension

io spotlights technical data and control



Occhio VOLT light engine

connection	U	230V AC/50Hz
average service life	t	>40.000h
energy-efficiency class	EEK	G

LED		perfect color
color temperature	T	2700K, 3000K
Color Rendering Index	CRI	Ra 97
recommended use		residential and public

power	P	perfect color	
luminous flux luminaire	φ	13W	18W

giro/alto v			
C		650lm	
verticale			
D		570lm	1020lm

control

Occhio air
powered by
Casambi

io spotlights VOLT luminaires dimmable via trailing-edge phase cut dimmer*.
List of compatible dimmer see below occhio.com/dim.

 **Occhio air**
control via Bluetooth – switching, dimming of individual luminaires, groups and scenes.

*compatible dimmers: occhio.com/dim

io 3d
table and floor luminaires

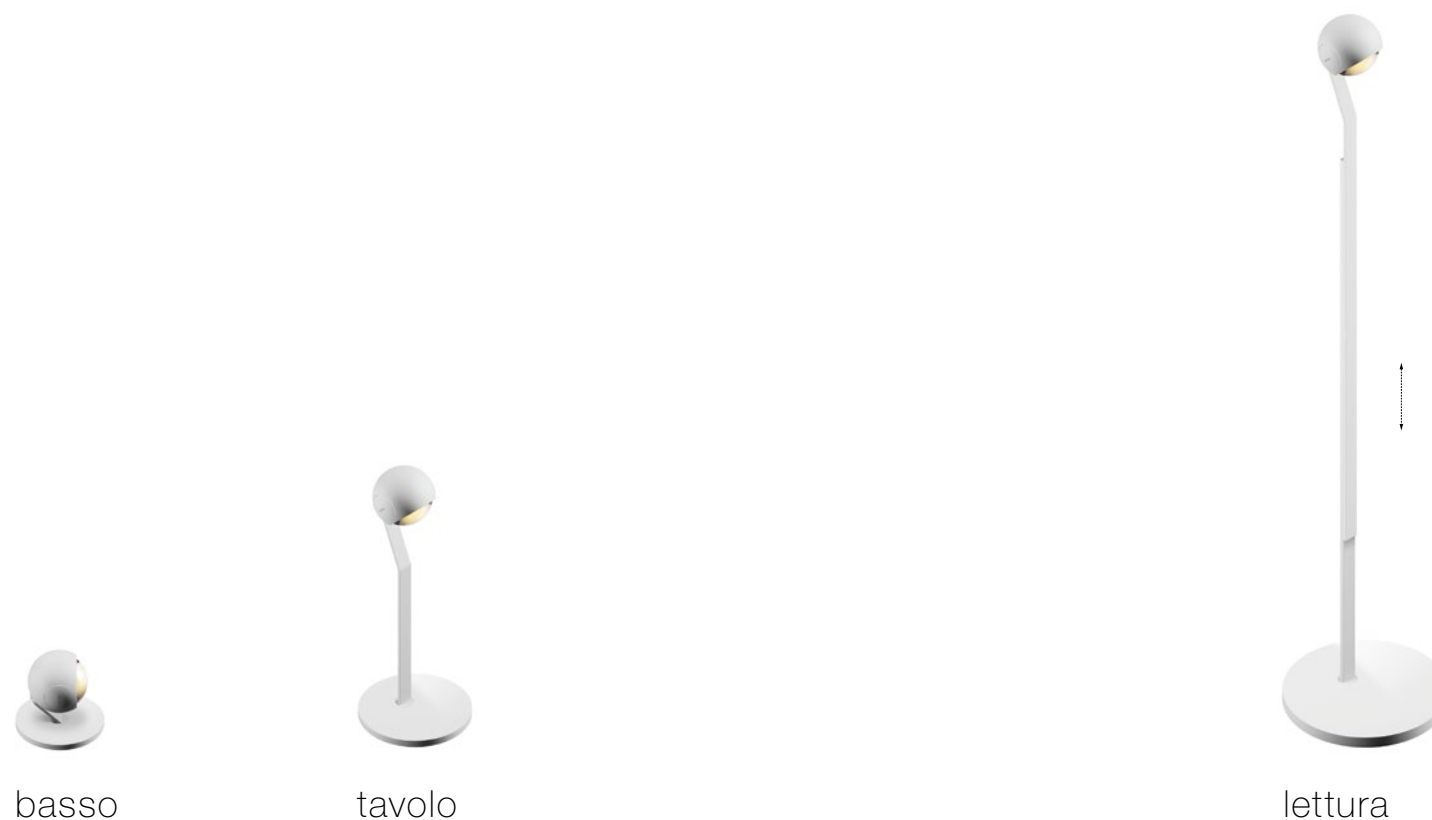

basso

tavolo

lettura

14 cm

40 cm

120–150 cm
height adjustable

head and body 360° rotatable
pads exchangeable
incl. plug-in power supply

version



18 W (800 lm)

chrome/colors 586,55
materials +67,23
phantom/black phantom +100,84

677,31

1.136,13
+67,23
+100,84

C
lens
80°

control

features

switchable and dimmable via »touchless control«
power 13/18W switchable

inserts

— filter red 23,53
— filter green
— filter blue
— filter yellow
— filter magenta
(max. 13 W)

— satinised glass, light cone with soft contour approx. 100° 13,45
— soft edge glass, light cone with soft contour approx. 80° 16,81
— Fresnel lens, light cone with soft contour approx. 60° 28,57

options

light source

2700 K or 3000 K, perfect color CRI97

surfaces

head/pads/body/base
chrome

shiny chrome
chrome matt
glossy white/shiny chrome/glossy white



colors

matt white
matt black
matt gold/matt white
matt gold/matt black



materials/phantom/black phantom

rose gold/matt black
bronze/matt black
phantom/matt black
black phantom/matt black



The surfaces rose gold, bronze, phantom and black phantom may differ slightly from other product lines.

further information

- technical data view page 172

io 3d
wall and ceiling luminaires

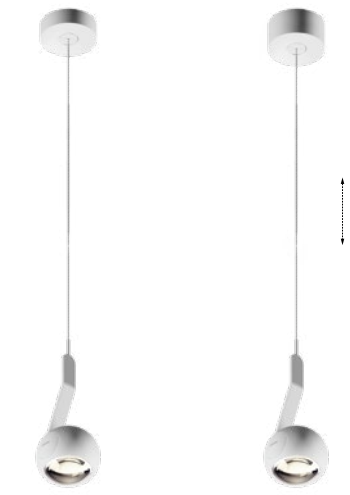

pico

sospeso

head and body 360° rotatable
pads and inserts exchangeable

up/flat

flat versions can be synced

fix, up/flat
cable length adjustable during mounting, 80–180 cm

variable, up/flat
continuous height adjustment 50–200 cm

version

	max.18W (1170lm)	chrome/colors	559,66
		materials	+67,23
		phantom/black phantom	+100,84

C
lens
80°

670,59	939,50
+67,23	
+100,84	

special lengths up to 1000 cm possible (surcharge +142,86, non discountable)
longer version, fix (180–280 cm) configurable (with surcharge)

control	features switchable and dimmable via »touchless control« (can be deactivated), alternatively dimmable via trailing-edge phase cut dimmer power 13/18W switchable	Occhio air module  Bluetooth dimmer module, mounting in hollow ceiling or switch box, for max. 4 spotlights 82,35	Occhio air adapter  adapter ring incl. »air« module, mounting under surface-mounted spacing box 110,92	inserts  filter red  filter green  filter blue  filter yellow  filter magenta (max. 13 W) 23,53	 satinised glass, light cone with soft contour approx. 100° 13,45  soft edge glass, light cone with soft contour approx. 80° 16,81  Fresnel lens, light cone with soft contour approx. 60° 28,57
----------------	--	---	--	--	--

options	light source 2700 K or 3000 K, perfect color CRI97	mounting options  with integrated converter for surface mounting, through-wiring possible	flat  with flat base for hollow ceiling with hollow ceiling box (incl. remote converter)	surfaces head/pads/body/base chrome shiny chrome chrome matt glossy white/shiny chrome/glossy white	colors  matt white  matt black  matt gold/matt white  matt gold/matt black	materials/phantom/black phantom  rose gold/matt black  bronze/matt black  phantom/matt black  black phantom/matt black
----------------	--	---	---	--	---	---







The surfaces rose gold, bronze, phantom and black phantom may differ slightly from other product lines.

further options - further mounting accessories view page 170
- accessories for Occhio air from page 226

These and further options can be configured at **Occhio Digital Order System (DOS)**

further information - technical data and information on mounting options view pages 171–172

io 3d mounting accessories

sideways inlet (single- or double-sided) for all surface-mounted versions, H 7 mm, ø 76 mm (ø base 88 mm)		matt white	28,57
canopy with outlet on one or both sides for all surface-mounted versions, H 15 mm, ø 88 mm		shiny chrome glossy white matt chrome matt white matt black	55,46
cable redirection for sospeso H 18 mm, ø 15 mm		shiny chrome matt chrome matt white matt black	35,29
mirror assembly kit for mounting the luminaires io pico directly on a mirror, (drilling diameter 70 mm) no possibility of revision of the power supply via mirrors			43,70
cavity box for mounting of flat luminaires in hollow ceilings and -walls			3,36
Occhio air module Bluetooth 4.0 dim module for phase-cut dimmable luminaires and power supply units, mounting in cavity or switch box, max. 4 x 32 W (with Occhio converter, other converters max. 52 W), L 40 mm x W 36 mm x H 14 mm			82,35
Occhio air adapter adapter ring incl. »air« module, mounting under luminaire, ø 88 mm, H 14 mm		matt white matt black	110,92
inserts			
	satinised glass		13,45
	soft edge glass		16,81
	Fresnel lens		28,57
	filter red		23,53
	filter green		
	filter blue		
	filter yellow		
	filter magenta		

Can be configured at **Occhio Digital Order System (DOS)**

io 3d mounting options

head Ø 100 mm

up
with integrated power supply for surface mounting,
through-wiring possible

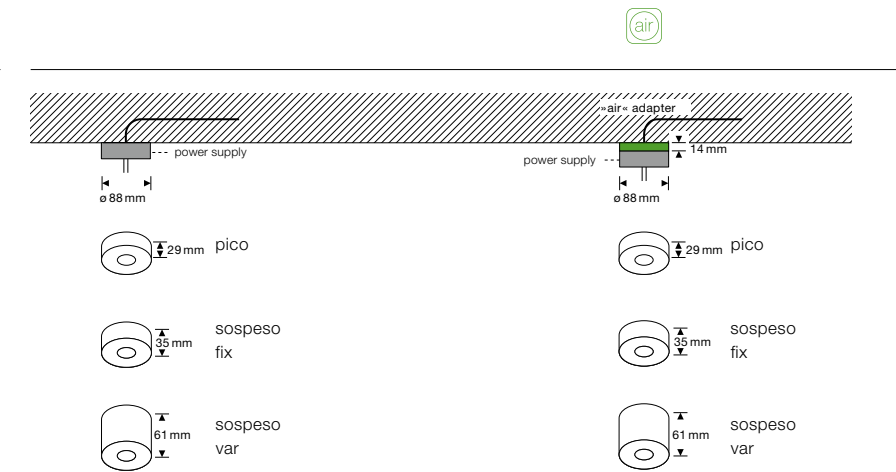

flat
with flat base for cavity box,
remote power supply

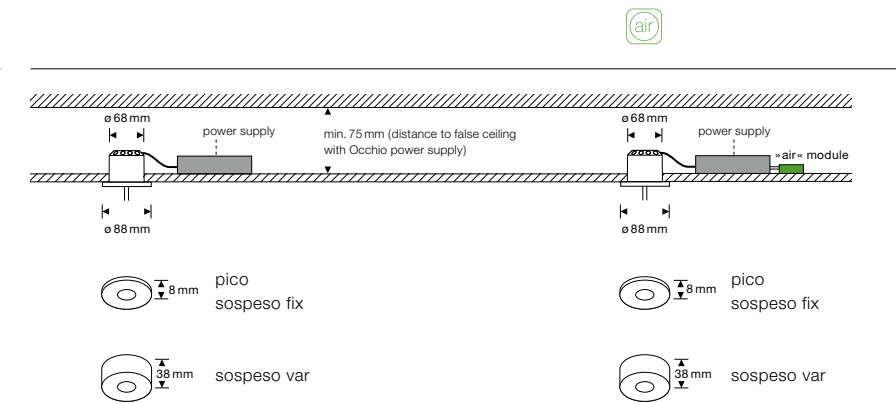

io 3d technical data and control

version »touchless control«

connection	U	48 V DC (min. 22 W)
average service life	t	> 50.000 h
energy-efficiency class	EEK	G

LED		perfect color
color temperature	T	2700 K, 3000 K
Color Rendering Index	CRI	Ra 97
recommended use		residential and public

power	P	perfect color
luminous flux luminaire	ϕ	13 W 18 W
C		800 lm 1170 lm

control

with Occhio power supply

The Occhio power supply is perfectly matched to these requirements and can be dimmed by trailing-edge phase cut dimmer*. Can not be used in conjunction with »touchless control« or Occhio air.

*Occhio air
powered by
Casambi*

 **Occhio air**
control via Bluetooth – switching, dimming of individual luminaires, groups and scenes.

touchless dim funktion io luminaire heads

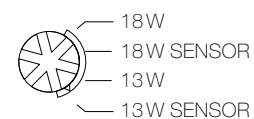

18 W/13 W
luminaires are dimmed using remote trailing-edge phase cut dimmers*
(except for floor and table luminaires) or controlled with Occhio air (optional), (switching, dimming).

18 W SENSOR/13 W SENSOR
luminaires can be controlled by the »touchless control« with simple gestures integrated in the head
(switching, dimming) – cannot be combined with Occhio air.

*compatible dimmers: occhio.com/dim

M series

lui

The lui spotlight system is lighting technology in its most beautiful form: interchangeable optics like in the field of photography open new lighting possibilities – with top quality of light and maximum efficiency.



lui spotlights

ceiling spotlights



zoom continuously adjustable light cone volto alto alto v alto doppio lens fixed light cone volto alto alto v alto doppio

through-wiring possible 360° rotatable swivel range 90° for surface mounting 360° rotatable swivel range 45° mounting on ceiling box non-swiveling for surface mounting 360° rotatable swivel range 45° for surface mounting through-wiring possible 360° rotatable swivel range 90° for surface mounting 360° rotatable swivel range 45° mounting on ceiling box non-swiveling for surface mounting 360° rotatable swivel range 45° for surface mounting

version*	18W (420lm) 13W (310lm)	colors shiny chrome	561,34	448,74	351,26	944,54	18W (540lm) 13W (400lm)	colors shiny chrome	542,86	430,25	332,77	907,56
	18W (420lm)	materials	+16,81			+33,61	18W (540lm)	materials	+16,81			+33,61
	18W (420lm)	phantom/black phantom	+25,21			+50,42	18W (540lm)	phantom/black phantom	+25,21			+50,42

zoom
20°–60°/soft edge glass
+ zoom optic

C 80
80°/clear glass + small lens medium
+ lens optic

	18W (540lm) 13W (400lm)	colors shiny chrome	542,86	430,25	332,77	907,56	18W (540lm)	materials	+16,81			+33,61
	18W (540lm)	phantom/black phantom	+25,21			+50,42	18W (540lm)	phantom/black phantom	+25,21			+50,42

S 80
80°/soft edge glass + small lens medium
+ lens optic

	18W (450lm) 13W (340lm)	colors shiny chrome	542,86	430,25	332,77	907,56	18W (450lm)	materials	+16,81			+33,61
	18W (450lm)	phantom/black phantom	+25,21			+50,42	18W (450lm)	phantom/black phantom	+25,21			+50,42

S 40
40°/Fresnel lens + small lens medium
+ lens optic

*doppio versions: 2 x 18W/13W

*doppio versions: 2 x 18W/13W

control	features	Occhio air module	Occhio air adapter	inserts
	230V light engine dimmable via trailing-edge phase cut dimmer, max. light output, adjustable via rotary knob on the rear side of the head	Bluetooth dimming module, for mounting in hollow ceiling or switch box (can be put in doppio base), for max. 4 spotlights	adapter ring incl. »air« module (only volto + alto v), mounting under luminaire	<ul style="list-style-type: none"> filter red filter green filter blue filter yellow filter magenta (for zoom-optics)
		82,35	110,92	30,25

options	light source	surfaces	head/optics/base	materials/phantom/black phantom
	2700K or 3000K, perfect color CRI97	chrome shiny chrome**	colors matt white matt black matt white/matt gold/matt white matt black/matt gold/matt black	matt black/rose gold/matt black matt black/bronze/matt black matt black/phantom/matt black matt black/black phantom/matt black
			**always matt white for doppio base The surfaces rose gold, bronze, phantom and black phantom may differ slightly from other product lines.	

further options - further lighting effects view page 190
- further mounting accessories view page 186
- further accessories for Occhio air from page 226

These and further options can be configured at **Occhio Digital Order System (DOS)**

further information - technical data and information on mounting options view pages 187–191

lui spotlights

track spotlights



zoom continuously adjustable light cone

alto track

swivel range 55°
360° rotatable
with in-trac adapter, for Eutrac, Erco and Zumtobel 3-phase tracks

version



18W (420lm)	colors	443,70
13W (310lm)	shiny chrome	
18W (420lm)	materials	+ 16,81
	phantom/black phantom	+25,21

zoom

20°–60°/soft edge glass
+ zoom optic



lens fixed light cone

alto track

swivel range 55°
360° rotatable
with in-trac adapter, for Eutrac, Erco and Zumtobel 3-phase tracks

version



18W (540lm)	colors	425,21
13W (400lm)	shiny chrome	
18W (540lm)	materials	+ 16,81
	phantom/black phantom	+25,21

C 80

80°/clear glass + small lens medium
+ lens optic



18W (540lm)	colors	425,21
13W (400lm)	shiny chrome	
18W (540lm)	materials	+ 16,81
	phantom/black phantom	+25,21

S 80

80°/soft edge glass + small lens medium
+ lens optic



18W (450lm)	colors	425,21
13W (340lm)	shiny chrome	
18W (450lm)	materials	+ 16,81
	phantom/black phantom	+25,21

S 40

40°/Fresnel lens small + lens medium
+ lens optic

control

features



230V light engine
dimnable via trailing-edge phase cut dimmer, max. light output, adjustable via rotary knob on the rear side of the head

inserts

	filter red	30,25
	filter green	
	filter blue	
	filter yellow	
	filter magenta	
(for zoom-optics)		

options

light source

2700K or 3000K, perfect color CRI97

surfaces

head/optics/adaptor chrome

shiny chrome/matt white
shiny chrome/matt chrome



colors

matt white
matt black
matt white/matt gold/matt white
matt black/matt gold/matt black



head/optics/base materials/phantom/black phantom

matt black/rose gold/matt black
matt black/bronze/matt black
matt black/phantom/matt black
matt black/black phantom/matt black



The surfaces rose gold, bronze, phantom and black phantom may differ slightly from other product lines.

further options

- further lighting effects view page 190
- further accessories for Occhio air from page 226

These and further options can be configured at
Occhio Digital Order System (DOS)

further information

- technical data and information on mounting options view pages 187–191

lui spotlights

recessed spotlights



ZOOM continuously adjustable light cone

piano edge

piano cover round

piano cover square

lens fixed light cone

piano edge

piano cover round

piano cover square

360° rotation, swivel range 45° incl. driver (trailing-edge phase cut dimmable)

for recessed mounting with filigree ceiling edge

for recessed mounting with cover round

for recessed mounting with cover square

360° rotation, swivel range 45° incl. driver (trailing-edge phase cut dimmable)

for recessed mounting with filigree ceiling edge

for recessed mounting with cover round

for recessed mounting with cover square

version



18W (890lm)	chrome/colors	299,16	379,83	379,83
	materials	+16,81	+33,61	
	phantom/black phantom	+25,21	+50,42	

zoom
20°–60°/soft edge glass + zoom optic

version



18W (1010lm)	chrome/colors	280,67	361,34	361,34
	materials	+16,81	+33,61	
	phantom/black phantom	+25,21	+50,42	

C 80
80°/clear glass + small lens medium + lens optic



18W (1010lm)	chrome/colors	280,67	361,34	361,34
	materials	+16,81	+33,61	
	phantom/black phantom	+25,21	+50,42	

S 80
80°/soft edge glass + small lens medium + lens optic



18W (910lm)	chrome/colors	280,67	361,34	361,34
	materials	+16,81	+33,61	
	phantom/black phantom	+25,21	+50,42	

S 40
40°/Fresnel lens + small lens medium + lens optic

can also be configured as pro version
excl. power supply at Digital Order System (DOS)

can also be configured as pro version
excl. power supply at Digital Order System (DOS)

control

features

»cc« version (constant current)
incl. remote power supply

Occhio air module

Bluetooth dimming module, for mounting in hollow ceiling or switch box for max. 4 spotlights

82,35

inserts

- filter red 30,25
- filter green
- filter blue
- filter yellow
- filter magenta

(for zoom-optics)

options

light source

2700K or 3000K, perfect color CRI97
pro version also available in 4000K, perfect color CRI97

surfaces

optics/cover*

- chrome
- shiny chrome
- matt chrome

colors

- matt white
- matt black
- matt gold

materials/phantom/black phantom

- rose gold
- bronze
- phantom
- black phantom

tube*/ceiling edge

- matt white
- matt black

*tube only available in matt white and matt black
The surfaces rose gold, bronze, phantom and black phantom may differ slightly from other product lines.

further options
- further lighting effects view page 190
- further accessories for Occhio air from page 226

These and further options can be configured at
Occhio Digital Order System (DOS)

further information - technical data and information on mounting options view pages 187–191

lui spotlights

recessed spotlights



zoom continuously adjustable light cone

piano v
edge

piano v
cover round

piano v
cover square

lens fixed light cone

piano v
edge

piano v
cover round

piano v
cover square

non-swiveling
incl. driver (trailing-edge phase cut dimmable)

non-rotatable
for recessed mounting
with filigree ceiling edge

for recessed mounting
with cover round

for recessed mounting
with cover square

non-swiveling
incl. driver (trailing-edge phase cut dimmable)

non-rotatable
for recessed mounting
with filigree ceiling edge

for recessed mounting
with cover round

for recessed mounting
with cover square

version



18 W (890lm)	chrome/colors	226,89
	materials	+ 16,81
	phantom/black phantom	+ 25,21

262,18
+ 33,61
+ 50,42

262,18

zoom

20°–60°/soft edge glass
+ zoom optic

version



18 W (1010lm)	chrome/colors	208,40
	materials	+ 16,81
	phantom/black phantom	+ 25,21

243,70
+ 33,61
+ 50,42

243,70

C 80

80°/clear glass + small lens medium
+ lens optic



18 W (1010lm)	chrome/colors	208,40
	materials	+ 16,81
	phantom/black phantom	+ 25,21

243,70
+ 33,61
+ 50,42

243,70

S 80

80°/soft edge glass + small lens medium
+ lens optic



18 W (910lm)	chrome/colors	208,40
	materials	+ 16,81
	phantom/black phantom	+ 25,21

243,70
+ 33,61
+ 50,42

243,70

S 40

40°/Fresnel lens + small lens medium
+ lens optic

can also be configured as pro version
excl. power supply at Digital Order System (DOS)

can also be configured as pro version
excl. power supply at Digital Order System (DOS)

control

features

»cc« version (constant current)
incl. remote power supply

Occhio air module

Bluetooth dimming module,
for mounting in hollow ceiling or
switch box for max. 4 spotlights

82,35

inserts

- filter red
- filter green
- filter blue
- filter yellow
- filter magenta

(for zoom-optics)

options

light source

2700 K or 3000 K, perfect color CRI97
pro version also available in 4000 K, perfect color CRI97

surfaces

optics/cover*

- chrome
- shiny chrome
- matt chrome

colors

- matt white
- matt black
- matt gold

materials/phantom/black phantom

- rose gold
- bronze
- phantom
- black phantom

tube*/ceiling edge

- matt white
- matt black

*tube only available in matt white and matt black
The surfaces rose gold, bronze, phantom and black phantom may differ slightly from other product lines.

further options

- further lighting effects view page 190
- further accessories for Occhio air from page 226

These and further options can be configured at
Occhio Digital Order System (DOS)

further information

- technical data and information on mounting options view pages 187–191

lui spotlights

recessed spotlights



piano v pure



lens



piano pure

piano v pure

ZOOM continuously adjustable light cone

piano pure

non-swiveling

lens fixed light cone

360° rotatable
swivel range 45°

non-swiveling

for recessed mounting
seamless mounting incl. mounting board
incl. driver (trailing-edge phase cut dimmable)

360° rotatable
swivel range 45°

for recessed mounting
seamless mounting incl. mounting board
incl. driver (trailing-edge phase cut dimmable)

version



18W (890lm)	chrome/colors	421,85
	materials	+ 16,81
	phantom/black phantom	+25,21

304,20

zoom

20°–60°/soft edge glass
+ zoom optic

version



18W (1010lm)	chrome/colors	403,36
	materials	+ 16,81
	phantom/black phantom	+25,21

285,71

C 80

80°/clear glass + small lens medium
+ lens optic



18W (1010lm)	chrome/colors	403,36
	materials	+ 16,81
	phantom/black phantom	+25,21

285,71

S 80

80°/soft edge glass + small lens medium
+ lens optic



18W (910lm)	chrome/colors	403,36
	materials	+ 16,81
	phantom/black phantom	+25,21

285,71

S 40

40°/Fresnel lens + small lens medium
+ lens optic

can also be configured as pro version
excl. power supply at Digital Order System (DOS)

can also be configured as pro version
excl. power supply at Digital Order System (DOS)

control

features

»cc« version (constant current)
incl. remote power supply

Occhio air module

Bluetooth dimming module,
for mounting in hollow ceiling or
switch box for max. 4 spotlights

82,35

inserts

	filter red	30,25
	filter green	
	filter blue	
	filter yellow	
	filter magenta	

(for zoom-optics)

options

light source

2700K or 3000K, perfect color CRI97
pro version also available in 4000K, perfect color CRI97

surfaces

optics

chrome	
shiny chrome	
matt chrome	

colors

matt white	
matt black	
matt gold	

materials/phantom/black phantom

rose gold	
bronze	
phantom	
black phantom	

tube*

matt white	
matt black	

*for tube further surfaces can be configured.
The surfaces rose gold, bronze, phantom and black phantom may differ slightly from other product lines.

further options







- further lighting effects view page 190
- further accessories for Occhio air from page 226

These and further options can be configured at
Occhio Digital Order System (DOS)

further information

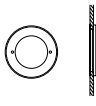



- technical data and information on mounting options view pages 187–191

lui spotlights mounting accessories

sideways inlet (single- or double-sided) for all surface-mounted versions, H 7 mm, ø 76 mm (ø base 88 mm)		matt white	28,57
canopy with outlet on one or both sides for all surface-mounted versions, H 15 mm, ø 88 mm		shiny chrome glossy white matt chrome matt white matt black	55,46
mirror assembly kit for mounting the luminaires io pico directly on a mirror, (drilling diameter 70 mm) no possibility of revision of the power supply via mirrors			43,70
cavity box for mounting of flat luminaires in hollow ceilings and -walls			3,36
Occhio air module Bluetooth 4.0 dim module for phase-cut dimmable spotlights and power supply units, mounting in cavity or switch box, max. 4 x 32 W (with Occhio converter, other converters max. 52 W), L 40 mm x W 36 mm x H 14 mm			82,35
Occhio air adapter for lui volto/alto v adapter ring incl. »air« module, mounting under luminaire, ø 95 mm, H 10 mm		matt white matt black	110,92
for lui 3d adapter ring incl. »air« module, mounting under luminaire, ø 88 mm, H 14 mm		matt white matt black	110,92
color filter for zoom optic	filter red filter green filter blue filter yellow filter magenta		30,25

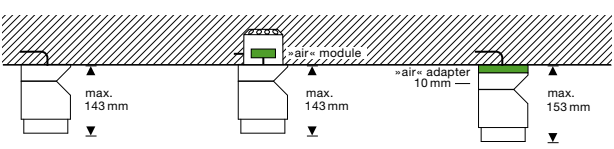
Can be configured at **Occhio Digital Order System (DOS)**

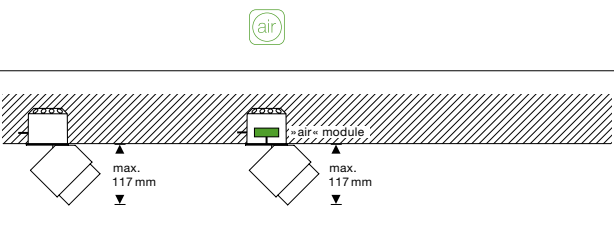
lui spotlights mounting options

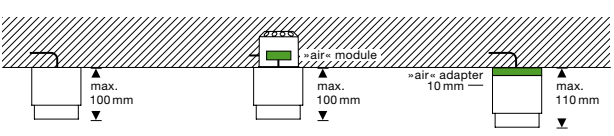
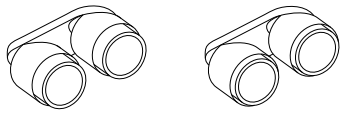
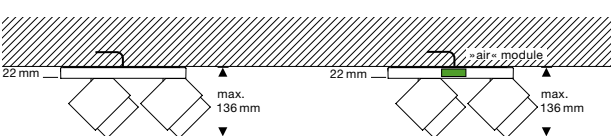
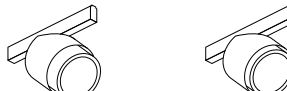
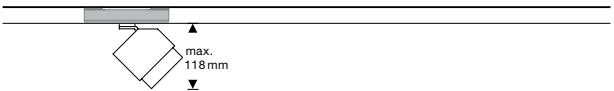
volto head ø 94 mm, H 143 mm (zoom), H 131 mm (lens)		solid wall with 230 V power supply, through-wiring possible	
90° swivel range 360° rotatable			
alto head ø 94 mm, H 117 mm (zoom), H 105 mm (lens)		solid wall with 230 V power supply, through-wiring possible	
45° swivel range 360° rotatable			
alto v ø 94 mm, H 100 mm (zoom), H 82 mm (lens)		solid wall with 230 V power supply, through-wiring possible	
non rotatable			
alto doppio head ø 94 mm, H 136 mm (zoom), H 125 mm (lens) base L 240 mm x W 85 mm x H 22 mm		solid wall with 230 V power supply, through-wiring possible	
45° swivel range 360° rotatable			
alto track head ø 94 mm, H 118 mm (zoom), H 108 mm (lens)		3-phase track, only for Eutrac, Erco and Zumtobel tracks	
55° swivel range 360° rotatable			

lui spotlights piano mounting options

piano edge
head ø94 mm, H99 mm (zoom), H85 mm (lens)



45° swivel range
360° rotatable

 optional with Occhio air

edge mounting tube

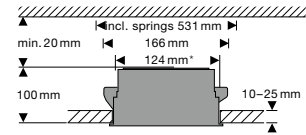

hollow ceiling

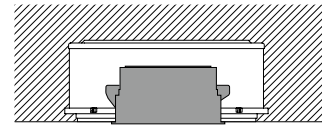

concrete ceiling
(Kaiser HaloX 250 with mineral-fibre board)
power supply max. L 210 mm x H 30 mm

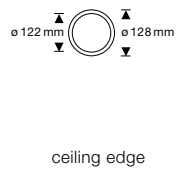

ceiling edge

piano v edge
head ø94 mm, H99 mm (zoom), H85 mm (lens)



non rotatable

 optional with Occhio air

edge mounting tube

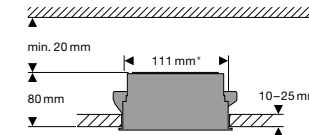

hollow ceiling

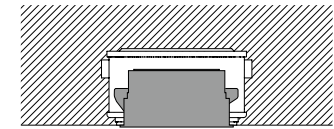

concrete ceiling
(Kaiser HaloX 180 with mineral-fibre board)
power supply max. L 130 mm x H 30 mm

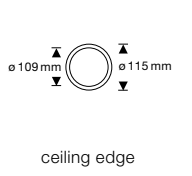

ceiling edge

piano cover
head ø94 mm, H99 mm (zoom), H85 mm (lens)

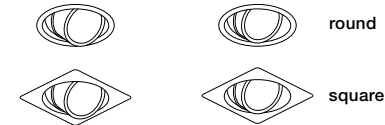

round

square

 optional with Occhio air

mounting tube with cover

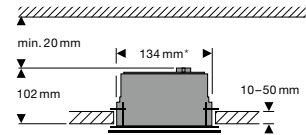

hollow ceiling

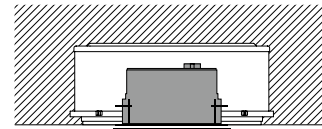

concrete ceiling
(Kaiser HaloX 250 with mineral-fibre board)
power supply max. L 210 mm x H 30 mm

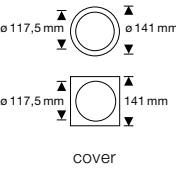

cover

piano v cover
head ø94 mm, H99 mm (zoom), H85 mm (lens)

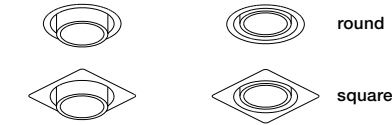

round

square

non rotatable

 optional with Occhio air

mounting tube with cover

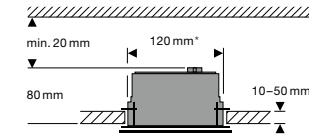

hollow ceiling

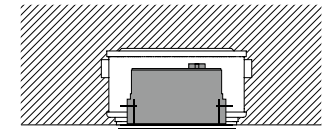

concrete ceiling
(Kaiser HaloX 180 with mineral-fibre board)
power supply max. L 130 mm x H 30 mm

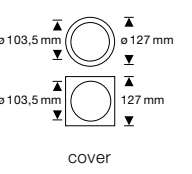

cover

piano pure
head ø94 mm, H99 mm (zoom), H85 mm (lens)

as pro version (=constant current=)
remote power supply (optional)

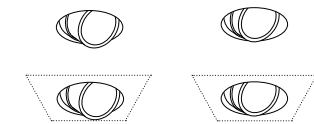

 optional with Occhio air

mounting board for seamless mounting

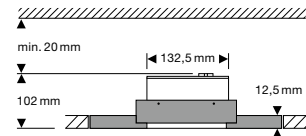

hollow ceiling
(fibre cement board with holding ring)

flush-mount ring for seamless

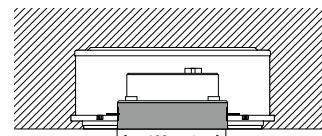

concrete ceiling plastered, no fair-faced concrete
(Kaiser HaloX 250 with mineral-fibre board)
power supply max. L 210 mm x H 30 mm

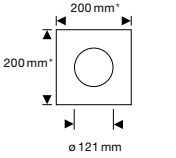

piano v pure
head ø94 mm, H99 mm (zoom), H85 mm (lens)

as pro version (=constant current=)
remote power supply (optional)



non swivable

 optional with Occhio air

mounting board for seamless mounting

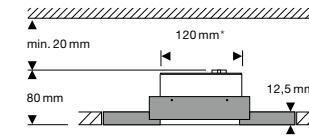

hollow ceiling
(fibre cement board with holding ring)

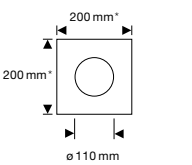

*cut-out dimension

lui spotlights lighting effects

head	zoom	lens
	continuously adjustable light cone	fixed light cone with insight lens (changeable)
 zoom	zoom 20°–60° soft edge glass + zoom optic	
 C 80		80°/clear glass + small lens medium + lens optic
 C 60		60°/clear glass + small lens high + lens optic
 S 80		80°/soft edge glass + small lens medium + lens optic
 S 60		60°/soft edge glass + small lens high + lens optic
 S 40		40°/Fresnel-lens + small lens medium + lens optic
 S 30		30°/Fresnel-lens + small lens high + lens optic

lui spotlights with these lighting effects are configurable at **Occhio Digital Order System (DOS)**

lui spotlights technical data and control



Occhio VOLT light engine

connection	U	230 V AC/50 Hz
average service life	t	> 40.000 h
energy-efficiency class	EEK	G

LED		perfect color
color temperature	T	2700 K, 3000 K
Color Rendering Index	CRI	Ra 97
recommended use		residential and public

power luminous flux luminaire	P φ	perfect color	
		13W	18W
zoom		420 lm	560 lm
lens	C 80	530 lm	720 lm
	C 60	530 lm	720 lm
	S 80	530 lm	720 lm
	S 60	530 lm	720 lm
	S 40	450 lm	600 lm
	S 30	470 lm	630 lm

control

Occhio air
powered by
Casambi

lui spotlights VOLT Leuchten are dimmable via trailing-edge phase cut dimmer*.

 **Occhio air**
control via Bluetooth – switching, dimming of individual luminaires, groups and scenes.

*compatible dimmers: occhio.com/dim

lui 3d

floor spotlights



zoom continuously adjustable light cone

basso

head and body 360° rotatable
incl. plug-in power supply

14 cm

version



18 W (890 lm)	chrome/colors	603,36
13 W (650 lm)	shiny chrome	
18 W (890 lm)	materials	+ 16,81
18 W (890 lm)	phantom/black phantom	+ 25,21

zoom

20°–60°/soft edge glass
+ zoom optic



lens fixed light cone

basso

head and body 360° rotatable
incl. plug-in power supply

14 cm

version



18 W (1100 lm)	chrome/colors	584,87
13 W (740 lm)	shiny chrome	
18 W (1100 lm)	materials	+ 16,81
18 W (1100 lm)	phantom/black phantom	+ 25,21

C 80

80°/clear glass + small lens medium
+ lens optic



18 W (1100 lm)	chrome/colors	584,87
13 W (740 lm)	shiny chrome	
18 W (1100 lm)	materials	+ 16,81
18 W (1100 lm)	phantom/black phantom	+ 25,21

S 80

80°/soft edge glass + small lens medium
+ lens optic



18 W (910 lm)	chrome/colors	584,87
13 W (660 lm)	shiny chrome	
18 W (910 lm)	materials	+ 16,81
18 W (910 lm)	phantom/black phantom	+ 25,21

S 40

40°/Fresnel lens + small lens medium
+ lens optic

control

features

switchable and dimmable at the head via rear slide control

inserts

	filter red	30,25
	filter green	
	filter blue	
	filter yellow	
	filter magenta	

(for zoom optics)

options

light source

2700 K or 3000 K, perfect color CRI 97

surfaces

head/optics/body/base

chrome

shiny chrome

matt chrome

colors

matt white

matt black

matt white/matt gold/matt white

matt black/matt gold/matt black

materials/phantom/black phantom

matt black/rose gold/matt black

matt black/bronze/matt black

matt black/phantom/matt black

matt black/black phantom/matt black

The surfaces rose gold, bronze, phantom and black phantom may differ slightly from other product lines.

further options

- further lighting effects view page 198

These and further options can be configured at
Occhio Digital Order System (DOS)

further information

- technical data view page 199

lui 3d

wall and ceiling luminaires



zoom continuously adjustable light cone

pico

head and body 360° rotatable

up/flat

version



18 W (890 lm)	chrome/colors	576,47
13 W (650 lm)	shiny chrome	
18 W (890 lm)	materials	+ 16,81
18 W (890 lm)	phantom/black phantom	+ 25,21

zoom

20°–60°/soft edge glass
+ zoom optic

can also be configured as pro version and pro power version with **26 W** excl. power supply at Digital Order System (DOS)

control

features

switchable and dimmable at the head via rear slide control, alternatively dimmable via trailing-edge phase cut dimmer

Occhio air module



Bluetooth dimming module, for mounting in hollow ceiling or switch box, for max. 4 spotlights

82,35

Occhio air adapter



adapter ring incl. »air« module, mounting under luminaire

110,92

options

light source

2700 K or 3000 K, perfect color CRI 97

mounting options

up



with integrated converter for surface mounting, through-wiring possible

flat



with flat base for hollow ceiling or switch box, incl. remote converter

inserts

	filter red	30,25
	filter green	
	filter blue	
	filter yellow	
	filter magenta	

(for zoom optics)

surfaces

head/optics/body/base

chrome

shiny chrome

matt chrome

colors

matt white

matt black

matt white/matt gold/matt white

matt black/matt gold/matt black



materials/phantom/black phantom

matt black/rose gold/matt black

matt black/bronze/matt black

matt black/phantom/matt black

matt black/black phantom/matt black



The surfaces rose gold, bronze, phantom and black phantom may differ slightly from other product lines.

further options







- further lighting effects view page 198
- further mounting accessories view page 196
- further accessories for Occhio air from page 226

These and further options can be configured at **Occhio Digital Order System (DOS)**

further information

- technical data and information on mounting options view pages 197–199

lui 3d mounting accessories

sideways inlet (single- or double-sided) for all surface-mounted versions, H 7 mm, ø 76 mm (ø base 88 mm)		matt white	28,57
canopy with outlet on one or both sides for all surface-mounted versions, H 15 mm, ø 88 mm		shiny chrome glossy white matt chrome matt white matt black	55,46
mirror assembly kit for mounting the luminaires io pico directly on a mirror, (drilling diameter 70 mm) no possibility of revision of the power supply via mirrors			43,70
cavity box for mounting of flat luminaires in hollow ceilings and -walls			3,36
Occhio air module Bluetooth 4.0 dim module for phase-cut dimmable spotlights and power supply units, mounting in cavity or switch box, max. 4 x 32 W (with Occhio converter, other converters max. 52 W), L 40 mm x W 36 mm x H 14 mm			82,35
Occhio air adapter for lui volto/alto v adapter ring incl. »air« module, mounting under luminaire, ø 95 mm, H 10 mm		matt white matt black	110,92
for lui 3d adapter ring incl. »air« module, mounting under luminaire, ø 88 mm, H 14 mm		matt white matt black	110,92
color filter for zoom optic	filter red filter green filter blue filter yellow filter magenta		30,25

Can be configured at **Occhio Digital Order System (DOS)**

lui 3d mounting options

pico up
 with integrated power supply for surface
 mounting, suitable for wall mounting
 (outside the hand area),
 through-wiring possible

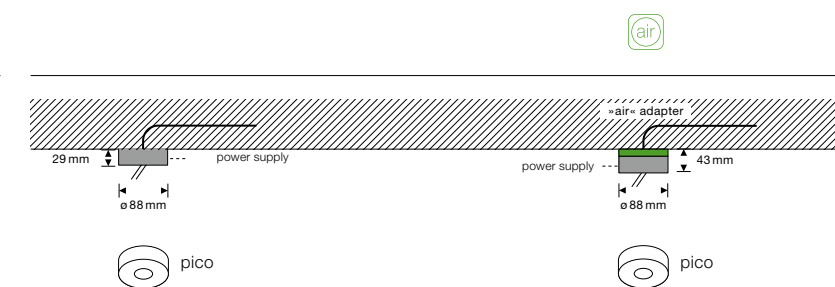

pico flat
 with flat base for cavity box,
 remote power supply
 suitable for wall mounting
 (outside the hand area),
 through-wiring possible

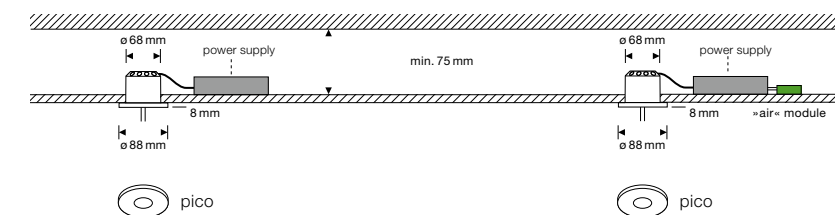

lui 3d lighting effects

head	zoom	lens
	continuously adjustable light cone	fixed light cone with insight lens (changeable)
 zoom	zoom 20°–60° soft edge glass + zoom optic	
contour		
 C80		80°/clear glass + small lens medium + lens optic
 C60		60°/clear glass + small lens high + lens optic
soft		
 S80		80°/soft edge glass + small lens medium + lens optic
 S60		60°/soft edge glass + small lens high + lens optic
 S40		40°/Fresnel-lens + small lens medium + lens optic
 S30		30°/Fresnel-lens + small lens high + lens optic

lui 3d spotlights with these lighting effects are configurable at **Occhio Digital Order System (DOS)**

lui 3d technical data and control

version »slide control«

connection U 48V DC (min. 22W)

average service life t > 50.000 h
energy-efficiency class EEK G

LED
color temperature T 2700K, 3000K
Color Rendering Index CRI Ra 97
recommended use residential and public

power	luminous flux luminaire	perfect color	
		13W	18W
zoom		650lm	890lm
lens	C80	740lm	1010lm
	C60	770lm	1040lm
	S80	740lm	1010lm
	S60	740lm	1010lm
	S40	660lm	910lm
	S30	690lm	940lm

control

with Occhio power supply

The Occhio power supply is perfectly matched to these requirements and can be dimmed by trailing-edge phase cut dimmer*. Not in connection with dimming function or slight control or Occhio air.

Occhio air
powered by
Casambi

 **Occhio air**
control via Bluetooth – switching, dimming of individual luminaires, groups and scenes.

dim function lui luminaire heads



lui 3d luminaires are switchable and dimmable at the head via rear slight control.
For external dimming or for use with Occhio air, set the slight control to »100«.

*compatible dimmers: occhio.com/dim

M series

lei

The first shade luminaire with changeable characteristics.

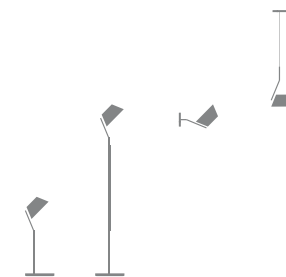

lei 3d
table and floor luminaires



tavolo

40 cm

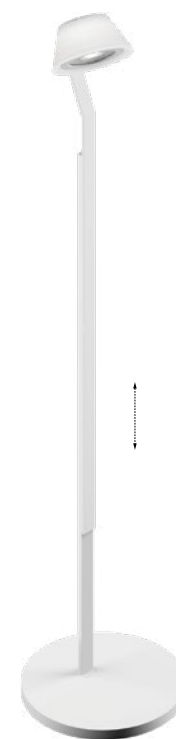

lettura

120–150 cm
height adjustable

head and body 360° rotatable
incl. plug-in power supply

version



9W (610lm)

colors

630,25

materials

+16,81

phantom

+26,89

1.089,08

+16,81

+26,89

iris for flexible setting of direct and ambient light proportions

control

features

switchable and dimmable via sensor button on the rear side of the head

options

light source

2700K or 3000K, perfect color CRI97

surfaces

iris + cover/body/base

chrome

shiny chrome
matt chrome
glossy white/shiny chrome/glossy white



colors

matt white
matt black
matt gold/matt white
matt gold/matt black



materials/phantom/black phantom

rose gold/matt black
bronze/matt black
phantom/matt black
black phantom/black matt



head matt white/translucent

The surfaces rose gold, bronze, phantom and black phantom may differ slightly from other product lines.

further information





- technical data view page 208

lei 3d
wall and suspended luminaires



parete

sospeso

head and body 360° rotatable		15 cm, up/flat		head and body 360° rotatable		fix, up/flat cable length adjustable during mounting, 80–180 cm		variable, up/flat continuous height adjustment 50–200 cm	
version	 9W (610lm)	colors	532,77	materials	+16,81	phantom	+26,89	623,53	892,44
iris for flexible setting of direct and ambient light proportions								☉ special length up to 1000 cm possible (extra charge per head: +142,86, non discountable) longer version, fix (180–280 cm) configurable (with surcharge)	
control	features switchable and dimmable via sensor button on the rear side of the head (can be deactivated), alternatively dimmable via trailing-edge phase cut dimmer	Occhio air module  Bluetooth dimmer module, mounting in hollow ceiling or switch box, for max. 4 spotlights 82,35	Occhio air adapter  adapter ring incl. »air« module, mounting under surface-mounted spacing box 110,92						
options	light source 2700 K or 3000 K, perfect color CRI97	mounting variations up  with integrated converter for surface mounting, through-wiring possible	flat  with flat base for hollow ceiling with hollow ceiling box incl. remote converter	surfaces	iris + cover/body/base chrome shiny chrome matt chrome glossy white/shiny chrome/glossy white	colors matt white matt black matt gold/matt white matt gold/matt black	materials/phantom/black phantom rose gold/matt black bronze/matt black phantom/matt black black phantom/black matt	head matt white/translucent The surfaces rose gold, bronze, phantom and black phantom may differ slightly from other product lines.	
further options	- further mounting accessories view page 206 - further accessories for Occhio air from page 226		These and further options can be configured at Occhio Digital Order System (DOS)		further information	- technical data, information on control and mounting options view pages 207–208			

lei/lei 3d mounting accessories

sideways inlet (single- or double-sided)

for all surface-mounted versions,
H 7 mm, ø 76 mm (ø base 88 mm)

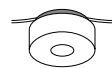

matt white

28,57

canopy with outlet on one or both sides

for all surface-mounted versions,
H 15 mm, ø 88 mm



chrome
glossy white
matt chrome
matt white
matt black

55,46

cable redirection

for sospeso
H 18 mm, ø 15 mm



chrome
matt chrome
matt white
matt black

35,29

cavity box

for mounting of flat luminaires
in hollow ceilings and -walls



3,36

Occhio air module

Bluetooth 4.0 dim module for
phase-cut dimmable luminaires and power supplies,
mounting in cavity or switch box,
max. 4 x 32 W (with Occhio converter,
other converters max. 52 W),
L 40 mm x W 36 mm x H 14 mm

82,35

Occhio air adapter

adapter ring incl. »air« module
for all surface-mounted versions,
mounting under luminaire,
ø 88 mm, H 14 mm

matt white
matt black

110,92

lei 3d mounting options

up

with integrated power supply for
surface mounting, through-wiring possible

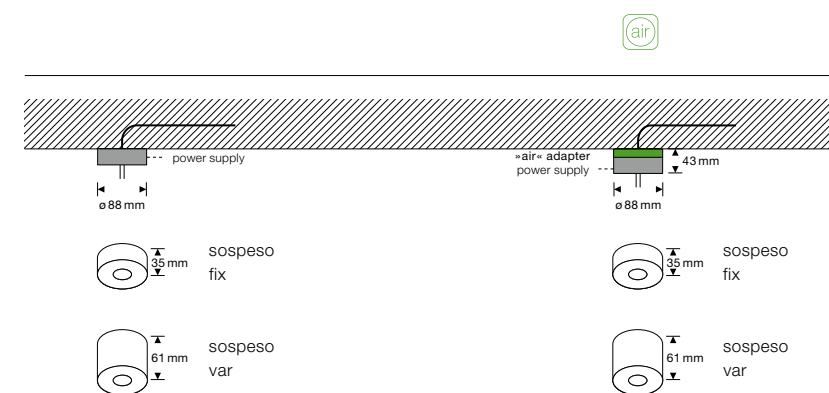

flat

with flat base for cavity box,
remote power supply

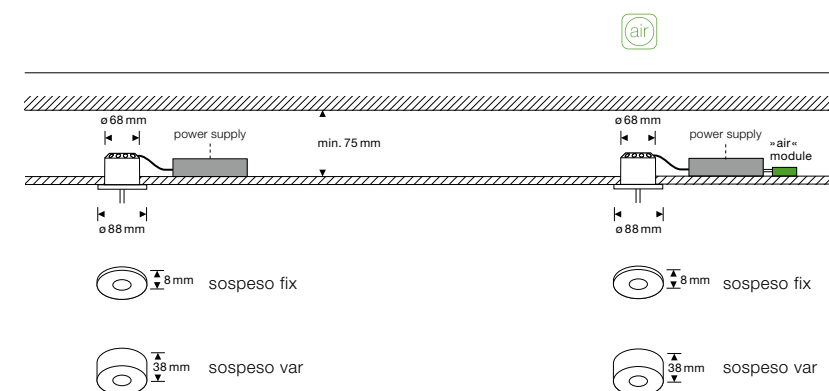

lei 3d technical data and control

version »touch control«

connection	U	230 V AC
average service life	t	> 50.000 h
energy efficiency class	EEK	G

LED		perfect color
color temperature	T	2700 K, 3000 K, 4000 K
Color Rendering Index	CRI	Ra 97
recommended use		residential and public

power	P	perfect color
luminous flux luminaire	φ	9 W
iris		610 lm

control

with Occhio power supply

The Occhio power supply is perfectly matched to these requirements and can be dimmed by trailing-edge phase cut dimmer*. Can not be used in conjunction with »touchless control« or Occhio air.

*Occhio air
powered by
Casambi*

 **Occhio air**
control via Bluetooth – switching, dimming of individual luminaires, groups and scenes.

dimming lei heads

SENSOR OFF
luminaires are dimmed using remote trailing-edge phase cut dimmers*
(except for floor and table luminaires) or controlled with Occhio air (optional)
(switching, dimming).

sensor
on off

SENSOR ON
luminaires can be controlled by sensor button on head
(switching, dimming) – cannot be combined with Occhio air.

* compatible dimmers: occhio.com/dim

E series

Sito

Spherical and sensual, Sito adds high-quality accents. Whether on the building itself, on terraces, on paths or in the garden: Sito offers unique design and quality of light for holistic lighting concepts in outdoor spaces.

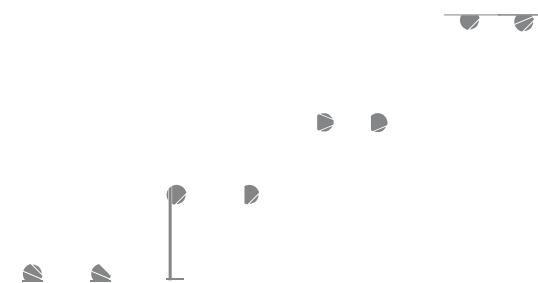

Sito

bollard and floor luminaires



with spherical glass light output 90°–45° 360° rotatable pivotable with flat glass 360° rotatable pivotable light output 45° 65 cm head 45° swivelable

versions

 18W (1100lm)	830,25	805,04
C 80 80°		
 18W (980lm)	845,38	820,17
S 80 80° soft edge		
 18W (870lm)	853,78	828,57
S 40 40° Fresnel lens		

versions

18W (1100lm)		922,69
	C 80 80°	
 18W (980lm)		937,82
	S 80 80° soft edge	
 18W (870lm)		946,22
	S 40 40° Fresnel lens	

control

features

 **230V light engine 18W**
dimable via trailing-edge phase cut dimmer

Occhio air module 

Bluetooth trailing-edge phase cut dimmer for up to 4 luminaires to be installed in a suitable place in a water-protected housing (plastic)
82,35

 **dust-tight and jet-proof**
(IP 65)

options

lightsource

2700K or 3000K, perfect color CRI97

earth anchor

 for potting in concrete

60,50

earth spike

 mounting in loose ground (only Sito basso)

31,93

surfaces

head/body + base colors

matt white
matt black
glossy white / matt white



further options - further mounting accessories view page 218

These and further options can be configured at **Occhio Digital Order System (DOS)**

further information

- technical data, information on control and mounting options view pages 220–222



verticale

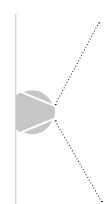

vertical light output

versions



2x9W (1100lm)

838,66

C 80
80°



2x9W (980lm)

853,78

S 80
80°
soft edge

control

features



230V light engine 18W
dimnable via trailing-edge phase cut dimmer

Occhio air module 

Bluetooth trailing-edge phase cut dimmer for up to 4 luminaires
to be installed in a suitable place in a water-protected housing (plastic)
82,35

options

lightsource

2700K or 3000K, perfect color CRI97



giù

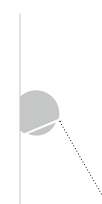

vertical light output

versions



9W (550lm)

652,10

C 80
80°



9W (490lm)

667,23



S 80
80°
soft edge



dust-tight and jet-proof
(IP 65)

surfaces

head colors

matt white 
matt black 
glossy white 

further information

- technical data, information on control
and mounting options view pages 220-222

Sito

ceiling and wall luminaires

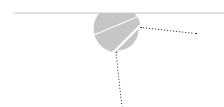

giro

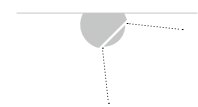

lato

light output 90°–45°

360° rotatable
45° pivotable

versions



18 W (1100lm)

744,54

C 80
80°



18 W (980lm)

759,66

S 80
80°
soft edge



18 W (870lm)

768,07

S 40
40°
Fresnel lens

control

features



230 V light engine 18 W
dimnable via trailing-edge phase cut dimmer

Occhio air module 

Bluetooth trailing-edge phase cut dimmer for up to 4 luminaires
to be installed in a suitable place in a water-protected housing (plastic)
82,35

versions



18 W (1100lm)

652,10

C 80
80°



18 W (980lm)

667,23

S 80
80°
soft edge



18 W (870lm)

675,63

S 40
40°
Fresnel lens

 dust-tight and jet-proof
(IP 65)



options

lightsource

2700 K or 3000 K, perfect color CRI 97

surfaces

head colors

matt white 
matt black 
glossy white 

further information

- technical data, information on control
and mounting options view pages 220–222

Sito mounting options

ground anchor

for potting in concrete,
Sito palo and Sito basso

height: 400 mm
diameter: 95 mm

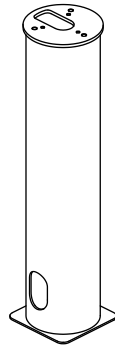

60,50

earth spike

mounting in loose ground
(e. g. earth, gravel),
Sito basso

height: 267 mm
diameter: 60 mm



31,93

Can be configured at **Occhio Digital Order System (DOS)**

Sito mounting options

basso
head: ø 130 mm, H 124 mm



45° swivel range
360° rotatable



Occhio air module optional

solid floor with 230 V connection

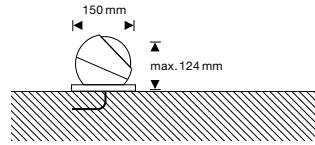

optional: ground anchor for potting in concrete

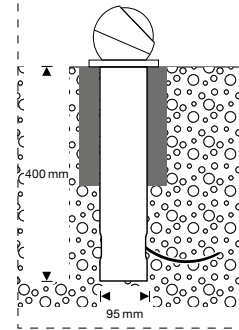

optional: earth spike mounting in loose ground

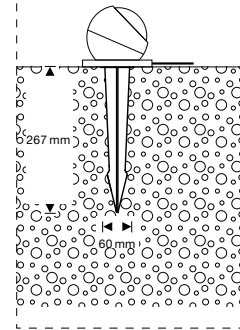

palo
head: ø 130 mm, H 650 mm

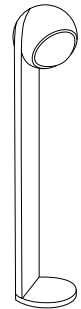

head je 45° rotatable



Occhio air module optional

solid floor with 230 V connection

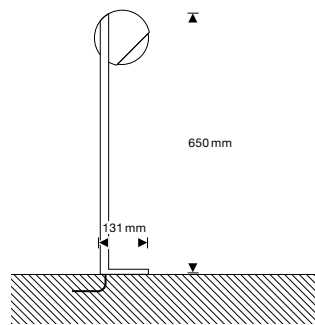

optional: ground anchor for potting in concrete

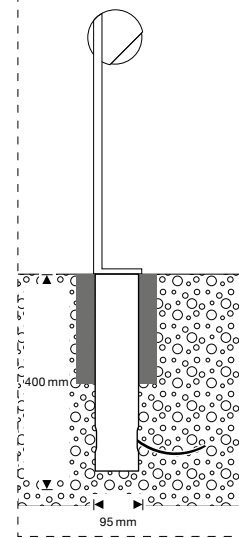

verticale
head: ø 130 mm, L 113 mm



Occhio air module optional

solid wall with 230 V connection

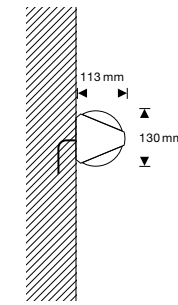

giù
head: ø 130 mm, L 113 mm



Occhio air module optional

solid wall with 230 V connection

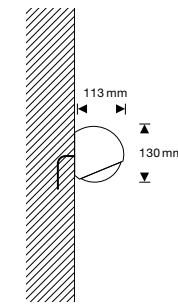

giro
head: ø 130 mm, L 110 mm



45° swivel range
360° rotatable



Occhio air module optional

solid ceiling with 230 V connection

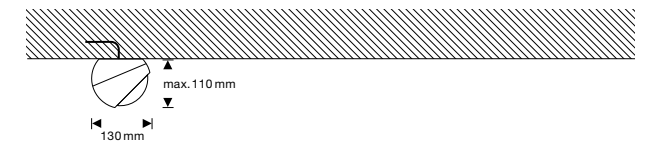

lato
head: ø 130 mm, L 99 mm



Occhio air module optional

solid wall with 230 V connection

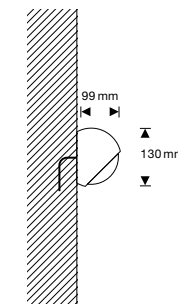

Sito technical data and control



Occhio VOLT light engine

connection	U	230V AC/50Hz
average service life	t	>40.000h
energy efficiency class	EEK	G
safety class		IP 65 (dust-tight and jet proof)

LED		perfect color
color temperature	T	2700K, 3000K
Color Rendering Index	CRI	Ra 97
recommended use		outdoor area for living and object

		P	perfect color		
			9W	2 x 9W	18W
power					
luminous flux luminaire		φ			
Sito					
verticale	C 80			1100lm	
	S 80			980lm	
gio	C 80		550lm		
	S 80		490lm		
lato, giro,	C 80				1100lm
basso, palo	S 80				980lm
	S 40				870lm

control

Sito luminaires can be dimmed via trailing-edge phase cut*.
List of compatible dimmer see below occhio.com/dim.



Occhio air
control via Bluetooth – switching, dimming of individual luminaires, groups and scenes.

Occhio air
powered by
Casambi











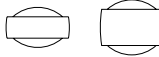

*compatible dimmers: occhio.com/dim

Occhio air

The new simplicity of staging. Whether switching, dimming, »fading« or creating complete light scenarios and group luminaires – with Occhio air light can now be controlled via Bluetooth.

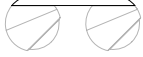

Occhio air

Occhio air controller				
for all luminaires Bluetooth 4.0. remote control for Occhio air, set up via the Occhio air app. L 80 mm x W 80 mm x H 12 mm		matt white/glossy white matt black/glossy black matt white/matt chrome matt black/matt chrome	208,40	
wall mount for Occhio air controller				
for all luminaires mounting via self-adhesive tape, screws or installed on wall box		matt white matt black	26,89	
Occhio air app				
for all luminaires app for operating Occhio air, requires iOS 8.2, Android 4.4 or later, available in the App Store or Google Play Store			free of charge	
Mito »air« box				
for Mito/Mito linear Bluetooth control integrated into cover/canopy, features controllable via Occhio air app or »air« controller (optional), no external dimming				surcharge 82,35
for Mito sospeso due				surcharge 164,71
Sento »air« head				
for Sento/Sento sospeso Bluetooth control integrated into the luminaire head, features controllable via Occhio air app or »air« controller (optional), no external dimming				surcharge 82,35
Occhio air module				
for Più, io spotlights, io 3d, lui spotlights, lui 3d, lei 3d Bluetooth 4.0 dimming module for phase-cut dimmable spotlights and ballasts, mounting in cavity box or wall switch box max. 4 x 32 W L 40 mm x W 36 mm x H 14 mm				82,35
Occhio air adapter				
for Più alto 3d, io 3d, lui 3d, lei 3d adapter ring incl. »air« module, mounting under surface-mounted spacing box ø 88 mm, H 14 mm		matt white matt black		110,92
for Più alto adapter ring incl. »air« module, mounting under surface-mounted spacing box ø 83 mm, H 14 mm		matt white matt black		110,92
for Più alto v adapter ring incl. »air« module, mounting under surface-mounted spacing box ø 83 mm, H 14 mm		matt white matt black		110,92
for lui volto, lui alto v adapter ring incl. »air« module, mounting under surface-mounted spacing box ø 95 mm, H 10 mm		matt white matt black		110,92
for io verticale adapter ring incl. »air« module, mounting under luminaire, ø 82 mm, H 14 mm		matt white matt black		110,92
for io giro, io alto v adapter ring incl. »air« module, mounting under luminaire, ø 77 mm, H 10 mm		matt white matt black		110,92
for io giro doppio adapter ring incl. »air« module, mounting under luminaire, L 196 mm x W 51 mm x H 7 mm		matt white matt black		110,92

Notes

Occhio

Occhio GmbH
Wiener Platz 7
81667 München
Germany
Fon +49-89-44 77 86 80
Fax +49-89-44 77 86 39
info@occhio.com

occhio.com

price overview

English (Euro excl. VAT)

2023|11

Subject to errors and technical change.

All prices are recommended retail

prices by Occhio GmbH.

Product overview valid until further notice.