

io pico flat Datenblatt

LED Decken- /Wandstrahler mit kugelförmigem Kopf und Linsenoptik, Version mit flachem Fuß für Montage auf Hohlraum- oder Deckendose, Stromversorgung mit externer Spannungsquelle (Konverter). Frei beweglich durch Occhio 3d-Kinematik mit zwei im Winkel von 45° zueinander stehenden Drehachsen, Bedienung über wärmeentkoppelte Grip-pads. Kopf für Wartungszwecke abnehmbar, LED wechselbar. Leistung 18W oder 13W (vorwählbar), dimmbar bauseits über dimmbares Vorschaltgerät oder per Gestensteuerung über Touchless-Sensor (deaktivierbar). Lichtwirkung über optionale inserts veränderbar, dichroitische Farbfilter zusätzlich einsetzbar. Oberflächenkombinationen von Kopf, Pads, Arm und Fuß frei konfigurierbar, Pads wechselbar.

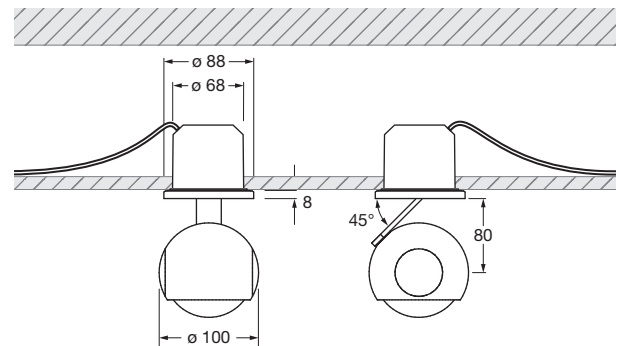

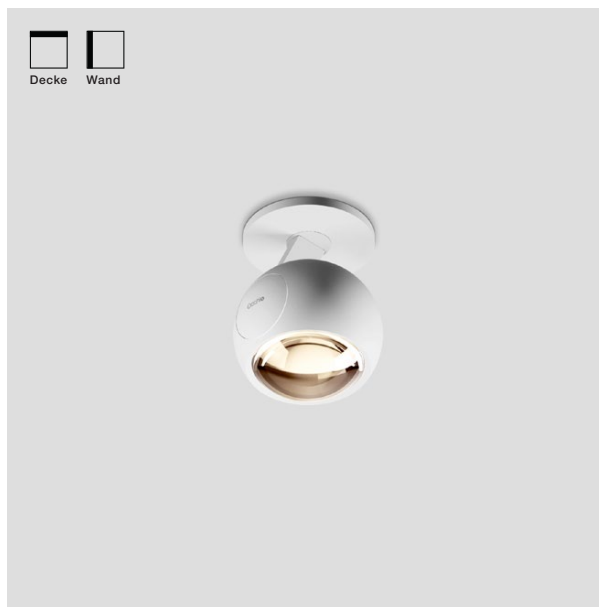

















Maße in mm

technische Daten io pico flat

Eigenschaften	Material	Aluminium, Zink verchromt oder lackiert, optischer Kunststoff, Glas
	Drehbereich head	360°
	Drehbereich body	360° (mit Anschlag)
	Gewicht	1,0 kg
Oberfläche	head	gold matt, rose gold, bronze, chrom glanz, chrom matt, weiß glanz, weiß matt, schwarz matt, phantom, black phantom
	pads	rose gold, bronze, chrom glanz, chrom matt, weiß glanz, weiß matt, schwarz matt
	body	chrom glanz, chrom matt, weiß matt, schwarz matt
	base	chrom glanz, chrom matt, weiß glanz, weiß matt, schwarz matt
Occhio LED	mittlere Lebensdauer	> 50.000 Std.
	Energieeffizienzklasse (Lichtausbeute)	G (63 lm / W)
	Leistung	LED 18 W (inkl. Occhio Vorschaltgerät 22 W, standby < 0,5 W) / LED 13 W (inkl. Occhio Vorschaltgerät 15 W, standby < 0,5 W)
	Farbwiedergabeindex	perfect color; CRI Ra 97 high flux; CRI Ra 85
Farbtemperatur (Farbkonsistenz)	2700 K, 3000 K (2-step)	3000 K, 3500 K, 4000 K (2-step)
Elektrik	Dimmung	über im Kopf integrierten touchless Sensor oder extern per Phasenabschnittdimmer*, Taster, 1–10V, DALI
	Powerfaktor Netzteil (cos φ1)	0,9
	Flimmer / Stroboskop-Effekt	1 (PstLM) / 0,9 (SVM)
	Vorschaltgerät	extern, Betrieb über Konstantspannungsquelle 42...48V DC / min. 22W
	zulässige Betriebsbedingung	max. 30°C nur im Innenbereich betreiben

* Liste kompatibler Dimmer: www.occhio.com/dim

io pico flat Übersicht inserts

io head				
satiniertes Glas				
soft edge Glas				
Fresnel-Linse				
Farbfilter (optional, Lichtleistung max. 13 W)				
Linse				
				
	io C	io C mit soft edge Glas	io C mit satiniertem Glas	io C mit Fresnel-Linse

io pico flat Lichtwirkungen

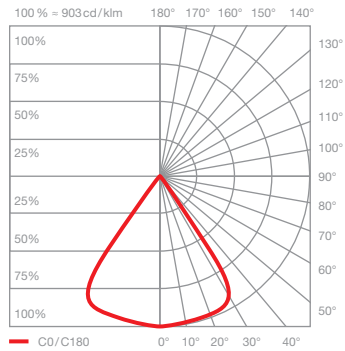
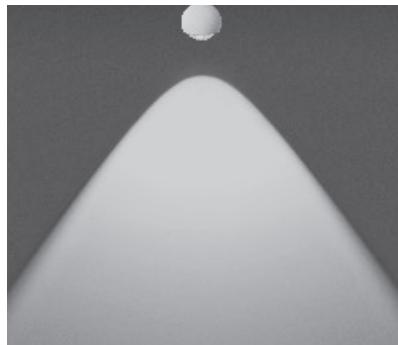

io C gerichtetes Licht (ca. 80°)

inserts:	Linse		
Lichtstrom:	perfect color	18 W	1170 lm
	high flux	18 W	1610 lm
	perfect color	13 W	800 lm
	high flux	13 W	1170 lm

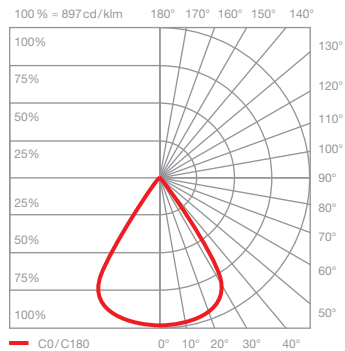
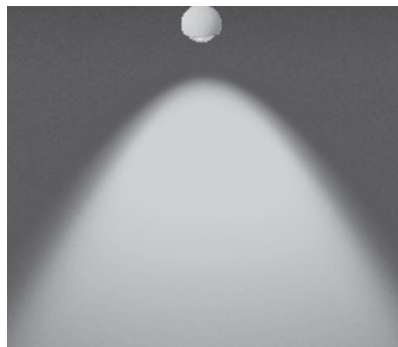

io C mit soft edge Glas gerichtetes Licht mit weichen Konturen des Lichtkegels (ca. 80°)

inserts:	Linse soft edge Glas		
Lichtstrom:	perfect color	18 W	1070 lm
	high flux	18 W	1470 lm
	perfect color	13 W	740 lm
	high flux	13 W	1070 lm

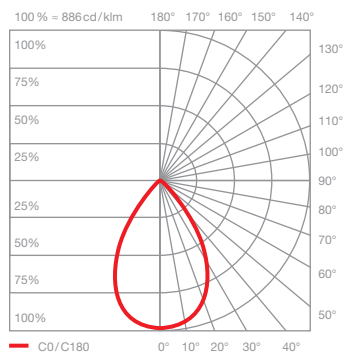
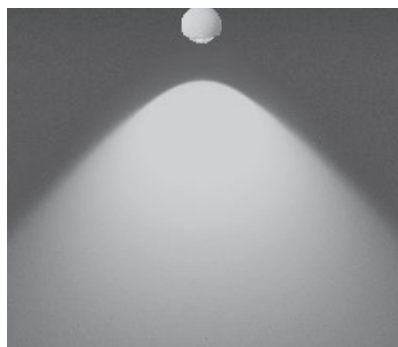

io C mit satiniertem Glas gestreutes Licht mit sanfter Aufweitung des Lichtkegels (ca. 100°)

inserts:	Linse satiniertes Glas		
Lichtstrom:	perfect color	18 W	910 lm
	high flux	18 W	1250 lm
	perfect color	13 W	630 lm
	high flux	13 W	910 lm

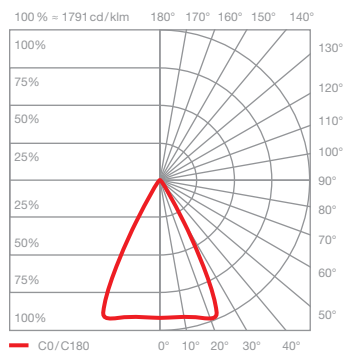
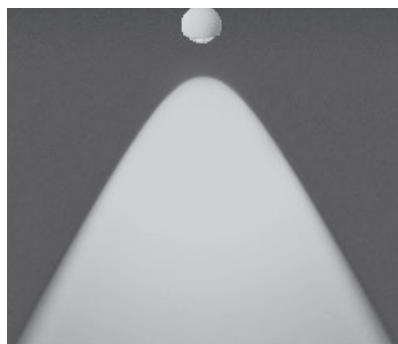

io C mit Fresnel-Linse gebündeltes Licht Lichtkegel ca. 60°

inserts:	Linse Fresnel-Linse		
Lichtstrom:	perfect color	18 W	990 lm
	high flux	18 W	1360 lm
	perfect color	13 W	680 lm
	high flux	13 W	990 lm