

## Divo letto mains voltage halogen

Wall luminaire - modular system consisting of body and head

Thanks to its unique modularity the Occhio head-body system delivers impressive lighting solutions for your room. For different lighting effects diverse, turnable reflector heads are available, which can be easily substituted at any time thanks to a simple plug-in mechanism. The diverse wall and ceiling boxes allow for all recessed and surface mounting options.

Wall luminaire Occhio Divo letto consisting of

- body Occhio letto - different length and surfaces
- head Occhio Divo - different lighting effects and surfaces
- Occhio accessories - different mounting options and surfaces

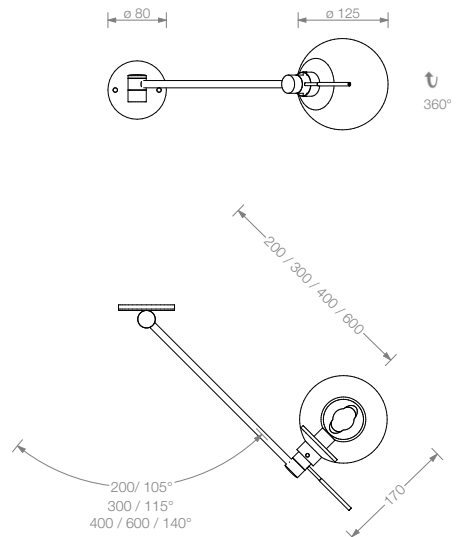
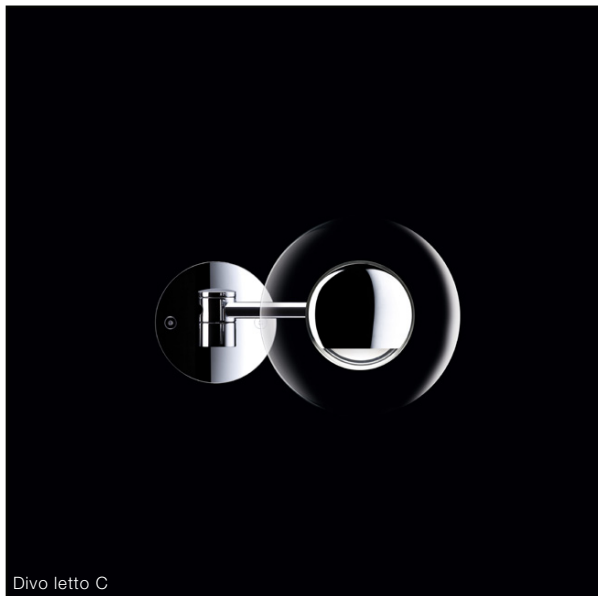

### material

aluminium, brass, steel, glass

### surface

head: chrome, matt chrome  
body: chrome, matt chrome

### length / travel

20 cm / 105°, 30 cm / 115°, 40 cm / 140° und 60 cm / 140°

### recommended lighting effect

B, C, E see p.2 cutsheet

### light source

mains voltage halogen, operating voltage 230V  
60 / 70 W, B15d Eco,  
energy efficiency grade D, lifetime 2.000 h

### luminous flux (bulb)

60 W / 980 lm, 70 W / 1180 lm

### color temperature / color rendering

2900 K / CRI 100

### weight

body and reflector head max. 1,2 kg

### mounting accessories

for surface or recessed mounting, see p.3 cutsheet

## Divo letto recommended lighting effect

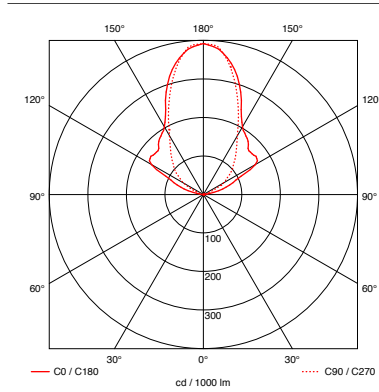

**Divo B**  
reflector head for light with wide radiation to one side

with satinised glass, the light output varies compared to the illustrations shown

**efficiency of reflector head**  
clear glass 69%  
satinised glass 66%

**material / surface**  
clear or satinised, heat-resistant glass  
reflector aluminium  
fixture matt chrome or chrome

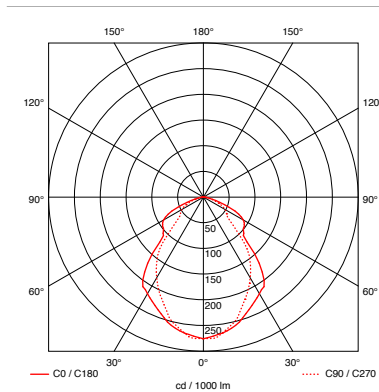

**Divo C**  
reflector head for light with narrow radiation to one side

with satinised glass, the light output varies compared to the illustrations shown

**efficiency of reflector head**  
clear glass 54%  
satinised glass 52%

**material / surface**  
clear or satinised, heat-resistant glass  
reflector aluminium  
fixture matt chrome or chrome

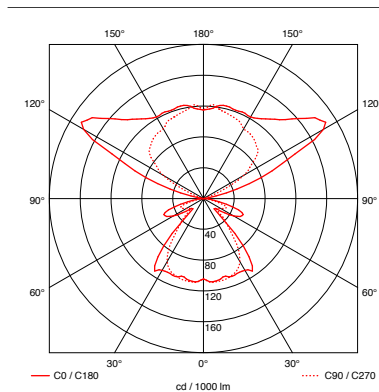
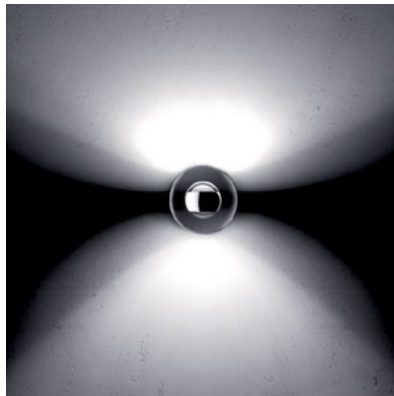

**Divo E**  
reflector head for light with wide radiation to one and narrow radiation to the other side



with satinised glass the light output varies compared to the illustrations shown

**efficiency of reflector head**  
clear glass 79%  
satinised glass 77%

**material / surface**  
clear or satinised, heat-resistant glass  
reflector aluminium  
fixture matt chrome or chrome

## Divo letto Item numbers







Item number  
\_matt chrome M  
\_chrome C

letto				
		max. 70W mains voltage halogen B15d	20 cm	8B 11 00 _ L/R
	L		30 cm	8B 12 00 _ L/R
	R		40 cm	8B 13 00 _ L/R
			60 cm	8B 14 00 _ L/R



Divo B				
		clear glass		8K 00 B1 M
		satinised glass		8K 00 B1 C
Divo C				
		clear glass		8K 00 C1 M
		satinised glass		8K 00 C1 C
Divo E				
		clear glass		8K 00 E1 M
		satinised glass		8K 00 E1 C
				8K 00 E2 M
				8K 00 E2 C

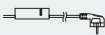

flat box				
		for plastering or wall / ceiling box h 8 mm, ø 80 mm		8Z 00 00 _
spacing box				
		for surface mounting h 22 mm, ø 80 mm		8Z 01 00 _
		with hole for external cable supply h 22 mm, ø 80 mm		8Z 03 00 _
cabledimmer				
		with transparent connector cable, cable length 150 / 150 cm, for use with spacing box with hole for external cable supply		8B 00 00 T