

Sento verticale up pro scheda tecnica

Lampada da soffitto a LED con base alta che include un driver Occhio per il montaggio su una parete piena, collegamento a 230 V. Il sistema modulare testa / corpo con LED consente di combinare liberamente finiture differenti per testa, corpo e base. Testa rimovibile per la configurazione e la manutenzione, LED sostituibile (2700 K / 3000 K / 4000 K) Le teste sono disponibili con emissione luminosa su un unico lato o su due lati, emissione luminosa 26 W.

L'effetto di illuminazione può essere modificato inserendo degli inserti opzionali, è possibile anche utilizzare dei filtri di colore dicroici. Regolazione mediante perno in carbonio disaccoppiato a caldo. La testa può essere fissata per evitare la torsione.

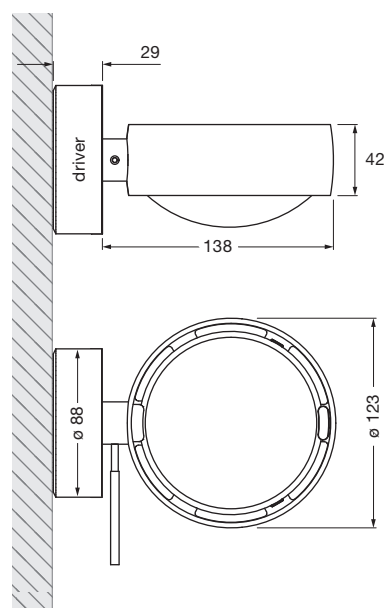













































dimensioni in mm

dati tecnici Sento verticale up pro

proprietà	materiale	alluminio, acciaio cromato, verniciato o anodizzato, plastica, vetro, plastica ottica
	lunghezza	138 mm inclusa la testa
	rotazione testa	360°
	peso	1,4 kg
superficie	testa	oro opaco, oro rosa, bronzo, cromato brillante, cromato opaco, bianco lucido, bianco opaco, nero opaco, phantom, black phantom
	corpo	bianco opaco, nero opaco, cromato brillante, cromato opaco
	base	cromato brillante, bianco lucido, cromato opaco, bianco opaco, nero opaco
Occhio LED	durata media	> 50.000 ore
	classe di efficienza energetica (efficacia luminosa)	G (testa lato unico 66 lm/W, testa due lati 73 lm/W)
	potenza per un lato / due lati	LED 26 W max. 700 mA (> 36 CC) / max. 2 x 350 mA (> 36 CC)
	indice di resa cromatica	colore perfetto; CRI Ra 97 flusso alto; CRI Ra 85
	temperatura del colore	2700, 3000 K, 4000 K 3000, 3500, 4000 K
elettricità	attenuazione	tramite dimmer a taglio di fase discendente*
	alimentatore	integrato, per l'uso con 230 V CA
	condizioni operative consentite	max. 30 °C solo per uso interno

* Per un elenco dei dimmer compatibili, vedere www.occhio.com/dim_en

Sento verticale up pro panoramica degli inserti

testa monodirezionale				
lente per faretto				
vetro satinato (opzionale)				
vetro con bordo levigato (opzionale)				
lente di fresnel				
filtro di colore (opzionale, potenza della sorgente di luce max. 18 W)				
vetro diffusore				
lente				
				
	Sento B	Sento C	Sento S30	Sento S40
lente				
vetro diffusore				
filtro di colore (opzionale, potenza della sorgente di luce max. 18 W)				
vetro con bordo levigato (opzionale)				
vetro satinato (opzionale)				
testa biemissione				
vetro satinato (opzionale)				
vetro con bordo levigato (opzionale)				
filtro di colore (opzionale, potenza della sorgente di luce max. 18 W)				
vetro diffusore				
lente				
				
		Sento A	Sento D	Sento E

Sento verticale up pro effetti di illuminazione

 testa lato unico

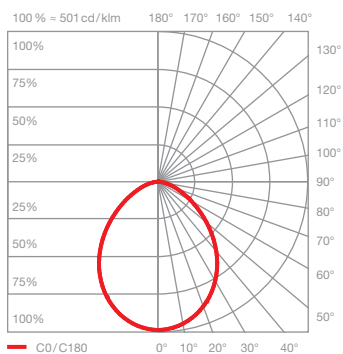
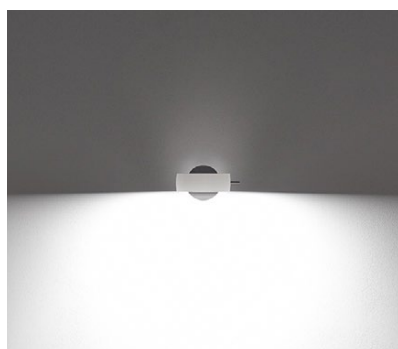

Sento B

luce diffusa

inserto: vetro diffusore

flusso luminoso: perfect color 26 W 1370lm
 high flux 26 W 1870lm

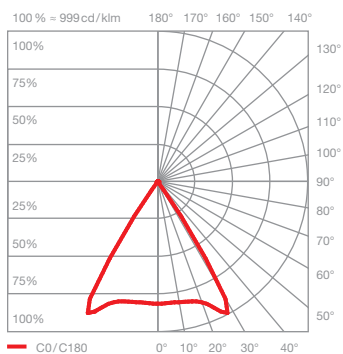

Sento C

luce diretta
inclinazione del fascio ca. 80°

inserto: lente
flusso luminoso: perfect color 26 W 1570lm
 high flux 26 W 2150lm

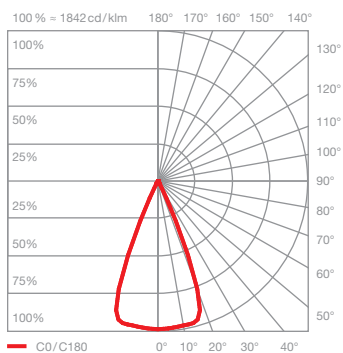
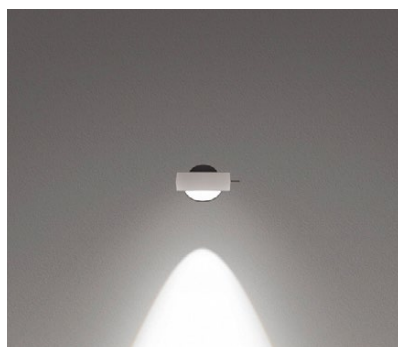

Sento S40

luce diretta
inclinazione del fascio ca. 40°

inserto: lente per faretto, lente
 vetro con bordo levigato

flusso luminoso: perfect color 26 W 1560lm
 high flux 26 W 2130lm

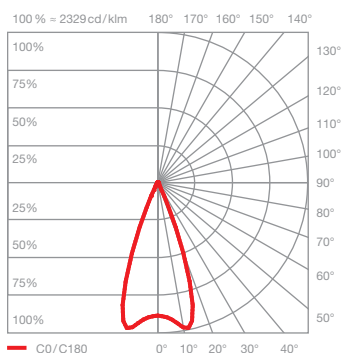

Sento S30

luce diretta
inclinazione del fascio ca. 30°

inserto: lente per faretto, lente
 lente di fresnel

flusso luminoso: perfect color 26 W 1530lm
 high flux 26 W 2080lm

Sento verticale up pro effetti di illuminazione

 testa due lati

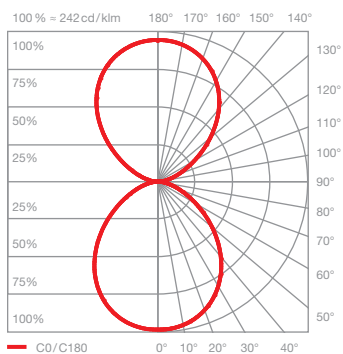
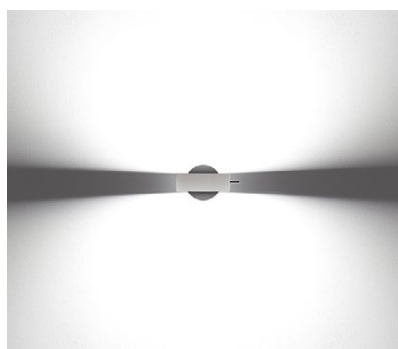

Sento A

luce diffusa in entrambe le direzioni

inserto: vetro diffusore
vetro diffusore

flusso luminoso: perfect color 26 W 1500lm
high flux 26 W 2040lm

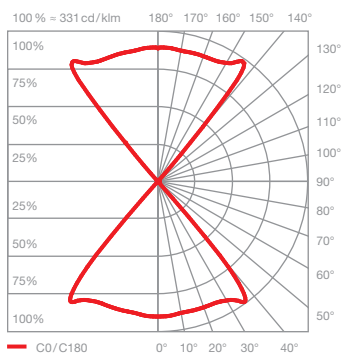

Sento D

luce diretta in entrambe le direzioni
inclinazione del fascio ca. 80°

inserto: lente
lente

flusso luminoso: perfect color 26 W 1750lm
high flux 26 W 2390lm

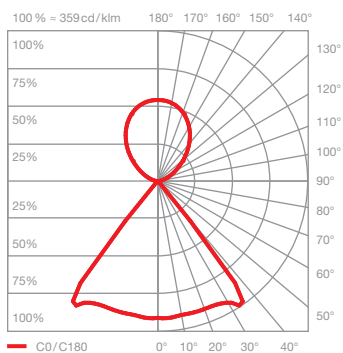
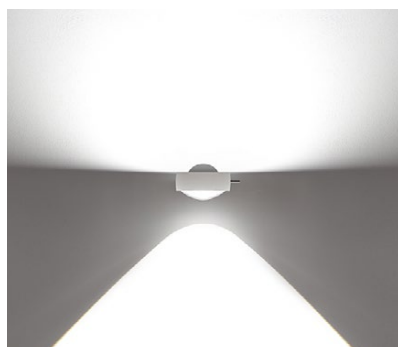

Sento E

luce diffusa verso l'alto
luce diretta verso il basso
inclinazione del fascio ca. 80°

inserto: vetro diffusore
lente

flusso luminoso: perfect color 26 W 1620lm
high flux 26 W 2200lm