

## Sento verticale flat pro scheda tecnica

Lampada da parete a LED con base piatta per il montaggio su rosone. Collegamento a una sorgente di tensione costante remota (driver). Il sistema modulare testa / corpo con LED consente di combinare liberamente finiture differenti per testa, corpo e base. Testa rimovibile per la configurazione e la manutenzione, LED sostituibile. Le teste sono disponibili con emissione luminosa su un unico lato o su due lati, potenza della sorgente di luce 26 W.

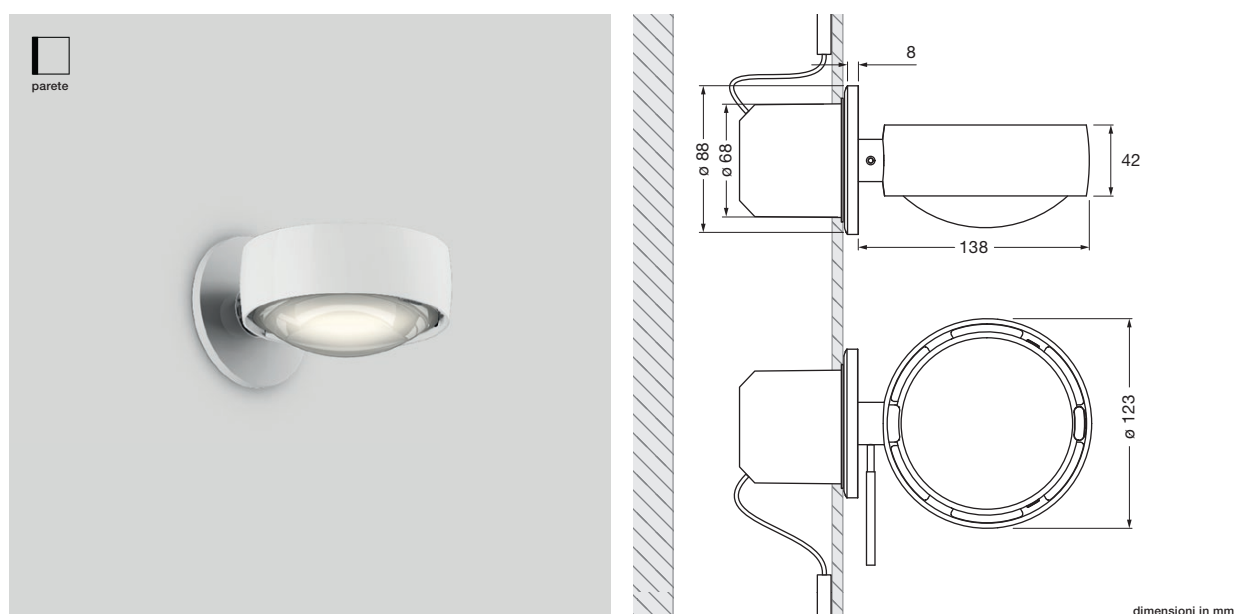











































L'effetto di illuminazione può essere modificato tramite inserti opzionali; è possibile aggiungere filtri di colore dicroici. Regolazione mediante perno in carbonio disaccoppiato a caldo (il fissaggio della testa contro la rotazione è opzionale). Controllabile tramite dimmer esterno (a seconda del tipo di alimentatore).



### dati tecnici Sento verticale flat pro

proprietà	materiale	alluminio, acciaio cromato, verniciato o anodizzato, plastica, vetro, plastica ottica
	lunghezza	138 mm inclusa la testa
	rotazione testa	360°
	peso	1,2 kg
superficie	testa	oro opaco, oro rosa, bronzo, cromato brillante, cromato opaco, bianco lucido, bianco opaco, nero opaco, phantom, black phantom
	corpo	bianco opaco, nero opaco, cromato brillante, cromato opaco
	base	cromato brillante, bianco lucido, cromato opaco, bianco opaco, nero opaco
Occhio LED	durata media	> 50.000 ore
	classe di efficienza energetica (efficacia luminosa)	G (testa lato unico 66 lm/W, testa due lati 73 lm/W)
	potenza per un lato / due lati	LED 26 W max. 700 mA (> 36 CC) / max. 2 x 350 mA (> 36 CC)
	indice di resa cromatica	colore perfetto; CRI Ra 97      flusso alto; CRI Ra 85
	temperatura del colore	2700, 3000 K      3000, 3500, 4000 K
elettricità	attenuazione	con dimmer a taglio di fase discendente, pulsante, DALI o 1-10 V (a seconda del driver)
	alimentatore	remoto, alimentato da una sorgente di tensione costante max. 700 mA / > 36 V CC
	condizioni operative consentite	max. 30 °C solo per uso interno

## Sento verticale flat pro panoramica degli inserti

testa monodirezionale				
lente per faretto				
vetro satinato (opzionale)				
vetro con bordo levigato (opzionale)				
lente di fresnel				
filtro di colore (opzionale, potenza della sorgente di luce max. 18 W)				
vetro diffusore				
lente				
				
	<b>Sento B</b>	<b>Sento C</b>	<b>Sento S30</b>	<b>Sento S40</b>
lente				
vetro diffusore				
filtro di colore (opzionale, potenza della sorgente di luce max. 18 W)				
vetro con bordo levigato (opzionale)				
vetro satinato (opzionale)				
testa biemissione				
vetro satinato (opzionale)				
vetro con bordo levigato (opzionale)				
filtro di colore (opzionale, potenza della sorgente di luce max. 18 W)				
vetro diffusore				
lente				
				
		<b>Sento A</b>	<b>Sento D</b>	<b>Sento E</b>

## Sento verticale flat pro effetti di illuminazione

 testa lato unico

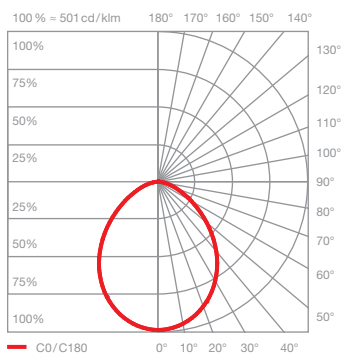
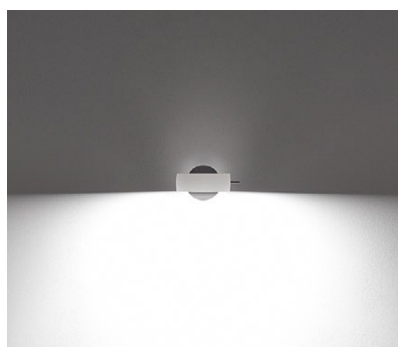

### Sento B

luce diffusa

inserto: vetro diffusore

flusso luminoso: perfect color 26 W 1370lm  
high flux 26 W 1870lm

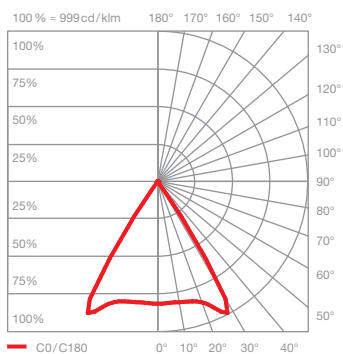

### Sento C

luce diretta

inclinazione del fascio ca. 80°

inserto: lente  
flusso luminoso: perfect color 26 W 1570lm  
high flux 26 W 2150lm

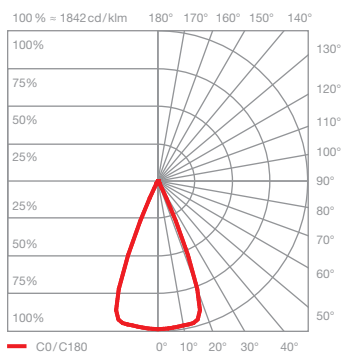
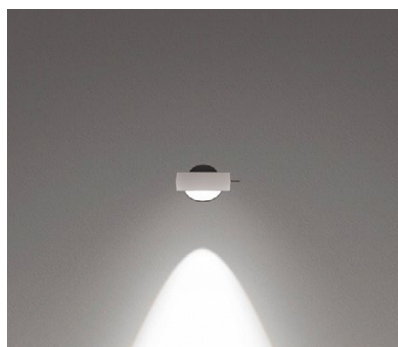

### Sento S40

luce diretta

inclinazione del fascio ca. 40°

inserto: lente per faretto, lente  
vetro con bordo levigato

flusso luminoso: perfect color 26 W 1560lm  
high flux 26 W 2130lm

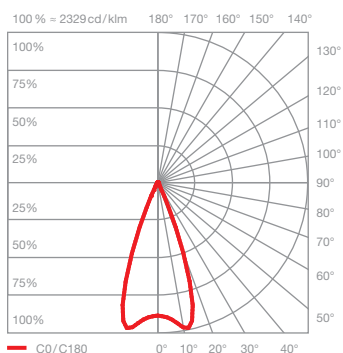

### Sento S30

luce diretta

inclinazione del fascio ca. 30°

inserto: lente per faretto, lente  
lente di fresnel

flusso luminoso: perfect color 26 W 1530lm  
high flux 26 W 2080lm

## Sento verticale flat pro effetti di illuminazione

 testa due lati

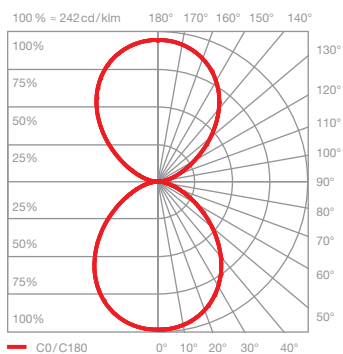
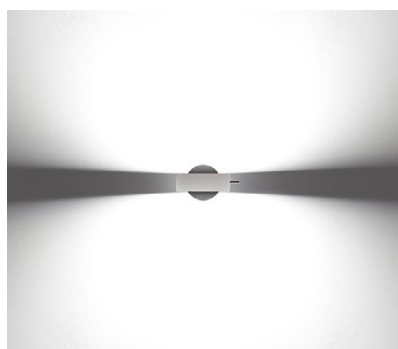

### Sento A

luce diffusa in entrambe le direzioni

inserto: vetro diffusore  
vetro diffusore

flusso luminoso: perfect color 26 W 1500lm  
high flux 26 W 2040lm

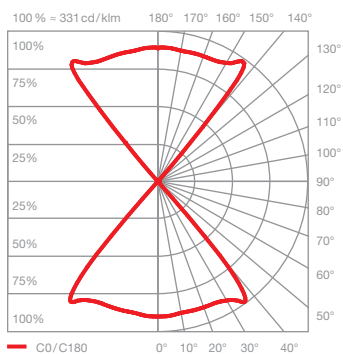

### Sento D

luce diretta in entrambe le direzioni  
inclinazione del fascio ca. 80°

inserto: lente  
lente

flusso luminoso: perfect color 26 W 1750lm  
high flux 26 W 2390lm

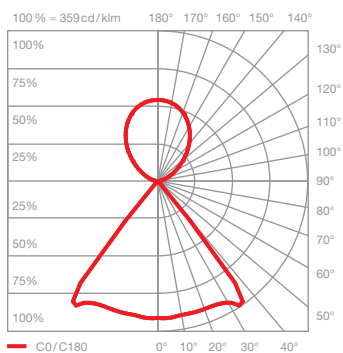
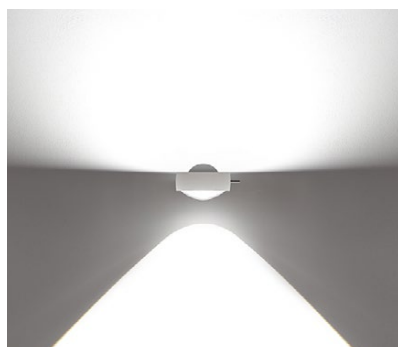

### Sento E

luce diffusa verso l'alto  
luce diretta verso il basso  
inclinazione del fascio ca. 80°

inserto: vetro diffusore  
lente

flusso luminoso: perfect color 26 W 1620lm  
high flux 26 W 2200lm