

Sento soffitto due flat scheda tecnica

Lampada da soffitto a LED con base piatta per il montaggio su rosone. Collegamento a una sorgente di tensione costante remota (convertitore). Il sistema modulare testa / corpo con LED consente di combinare liberamente finiture differenti per testa, corpo e base. Testa rimovibile per la configurazione e la manutenzione, LED sostituibile. Le teste sono disponibili con emissione luminosa su un unico lato o su due lati, potenza della sorgente di luce 18 W o 26 W. L'effetto di illuminazione può essere modificato tramite inserti opzionali; è possibile aggiungere filtri di colore diecrici. Regolazione mediante perno in carbonio disaccoppiato a caldo (il fissaggio della testa contro la rotazione è opzionale). Controllabile tramite dimmer esterno (a seconda del tipo di alimentatore) o via »touchless control«, ovvero controllo gestuale sulla testa.

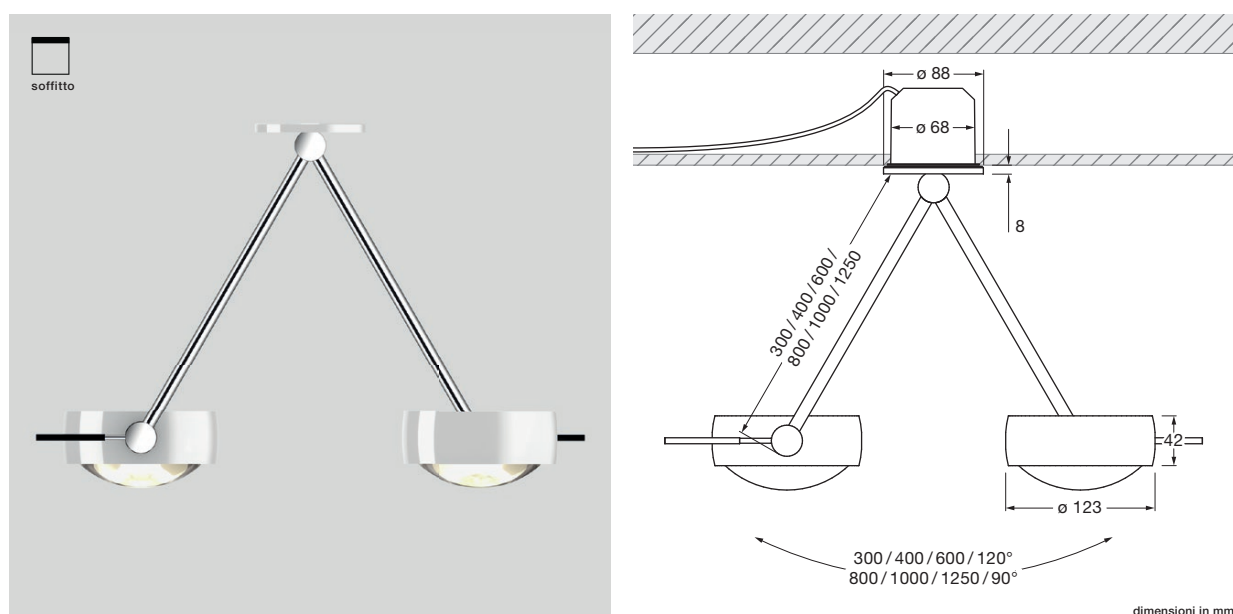













































dati tecnici Sento soffitto due flat

proprietà	materiale	alluminio, acciaio cromato, verniciato o anodizzato, plastica, vetro, plastica ottica	
	lunghezza	300 / 400 / 600 / 800 / 1000 / 1250 mm	
	gamma di rotazione, rotazione testa	300, 400, 600 mm 120° / 800, 1000, 1250 mm 90°, 360°	
	peso	3,1 kg (300, 400, 600, 800) / 3,5 kg (1000, 1250)	
superficie	testa	oro opaco, oro rosa, bronzo, cromato brillante, cromato opaco, bianco lucido, bianco opaco, nero opaco, phantom, black phantom	
	corpo	bianco opaco, nero opaco, cromato brillante, cromato opaco	
	base	cromato brillante, bianco lucido, cromato opaco, bianco opaco	
Occhio LED	durata media	> 50.000 ore	
	classe di efficienza energetica (efficacia luminosa)	G (testa lato unico 62 lm/W, testa due lati 69 lm/W)	
	alimentazione	2 x LED 26 W (incl. alimentatore Occhio circa 30 W, modo stand-by < 0,5 W) / 2 x LED 18 W (incl. alimentatore Occhio circa 22 W, modo stand-by < 0,5 W)	
	indice di resa cromatica	colore perfetto; CRI Ra 97	flusso alto; CRI Ra 85
	temperatura del colore (coerenza dei colori)	2700, 3000 K (2-step)	3000, 3500, 4000 K (2-step)
elettricità	attenuazione	»touchless control« e Occhio air (opzionale) o con un dimmer a taglio di fase discendente* (a seconda del driver)	
	alimentatore	remoto, alimentato da una sorgente di tensione costante 48 V CC / min. 30 W per ciascuna testa	
	alimentatore con fattore di potenza (cos φ1)	0,9	
	sfarfallio / dell'effetto stroboscopico	1 (PstLM) / 0,9 (SVM)	
	condizioni operative consentite	max. 30 °C solo per uso interno	

* dimmer a taglio di fase discendente e Occhio air non combinabili



Sento soffitto due flat panoramica degli inserti

testa monodirezionale				
lente per faretto				
vetro satinato (opzionale)				
vetro con bordo levigato (opzionale)				
lente di fresnel				
filtro di colore (opzionale, potenza della sorgente di luce max. 18 W)				
vetro diffusore				
lente				
				
	Sento B	Sento C	Sento S30	Sento S40
lente				
vetro diffusore				
filtro di colore (opzionale, potenza della sorgente di luce max. 18 W)				
vetro con bordo levigato (opzionale)				
vetro satinato (opzionale)				
testa biemissione				
vetro satinato (opzionale)				
vetro con bordo levigato (opzionale)				
filtro di colore (opzionale, potenza della sorgente di luce max. 18 W)				
vetro diffusore				
lente				
				
		Sento A	Sento D	Sento E

Sento soffitto due flat effetti di illuminazione

 testa lato unico

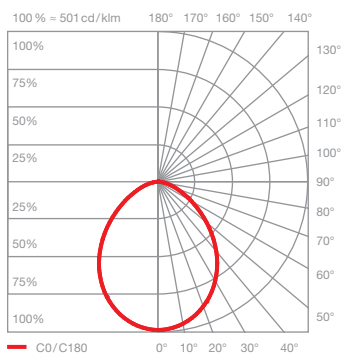
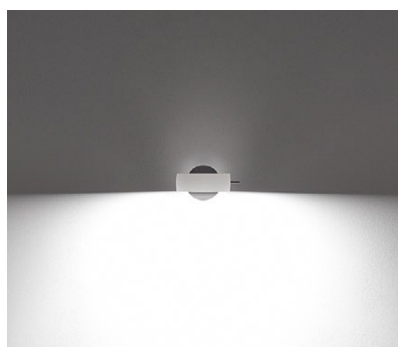

Sento B

luce diffusa

inserto: vetro diffusore

flusso luminoso: perfect color 2 x 26 W 1370lm
high flux 2 x 26 W 1870lm

perfect color 2 x 18 W 1000lm
high flux 2 x 18 W 1370lm

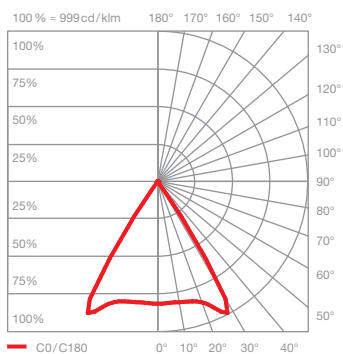

Sento C

luce diretta

inclinazione del fascio ca. 80°

inserto: lente

flusso luminoso: perfect color 2 x 26 W 1570lm
high flux 2 x 26 W 2150lm

perfect color 2 x 18 W 1140lm
high flux 2 x 18 W 1570lm

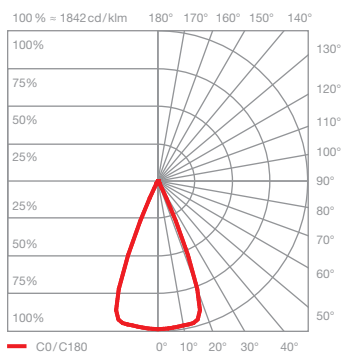
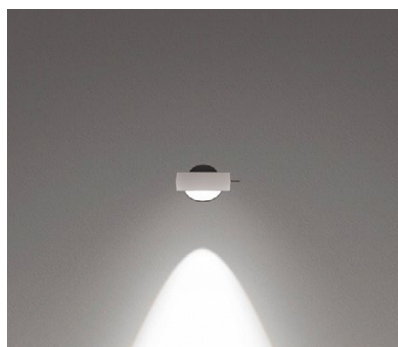

Sento S40

luce diretta

inclinazione del fascio ca. 40°

inserto: lente per faretto, lente
vetro con bordo levigato

flusso luminoso: perfect color 2 x 26 W 1560lm
high flux 2 x 26 W 2130lm

perfect color 2 x 18 W 1130lm
high flux 2 x 18 W 1560lm

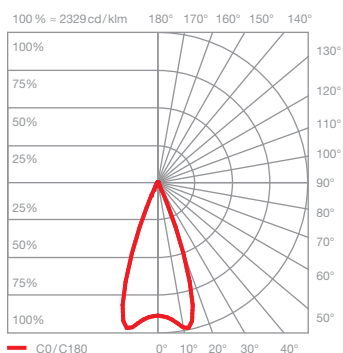

Sento S30

luce diretta

inclinazione del fascio ca. 30°

inserto: lente per faretto, lente
lente di fresnel

flusso luminoso: perfect color 2 x 26 W 1530lm
high flux 2 x 26 W 2080lm

perfect color 2 x 18 W 1110lm
high flux 2 x 18 W 1530lm

Sento soffitto due flat effetti di illuminazione

 testa due lati

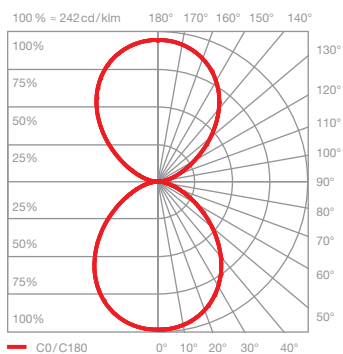
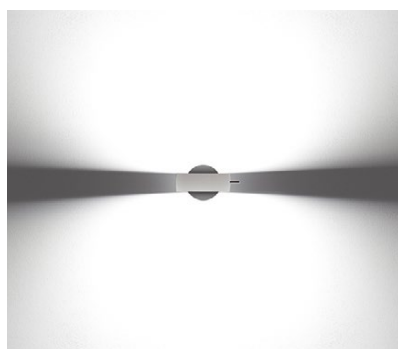

Sento A

luce diffusa in entrambe le direzioni

inserto: vetro diffusore
vetro diffusore

flusso luminoso: perfect color 2 × 26 W 1500 lm
high flux 2 × 26 W 2040 lm

perfect color 2 × 18 W 1090 lm
high flux 2 × 18 W 1500 lm

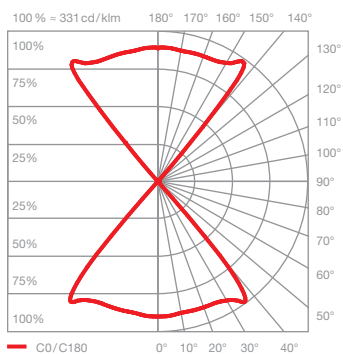

Sento D

luce diretta in entrambe le direzioni
inclinazione del fascio ca. 80°

inserto: lente
lente

flusso luminoso: perfect color 2 × 26 W 1750 lm
high flux 2 × 26 W 2390 lm

perfect color 2 × 18 W 1270 lm
high flux 2 × 18 W 1750 lm

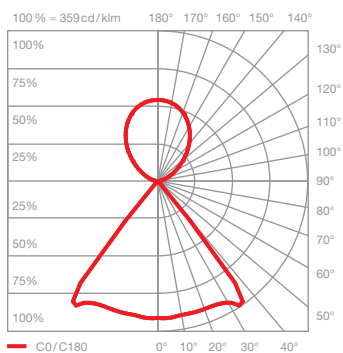
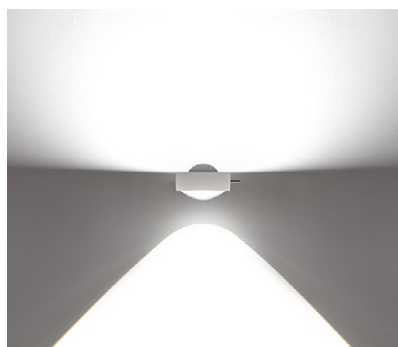

Sento E

luce diffusa verso l'alto
luce diretta verso il basso
inclinazione del fascio ca. 80°

inserto: vetro diffusore
lente

flusso luminoso: perfect color 2 × 26 W 1620 lm
high flux 2 × 26 W 2200 lm

perfect color 2 × 18 W 1170 lm
high flux 2 × 18 W 1620 lm