

Sento parete singolo up scheda tecnica

Lampada da parete a LED con base alta che include un alimentatore (convertitore) per il montaggio su un soffitto o su una parete, collegamento a 230 V. Il sistema modulare testa / corpo con LED consente di combinare liberamente finiture differenti per testa, corpo e base. Testa rimovibile per la configurazione e la manutenzione, LED sostituibile. Le teste sono disponibili con emissione luminosa su un unico lato o su due lati, potenza della sorgente di luce 18 W o 26 W. L'effetto di illuminazione può essere modificato tramite inserti opzionali; è possibile aggiungere filtri di colore dicroici. Regolazione mediante perno in carbonio disaccoppiato a caldo (il fissaggio della testa contro la rotazione è opzionale). Regolabile con un dimmer a taglio di fase discendente esterno o via »touchless control«, ovvero controllo gestuale sulla testa.

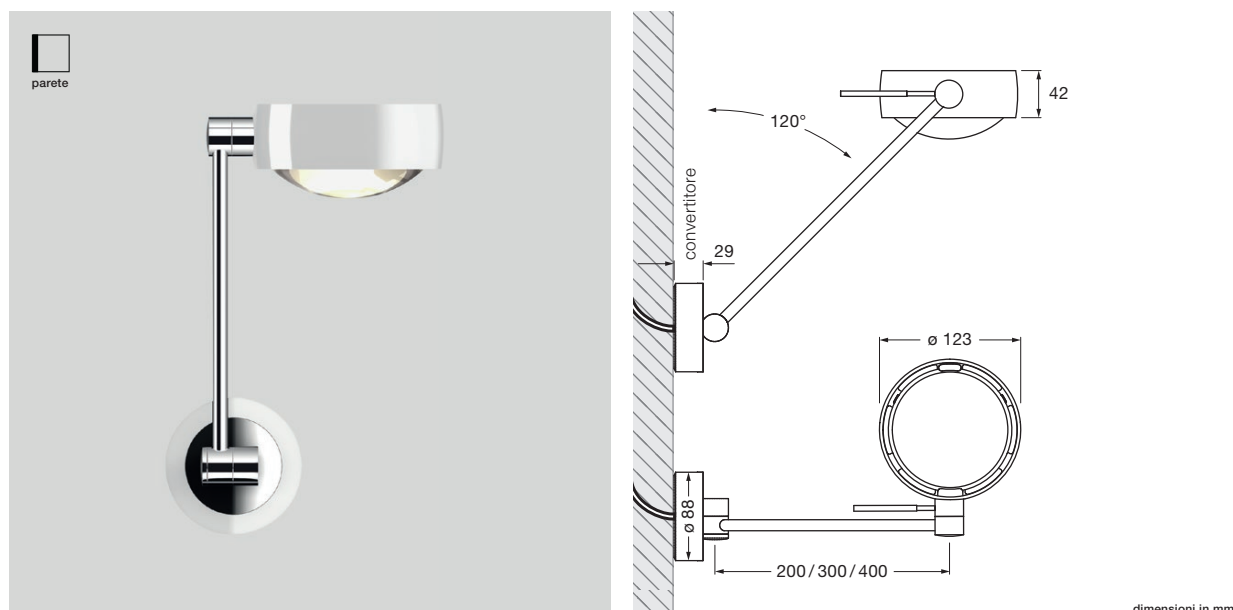













































dati tecnici Sento parete singolo up

proprietà	materiale	alluminio, acciaio cromato, verniciato o anodizzato, plastica, vetro, plastica ottica	
	lunghezza	200 / 300 / 400 mm	
	gamma di rotazione, rotazione testa	120°, 360°	
	peso	1,7 kg	
superficie	testa	oro opaco, oro rosa, bronzo, cromato brillante, cromato opaco, bianco lucido, bianco opaco, nero opaco, phantom, black phantom	
	corpo	bianco opaco, nero opaco, cromato brillante, cromato opaco	
	base	cromato brillante, bianco lucido, cromato opaco, bianco opaco	
Occhio LED	durata media	> 50.000 ore	
	classe di efficienza energetica (efficacia luminosa)	G (testa lato unico 62 lm/W, testa due lati 69 lm/W)	
	alimentazione	LED 26 W (incl. alimentatore Occhio circa 30 W, modo stand-by < 0,5 W) / LED 18 W (incl. alimentatore Occhio circa 22 W, modo stand-by < 0,5 W)	
	indice di resa cromatica	colore perfetto; CRI Ra 97	flusso alto; CRI Ra 85
	temperatura del colore (coerenza dei colori)	2700, 3000 K (2-step)	3000, 3500, 4000 K (2-step)
elettricità	attenuazione	»touchless control« e Occhio air (opzionale) o con un dimmer a taglio di fase discendente* (a seconda del driver)	
	alimentatore	integrato, per l'uso con 230 V CA	
	alimentatore con fattore di potenza (cos φ1)	0,9	
	sfarfallio / dell'effetto stroboscopico	1 (PstLM) / 0,9 (SVM)	
	condizioni operative consentite	max. 30 °C solo per uso interno	

* Per un elenco dei dimmer compatibili, vedere www.occhio.com/dim_en, dimmer a taglio di fase discendente e Occhio air non combinabili

Sento parete singolo up panoramica degli inserti

testa monodirezionale				
lente per faretto				
vetro satinato (opzionale)				
vetro con bordo levigato (opzionale)				
lente di fresnel				
filtro di colore (opzionale, potenza della sorgente di luce max. 18 W)				
vetro diffusore				
lente				
				
	Sento B	Sento C	Sento S30	Sento S40
lente				
vetro diffusore				
filtro di colore (opzionale, potenza della sorgente di luce max. 18 W)				
vetro con bordo levigato (opzionale)				
vetro satinato (opzionale)				
testa biemissione				
vetro satinato (opzionale)				
vetro con bordo levigato (opzionale)				
filtro di colore (opzionale, potenza della sorgente di luce max. 18 W)				
vetro diffusore				
lente				
				
		Sento A	Sento D	Sento E

Sento parete singolo up effetti di illuminazione

 testa lato unico

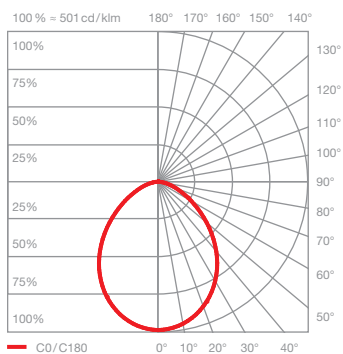
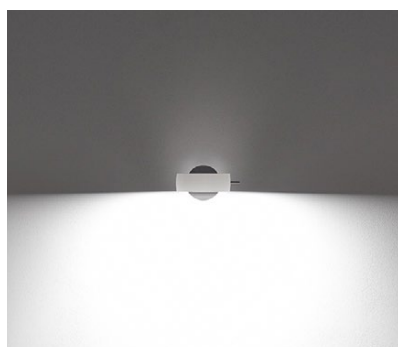

Sento B

luce diffusa

inserto: vetro diffusore

flusso luminoso:	perfect color	26 W	1370lm
	high flux	26 W	1870lm
	perfect color	18 W	1000lm
	high flux	18 W	1370lm

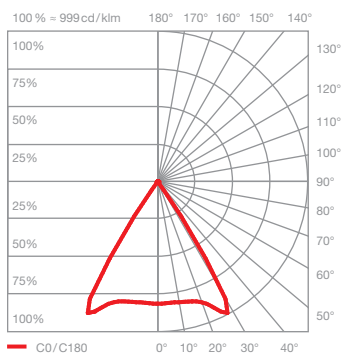

Sento C

luce diretta

inclinazione del fascio ca. 80°

inserto:	lente		
flusso luminoso:	perfect color	26 W	1570lm
	high flux	26 W	2150lm
	perfect color	18 W	1140lm
	high flux	18 W	1570lm

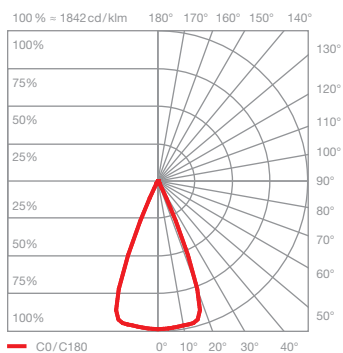
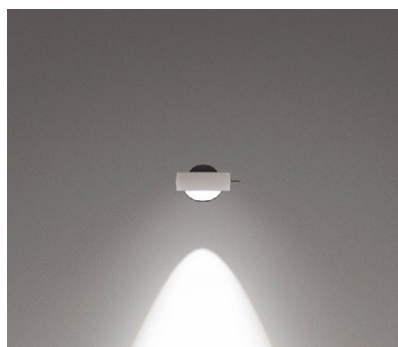

Sento S40

luce diretta

inclinazione del fascio ca. 40°

inserto:	lente per faretto, lente vetro con bordo levigato		
flusso luminoso:	perfect color	26 W	1560lm
	high flux	26 W	2130lm
	perfect color	18 W	1130lm
	high flux	18 W	1560lm

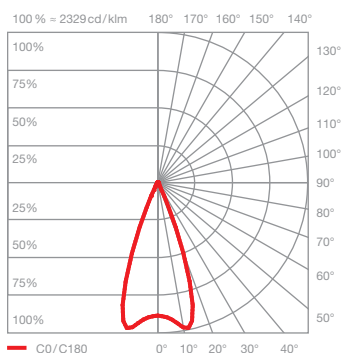

Sento S30

luce diretta

inclinazione del fascio ca. 30°

inserto:	lente per faretto, lente lente di fresnel		
flusso luminoso:	perfect color	26 W	1530lm
	high flux	26 W	2080lm
	perfect color	18 W	1110lm
	high flux	18 W	1530lm

Sento parete singolo up effetti di illuminazione

 testa due lati

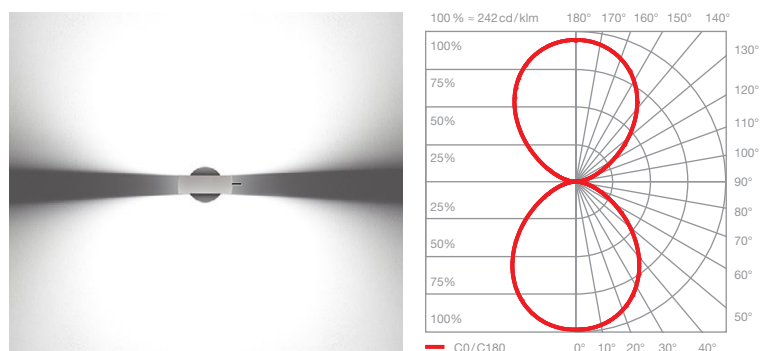

Sento A

luce diffusa in entrambe le direzioni

inserto: vetro diffusore
vetro diffusore

flusso luminoso:	perfect color	26 W	1500 lm
	high flux	26 W	2040 lm
	perfect color	18 W	1090 lm
	high flux	18 W	1500 lm

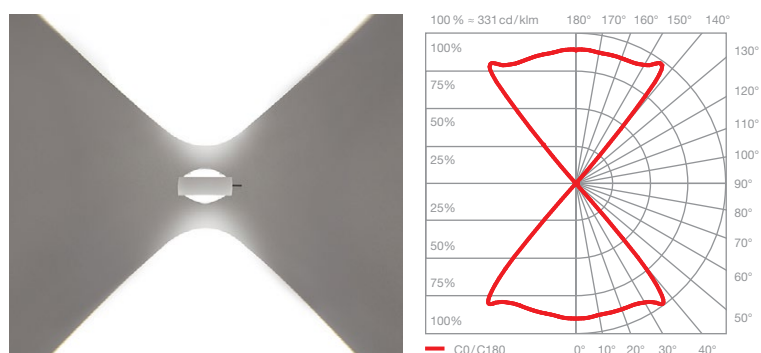

Sento D

luce diretta in entrambe le direzioni
inclinazione del fascio ca. 80°

inserto: lente
lente

flusso luminoso:	perfect color	26 W	1750 lm
	high flux	26 W	2390 lm
	perfect color	18 W	1270 lm
	high flux	18 W	1750 lm



Sento E

luce diffusa verso l'alto
luce diretta verso il basso
inclinazione del fascio ca. 80°

inserto: vetro diffusore
lente

flusso luminoso:	perfect color	26 W	1620 lm
	high flux	26 W	2200 lm
	perfect color	18 W	1170 lm
	high flux	18 W	1620 lm