

## Sento parete doppio up scheda tecnica

Lampada da parete a LED con base alta che include un alimentatore (convertitore) per il montaggio su un soffitto o su una parete, collegamento a 230 V. Il sistema modulare testa / corpo con LED consente di combinare liberamente finiture differenti per testa, corpo e base. Testa rimovibile per la configurazione e la manutenzione, LED sostituibile. Le teste sono disponibili con emissione luminosa su un unico lato o su due lati, potenza della sorgente di luce 18 W o 26 W. L'effetto di illuminazione può essere modificato tramite inserti opzionali; è possibile aggiungere filtri di colore diecrici. Regolazione mediante perno in carbonio disaccoppiato a caldo (il fissaggio della testa contro la rotazione è opzionale). Regolabile con un dimmer a taglio di fase discendente esterno o via »touchless control«, ovvero controllo gestuale sulla testa.

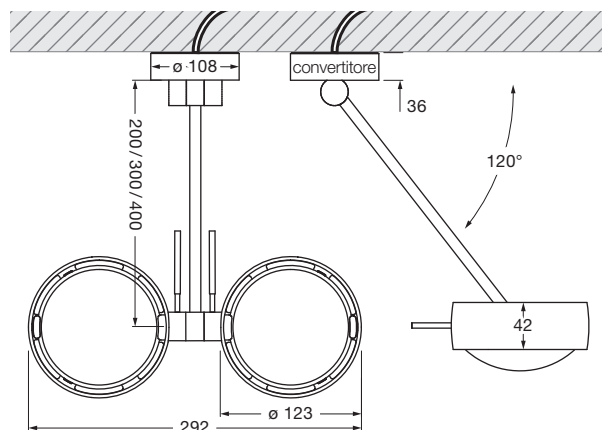













































dimensioni in mm

### dati tecnici Sento parete doppio up

proprietà	materiale	alluminio, acciaio cromato, verniciato o anodizzato, plastica, vetro, plastica ottica
	lunghezza	200 / 300 / 400 mm
	gamma di rotazione, rotazione testa	120°, 360°
	peso	3,0 kg
superficie	testa	oro opaco, oro rosa, bronzo, cromato brillante, cromato opaco, bianco lucido, bianco opaco, nero opaco, phantom, black phantom
	corpo	bianco opaco, nero opaco, cromato brillante, cromato opaco
	base	cromato brillante, bianco lucido, cromato opaco, bianco opaco
Occhio LED	durata media	> 50.000 ore
	classe di efficienza energetica (efficacia luminosa)	G (testa lato unico 62 lm/W, testa due lati 69 lm/W)
	alimentazione	2 x LED 26 W (incl. alimentatore Occhio circa 30 W, modo stand-by < 0,5 W) / 2 x LED 18 W (incl. alimentatore Occhio circa 22 W, modo stand-by < 0,5 W)
	indice di resa cromatica	colore perfetto; CRI Ra 97      flusso alto; CRI Ra 85
	temperatura del colore (coerenza dei colori)	2700, 3000 K (2-step)      3000, 3500, 4000 K (2-step)
elettricità	attenuazione	»touchless control« e Occhio air (opzionale) o con un dimmer a taglio di fase discendente* (a seconda del driver)
	alimentatore	integrato, per l'uso con 230 V CA
	alimentatore con fattore di potenza (cos φ1)	0,9
	sfarfallio / dell'effetto stroboscopico	1 (PstLM) / 0,9 (SVM)
	condizioni operative consentite	max. 30 °C solo per uso interno

\* Per un elenco dei dimmer compatibili, vedere [www.occhio.com/dim\\_en](http://www.occhio.com/dim_en), dimmer a taglio di fase discendente e Occhio air non combinabili

## Sento parete doppio up panoramica degli inserti

testa monodirezionale				
lente per faretto				
vetro satinato (opzionale)				
vetro con bordo levigato (opzionale)				
lente di fresnel				
filtro di colore (opzionale, potenza della sorgente di luce max. 18 W)				
vetro diffusore				
lente				
				
	<b>Sento B</b>	<b>Sento C</b>	<b>Sento S30</b>	<b>Sento S40</b>
lente				
vetro diffusore				
filtro di colore (opzionale, potenza della sorgente di luce max. 18 W)				
vetro con bordo levigato (opzionale)				
vetro satinato (opzionale)				
testa biemissione				
vetro satinato (opzionale)				
vetro con bordo levigato (opzionale)				
filtro di colore (opzionale, potenza della sorgente di luce max. 18 W)				
vetro diffusore				
lente				
				
		<b>Sento A</b>	<b>Sento D</b>	<b>Sento E</b>

## Sento parete doppio up effetti di illuminazione

 testa lato unico

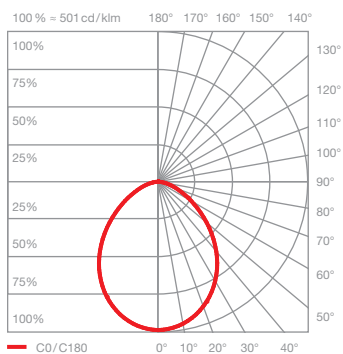
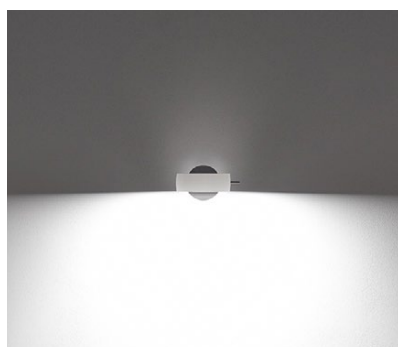

### Sento B

luce diffusa

inserto: vetro diffusore

flusso luminoso: perfect color 2 x 26 W 1370lm  
high flux 2 x 26 W 1870lm

perfect color 2 x 18 W 1000lm  
high flux 2 x 18 W 1370lm

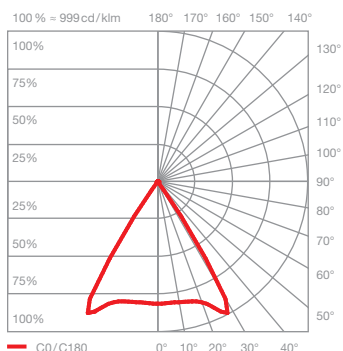

### Sento C

luce diretta

inclinazione del fascio ca. 80°

inserto: lente

flusso luminoso: perfect color 2 x 26 W 1570lm  
high flux 2 x 26 W 2150lm

perfect color 2 x 18 W 1140lm  
high flux 2 x 18 W 1570lm

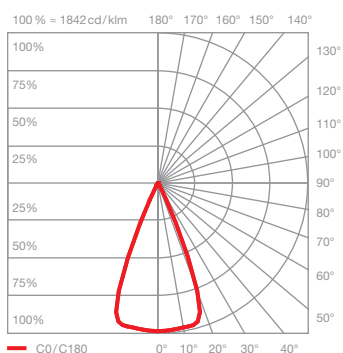

### Sento S40

luce diretta

inclinazione del fascio ca. 40°

inserto: lente per faretto, lente  
vetro con bordo levigato

flusso luminoso: perfect color 2 x 26 W 1560lm  
high flux 2 x 26 W 2130lm

perfect color 2 x 18 W 1130lm  
high flux 2 x 18 W 1560lm

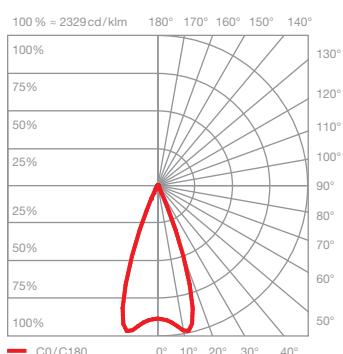
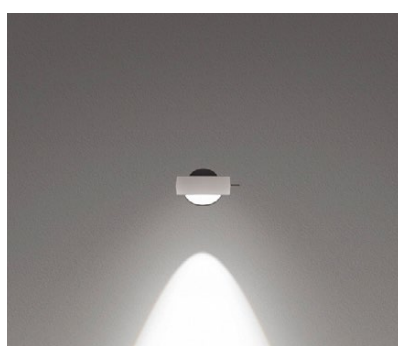

### Sento S30

luce diretta

inclinazione del fascio ca. 30°

inserto: lente per faretto, lente  
lente di fresnel

flusso luminoso: perfect color 2 x 26 W 1530lm  
high flux 2 x 26 W 2080lm

perfect color 2 x 18 W 1110lm  
high flux 2 x 18 W 1530lm

## Sento parete doppio up effetti di illuminazione

 testa due lati

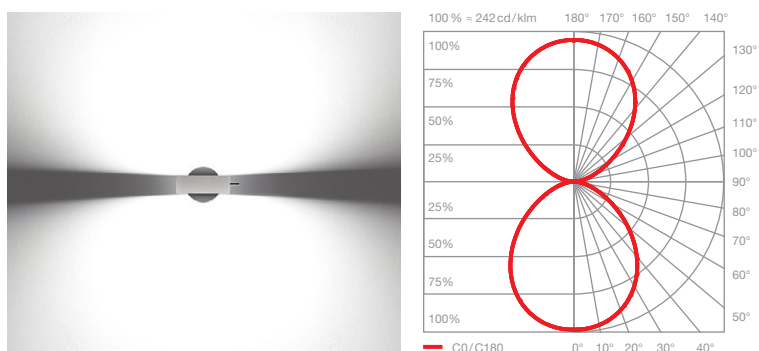

### Sento A

luce diffusa in entrambe le direzioni

inserto: vetro diffusore  
vetro diffusore

flusso luminoso: perfect color 2 x 26 W 1500 lm  
high flux 2 x 26 W 2040 lm  
perfect color 2 x 18 W 1090 lm  
high flux 2 x 18 W 1500 lm

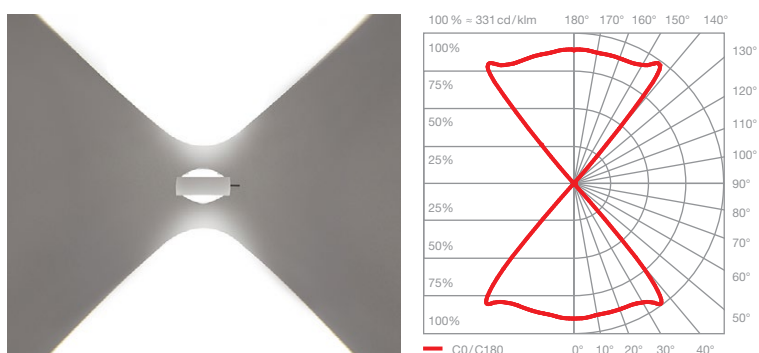

### Sento D

luce diretta in entrambe le direzioni  
inclinazione del fascio ca. 80°

inserto: lente  
lente

flusso luminoso: perfect color 2 x 26 W 1750 lm  
high flux 2 x 26 W 2390 lm  
perfect color 2 x 18 W 1270 lm  
high flux 2 x 18 W 1750 lm



### Sento E

luce diffusa verso l'alto  
luce diretta verso il basso  
inclinazione del fascio ca. 80°

inserto: vetro diffusore  
lente

flusso luminoso: perfect color 2 x 26 W 1620 lm  
high flux 2 x 26 W 2200 lm  
perfect color 2 x 18 W 1170 lm  
high flux 2 x 18 W 1620 lm