

Sento faro up pro scheda tecnica

Lampada da soffitto a LED con base alta che include un driver Occhio per il montaggio su un soffitto pieno, collegamento a 230 V. Il sistema modulare testa / corpo con LED consente di combinare liberamente finiture differenti per testa, corpo e base. Testa rimovibile per la configurazione e la manutenzione, LED sostituibile (2700 K / 3000 K / 4000 K) Le teste sono disponibili con emissione luminosa su un unico lato o su due lati, il corpo è disponibile nelle lunghezze 100/200/300 cm, emissione luminosa 26 W.

L'effetto di illuminazione può essere modificato inserendo degli inserti opzionali, è possibile anche utilizzare dei filtri di colore dicroici. Regolazione mediante perno in carbonio disaccoppiato a caldo. La testa può essere fissata per evitare la torsione.

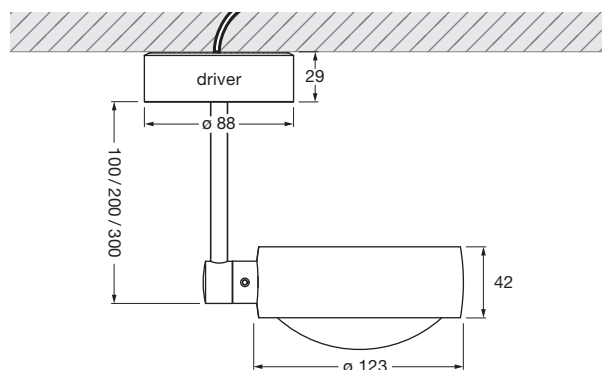













































dimensioni in mm

dati tecnici Sento faro up pro

| | | |
|-------------|--|--|
| proprietà | materiale | alluminio, acciaio cromato, verniciato o anodizzato, plastica, vetro, plastica ottica |
| | lunghezza | 100/200/300 mm |
| | rotazione testa | 360° |
| | mobilità corpo | 360° (con stop) |
| | peso | 1,5 kg |
| superficie | testa | oro opaco, oro rosa, bronzo, cromato brillante, cromato opaco, bianco lucido, bianco opaco, nero opaco, phantom, black phantom |
| | corpo | bianco opaco, nero opaco, cromato brillante, cromato opaco |
| | base | cromato brillante, bianco lucido, cromato opaco, bianco opaco, nero opaco |
| Occhio LED | durata media | > 50.000 ore |
| | classe di efficienza energetica (efficacia luminosa) | G (testa lato unico 66 lm/W, testa due lati 73 lm/W) |
| | potenza per un lato / due lati | LED 26 W max. 700 mA (>36 V CC) / max. 2 x 350 mA (>36 V CC) |
| | indice di resa cromatica | colore perfetto; CRI Ra 97 flusso alto; CRI Ra 85 |
| | temperatura del colore | 2700, 3000, 4000 K 3000, 3500, 4000 K |
| elettricità | attenuazione | tramite dimmer a taglio di fase discendente* |
| | alimentatore | integrato, per l'uso con 230 V CA |
| | condizioni operative consentite | max. 30 °C solo per uso interno |

* Per un elenco dei dimmer compatibili, vedere www.occhio.com/dim_en

Sento faro up pro panoramica degli inserti

| | | | | |
|--|--|---|---|---|
| testa monodirezionale |  |  |  |  |
| lente per faretto | | |  |  |
| vetro satinato (opzionale) | |  | | |
| vetro con bordo levigato (opzionale) | |  | |  |
| lente di fresnel | | |  | |
| filtro di colore (opzionale, potenza della sorgente di luce max. 18 W) |  |  | |  |
| vetro diffusore |  | | | |
| lente | |  |  |  |
| |  |  |  |  |
| | Sento B | Sento C | Sento S30 | Sento S40 |
| lente | | |  | |
| vetro diffusore | |  | |  |
| filtro di colore (opzionale, potenza della sorgente di luce max. 18 W) | |  |  |  |
| vetro con bordo levigato (opzionale) | | |  | |
| vetro satinato (opzionale) | | |  | |
| testa biemissione | |  |  |  |
| vetro satinato (opzionale) | | |  |  |
| vetro con bordo levigato (opzionale) | | |  |  |
| filtro di colore (opzionale, potenza della sorgente di luce max. 18 W) | |  |  |  |
| vetro diffusore | |  | | |
| lente | | |  |  |
| | |  |  |  |
| | | Sento A | Sento D | Sento E |

Sento faro up pro effetti di illuminazione

 testa lato unico

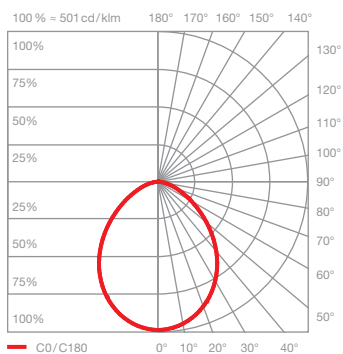
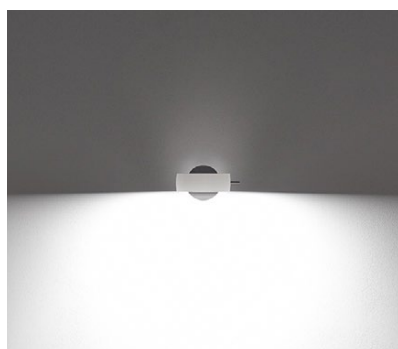

Sento B

luce diffusa

inserto: vetro diffusore

flusso luminoso: perfect color 26 W 1370lm
high flux 26 W 1870lm

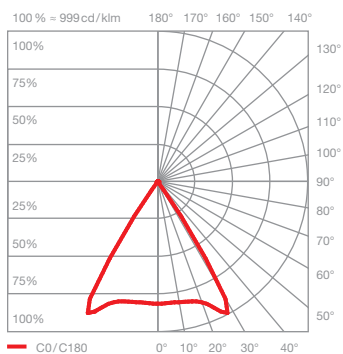

Sento C

luce diretta

inclinazione del fascio ca. 80°

inserto: lente
flusso luminoso: perfect color 26 W 1570lm
high flux 26 W 2150lm

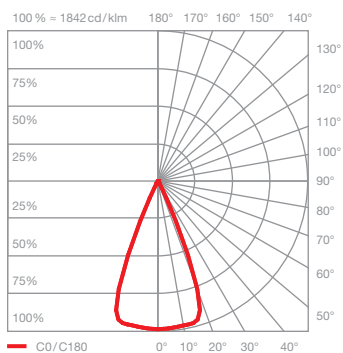

Sento S40

luce diretta

inclinazione del fascio ca. 40°

inserto: lente per faretto, lente
vetro con bordo levigato

flusso luminoso: perfect color 26 W 1560lm
high flux 26 W 2130lm

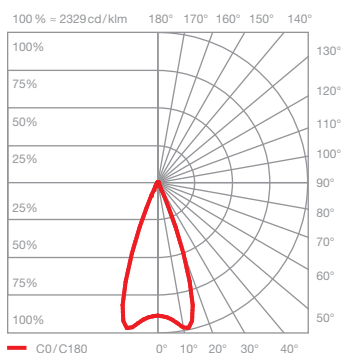

Sento S30

luce diretta

inclinazione del fascio ca. 30°

inserto: lente per faretto, lente
lente di fresnel

flusso luminoso: perfect color 26 W 1530lm
high flux 26 W 2080lm

Sento faro up pro effetti di illuminazione

 testa due lati

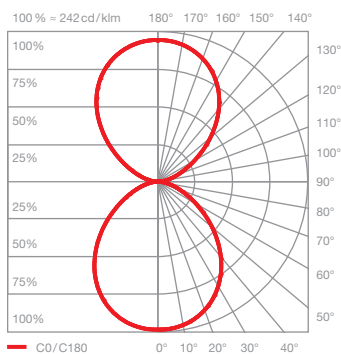
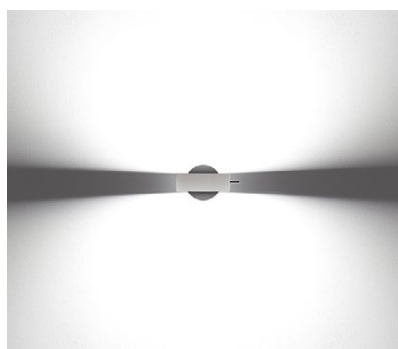

Sento A

luce diffusa in entrambe le direzioni

inserto: vetro diffusore
vetro diffusore

flusso luminoso: perfect color 26 W 1500lm
high flux 26 W 2040lm

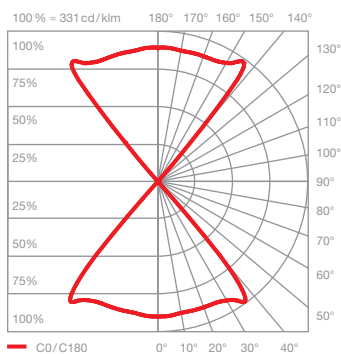

Sento D

luce diretta in entrambe le direzioni
inclinazione del fascio ca. 80°

inserto: lente
lente

flusso luminoso: perfect color 26 W 1750lm
high flux 26 W 2390lm

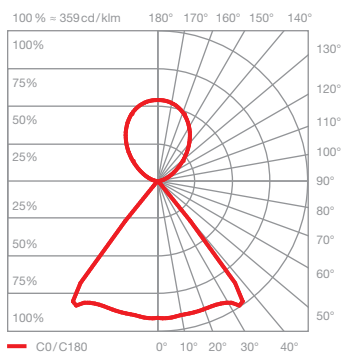
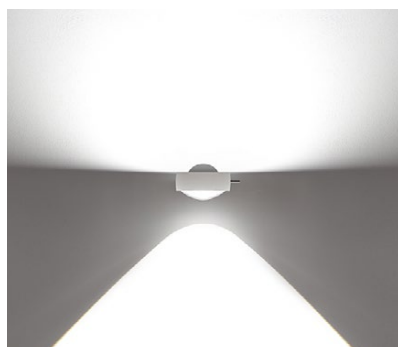

Sento E

luce diffusa verso l'alto
luce diretta verso il basso
inclinazione del fascio ca. 80°

inserto: vetro diffusore
lente

flusso luminoso: perfect color 26 W 1620lm
high flux 26 W 2200lm