

Sento faro track scheda tecnica

Lampada da soffitto a LED con alloggiamento per binario e alimentatore integrato (convertitore) per il binario. Il sistema modulare testa / corpo con LED consente di combinare liberamente finiture differenti per testa, corpo e base. Testa rimovibile per la configurazione e la manutenzione, LED sostituibile. Le teste sono disponibili con emissione luminosa su un unico lato o su due lati, potenza della sorgente di luce 18 W o 26 W. L'effetto di illuminazione può essere modificato tramite inserti opzionali; è possibile aggiungere filtri di colore dicroici. Regolazione mediante perno in carbonio disaccoppiato a caldo (il fissaggio della testa contro la rotazione è opzionale). Regolabile con un dimmer a taglio di fase discendente esterno o via »touchless control«, ovvero controllo gestuale sulla testa.

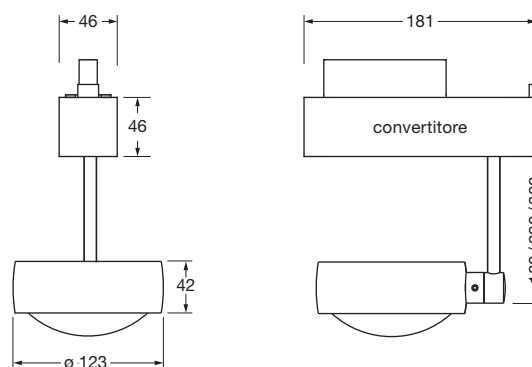

dimensioni in mm













































dati tecnici Sento faro track

proprietà	materiale	alluminio, acciaio cromato, verniciato o anodizzato, plastica, vetro, plastica ottica	
	lunghezza	100 / 200 / 300 mm	
	rotazione testa	360°	
	mobilità corpo	360° (con stop)	
	peso	1,5 kg	
superficie	testa	oro opaco, oro rosa, bronzo, cromato brillante, cromato opaco, bianco lucido, bianco opaco, nero opaco, phantom, black phantom	
	corpo	bianco opaco, nero opaco, cromato brillante, cromato opaco	
	alloggiamento per binario	cromato brillante, bianco lucido, cromato opaco, bianco opaco, nero opaco	
Occhio LED	durata media	> 50.000 ore	
	classe di efficienza energetica (efficacia luminosa)	G (testa lato unico 62 lm/W, testa due lati 69 lm/W)	
	alimentazione	LED 26 W (incl. alimentatore Occhio circa 30 W, modo stand-by < 0,5 W) / LED 18 W (incl. alimentatore Occhio circa 22 W, modo stand-by < 0,5 W)	
	indice di resa cromatica	colore perfetto; CRI Ra 97	flusso alto; CRI Ra 85
	temperatura del colore (coerenza dei colori)	2700, 3000 K (2-step)	3000, 3500, 4000 K (2-step)
	elettricità	attenuazione	»touchless control« e Occhio air (opzionale) o con un dimmer a taglio di fase discendente* (a seconda del driver)
alimentatore		tensione operativa integrata 230 V CA	
alimentatore con fattore di potenza (cos φ1)		0,9	
sfarfallio / dell'effetto stroboscopico		1 (PstLM) / 0,9 (SVM)	
condizioni operative consentite		max. 30 °C solo per uso interno	

* dimmer a taglio di fase discendente e Occhio air non combinabili



Sento faro track panoramica degli inserti

testa monodirezionale				
lente per faretto				
vetro satinato (opzionale)				
vetro con bordo levigato (opzionale)				
lente di fresnel				
filtro di colore (opzionale, potenza della sorgente di luce max. 18 W)				
vetro diffusore				
lente				
				
	Sento B	Sento C	Sento S30	Sento S40
lente				
vetro diffusore				
filtro di colore (opzionale, potenza della sorgente di luce max. 18 W)				
vetro con bordo levigato (opzionale)				
vetro satinato (opzionale)				
testa biemissione				
vetro satinato (opzionale)				
vetro con bordo levigato (opzionale)				
filtro di colore (opzionale, potenza della sorgente di luce max. 18 W)				
vetro diffusore				
lente				
				
		Sento A	Sento D	Sento E

Sento faro track effetti di illuminazione

 testa lato unico

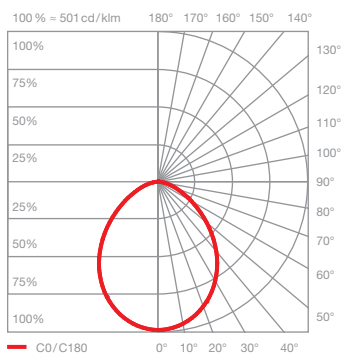

Sento B

luce diffusa

inserto: vetro diffusore

flusso luminoso:	perfect color	26 W	1370lm
	high flux	26 W	1870lm
	perfect color	18 W	1000lm
	high flux	18 W	1370lm

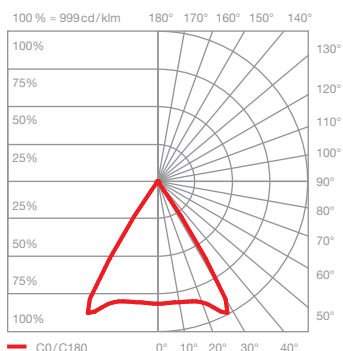

Sento C

luce diretta

inclinazione del fascio ca. 80°

inserto:	lente		
flusso luminoso:	perfect color	26 W	1570lm
	high flux	26 W	2150lm
	perfect color	18 W	1140lm
	high flux	18 W	1570lm

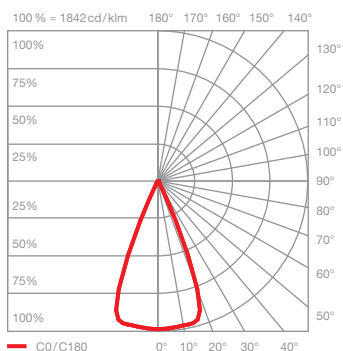

Sento S40

luce diretta

inclinazione del fascio ca. 40°

inserto: lente per faretto, lente
vetro con bordo levigato

flusso luminoso:	perfect color	26 W	1560lm
	high flux	26 W	2130lm
	perfect color	18 W	1130lm
	high flux	18 W	1560lm

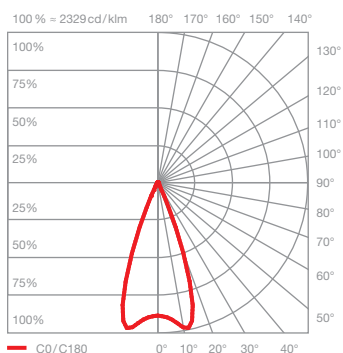
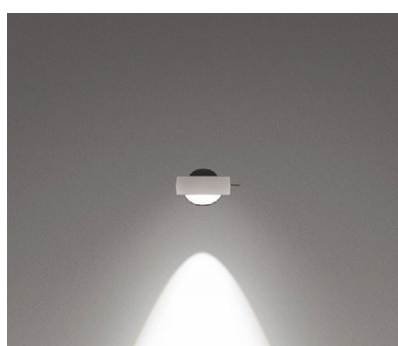

Sento S30

luce diretta

inclinazione del fascio ca. 30°

inserto: lente per faretto, lente
lente di fresnel

flusso luminoso:	perfect color	26 W	1530lm
	high flux	26 W	2080lm
	perfect color	18 W	1110lm
	high flux	18 W	1530lm

Sento faro track effetti di illuminazione

 testa due lati

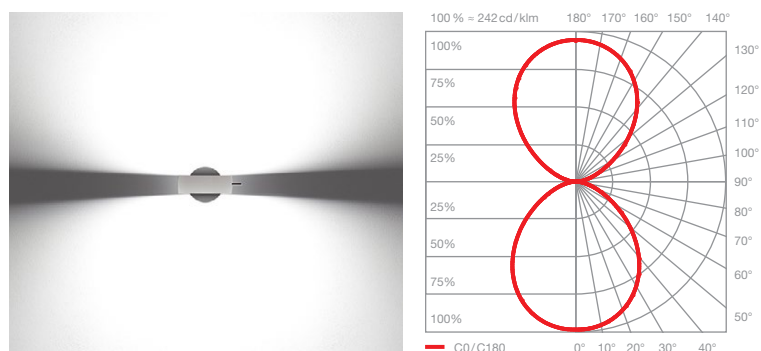

Sento A

luce diffusa in entrambe le direzioni

inserto: vetro diffusore
vetro diffusore

flusso luminoso:	perfect color	26 W	1500 lm
	high flux	26 W	2040 lm
	perfect color	18 W	1090 lm
	high flux	18 W	1500 lm

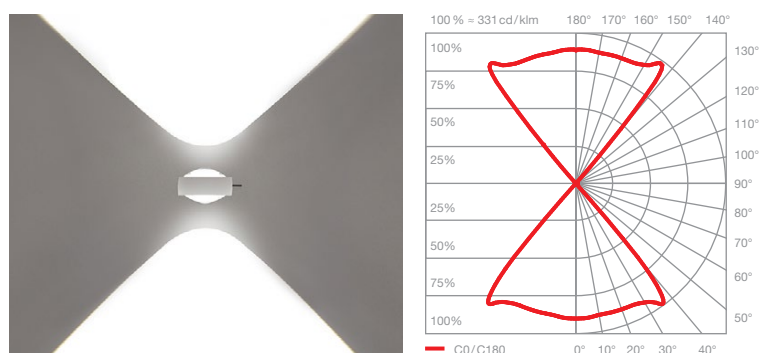

Sento D

luce diretta in entrambe le direzioni
inclinazione del fascio ca. 80°

inserto: lente
lente

flusso luminoso:	perfect color	26 W	1750 lm
	high flux	26 W	2390 lm
	perfect color	18 W	1270 lm
	high flux	18 W	1750 lm

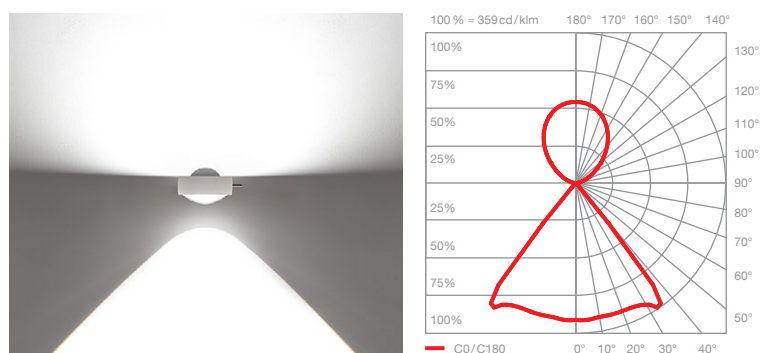

Sento E

luce diffusa verso l'alto
luce diretta verso il basso
inclinazione del fascio ca. 80°

inserto: vetro diffusore
lente

flusso luminoso:	perfect color	26 W	1620 lm
	high flux	26 W	2200 lm
	perfect color	18 W	1170 lm
	high flux	18 W	1620 lm