

Sento sospeso pure datasheet

LED suspended luminaire with double sided light output, luminous power 32 W. Ratio of up and down light adjustable. Lighting effect changeable via optional inserts.

trimless-version with height adjustment: LED suspended luminaire freely height adjustable incl. plaster plate for flush mounting on hollow ceiling, connection to remote constant voltage source (converter). Remote dimmable (depending on power supply unit) or with gestures »touchless fading« on the head.

trimless-version with fixed length: LED suspended luminaire with fixed adjustable height incl. plaster plate for flush mounting on hollow ceiling, connection to remote constant voltage source (converter). Remote dimmable (depending on power supply unit) or with gestures »touchless fading« on the head.

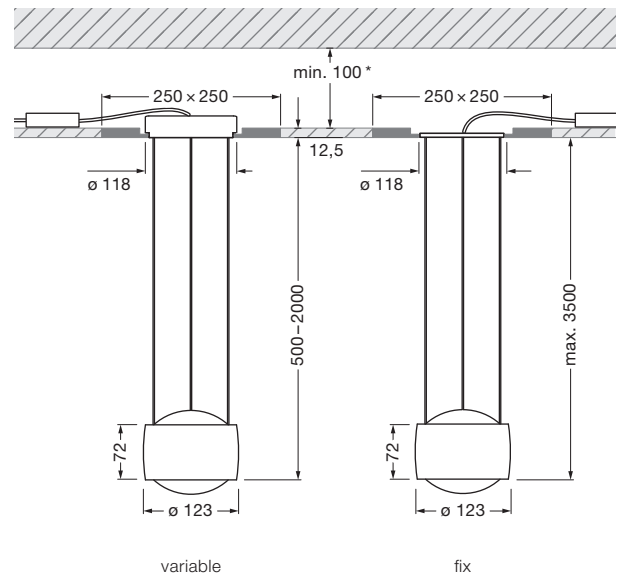

* with Occhio converter

dimensions in mm















technical data Sento sospeso pure

properties	material	aluminium, steel chrome-plated, painted or anodised, plastic, glass, optical plastic
	height adjustment (variable)	500 – 2000 mm (variable)
	height setting (fix)	max. 3500 mm (can be adjusted during fitting)
	weight	variable: 2.4 kg / fix: 1.9 kg
surface	head	shiny chrome, matt chrome, glossy white, matt white, matt black, matt gold, rose gold, bronze, phantom, black phantom
	base	matt white
Occhio LED	average life time	> 50.000 hrs
	energy efficiency class (luminous efficiency)	G (72 lm / W)
	power	LED 32 W (incl. Occhio power supply unit approx. 38 W, standby < 0.5 W) / LED 26 W* (incl. Occhio power supply unit approx. 34 W, standby < 0.5 W)
	color rendering index	perfect color; CRI Ra 97 high flux; CRI Ra 85
	color temperature (color consistency)	2700, 3000 K (2-step) 3000, 3500, 4000 K (2-step)
electricity	dimming	»touchless control« and Occhio air (optional) or via trailing-edge phasecut dimmer** (depends on driver)
	power supply unit	remote, driven by constant voltage source 48 V DC / min. 40 W
	power factor power supply (cos φ1)	0.9
	flicker / stroboscopic effect	1 (PstLM) / 0.9 (SVM)
	permitted operating conditions	max. 30°C for indoor use only

* version chrome, rose gold, bronze, phantom ** trailing-edge phasecut dimmer and Occhio air not combinable



Sento sospeso pure overview inserts

lens		
diffuser glass		
soft edge glass (optional)		
satinised glass (optional)		
double-sided head		
satinised glass (optional)		
soft edge glass (optional)		
lens		
		
	Sento D	Sento E

Sento sospeso pure lighting effects

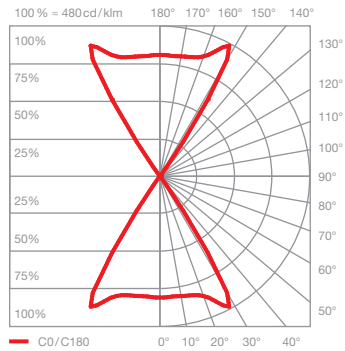

Sento D

directed light in both directions beam angle approx. 80°

inserts: lens
lens

luminous flux:	perfect color	32 W	2070 lm
	high flux	32 W	2920 lm
	perfect color	26 W	1690 lm
	high flux	26 W	2300 lm

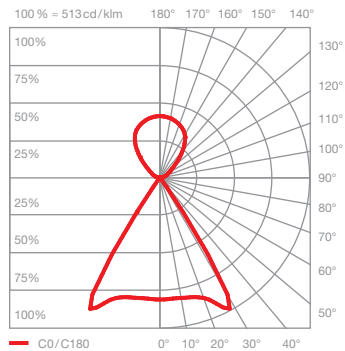

Sento E

diffuse up light directed down light beam angle approx. 80°

inserts: satinised glass
lens

luminous flux:	perfect color	32 W	1940 lm
	high flux	32 W	2730 lm
	perfect color	26 W	1580 lm
	high flux	26 W	2150 lm