

## Sento soffitto singolo flat datasheet

LED ceiling mounted luminaire with a flat base for mounting on cavity box. Connection to a remote constant voltage source (converter). Modular LED head-body-system allows free combination of different surfaces of head, body and base. Removable head for configuration and maintenance purposes, LED changeable. Heads available with one sided or double sided light output, power of light source 18 W or 26 W.

Lighting effect changeable by using optional inserts, dichroic color filters can be added. Adjustment via heat-decoupled carbon pin (fixation of head against rotation optional). Controllable via external dimmer (depending on the power supply unit) or via »touchless control« with gestures at the head.

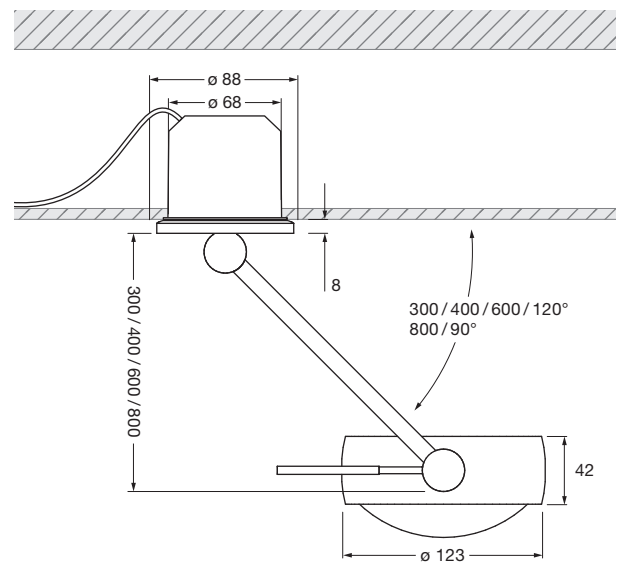













































dimensions in mm

### technical data Sento soffitto singolo flat

properties	material	aluminium, steel chrome-plated, painted or anodised, plastic, glass, optical plastic
	length	300 / 400 / 600 / 800 mm
	swivel range, rotation head	300, 400, 600 mm 120° / 800 mm 90°, 360°
	weight	1.6 kg
surface	head	matt gold, rose gold, bronze, shiny chrome, matt chrome, glossy white, matt white, matt black, phantom, black phantom
	body	matt white, matt black, shiny chrome, matt chrome
	base	shiny chrome, glossy white, matt chrome, matt white
Occhio LED	average life time	> 50.000 hrs
	energy efficiency class (luminous efficiency)	G (head single sided 62 lm / W, head double sided 69 lm / W)
	power	LED 26 W (incl. Occhio power supply unit approx. 30 W, standby < 0.5 W) / LED 18 W (incl. Occhio power supply unit approx. 22 W, standby < 0.5 W)
	color rendering index	perfect color; CRI Ra 97      high flux; CRI Ra 85
	color temperature (color consistency)	2700, 3000 K (2-step)      3000, 3500, 4000 K (2-step)
electricity	dimming	»touchless control« and Occhio air (optional) or via trailing-edge phasecut dimmer* (depends on driver)
	power supply unit	remote, driven by constant voltage source 48 V DC / min. 30 W
	power factor power supply (cos φ1)	0.9
	flicker / stroboscopic effect	1 (PstLM) / 0.9 (SVM)
	permitted operating conditions	max. 30°C for indoor use only

\*trailing-edge phasecut dimmer and Occhio air not combinable

## Sento soffitto singolo flat overview inserts

single-sided head				
spot lens				
satinised glass (optional)				
soft edge glass (optional)				
fresnel lens				
color filter (optional, power of light source max. 18 W)				
diffuser glass				
lens				
				
	<b>Sento B</b>	<b>Sento C</b>	<b>Sento S30</b>	<b>Sento S40</b>
lens				
diffuser glass				
color filter (optional, power of light source max. 18 W)				
soft edge glass (optional)				
satinised glass (optional)				
double-sided head				
satinised glass (optional)				
soft edge glass (optional)				
color filter (optional, power of light source max. 18 W)				
diffuser glass				
lens				
				
		<b>Sento A</b>	<b>Sento D</b>	<b>Sento E</b>

## Sento soffitto singolo flat lighting effects

 head single sided

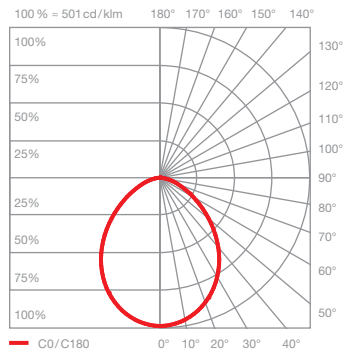
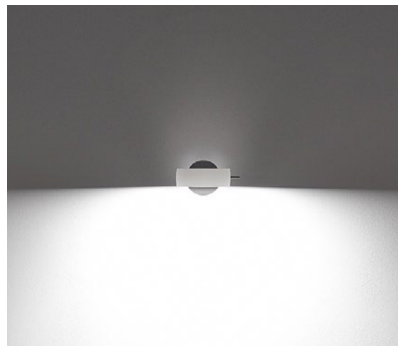

### Sento B

diffuse light

insert: diffusor glass

luminous flux:	perfect color	26 W	1370lm
	high flux	26 W	1870lm
	perfect color	18 W	1000lm
	high flux	18 W	1370lm

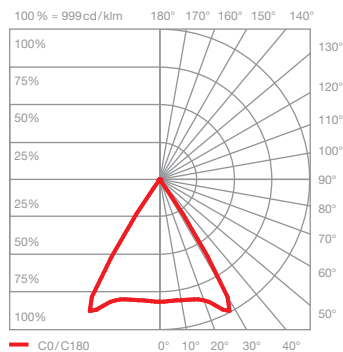

### Sento C

directed light  
beam angle approx. 80°

insert:	lens		
luminous flux:	perfect color	26 W	1570lm
	high flux	26 W	2150lm
	perfect color	18 W	1140lm
	high flux	18 W	1570lm

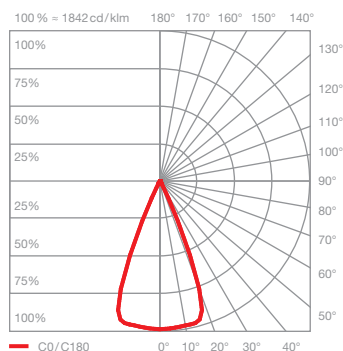
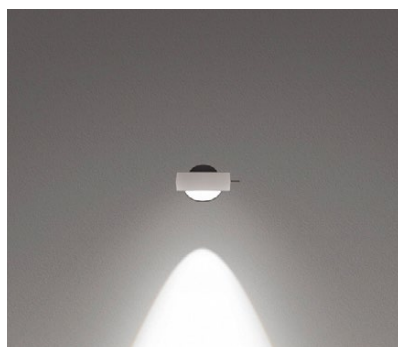

### Sento S40

directed light  
beam angle approx. 40°

insert:	spot lens, lens soft edge glass		
luminous flux:	perfect color	26 W	1560lm
	high flux	26 W	2130lm
	perfect color	18 W	1130lm
	high flux	18 W	1560lm

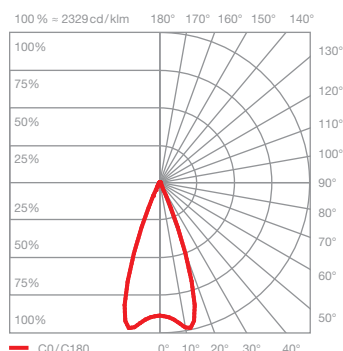

### Sento S30

directed light  
beam angle approx. 30°

insert:	spot lens, lens fresnel lens		
luminous flux:	perfect color	26 W	1530lm
	high flux	26 W	2080lm
	perfect color	18 W	1110lm
	high flux	18 W	1530lm

## Sento soffitto singolo flat lighting effects

 head double sided

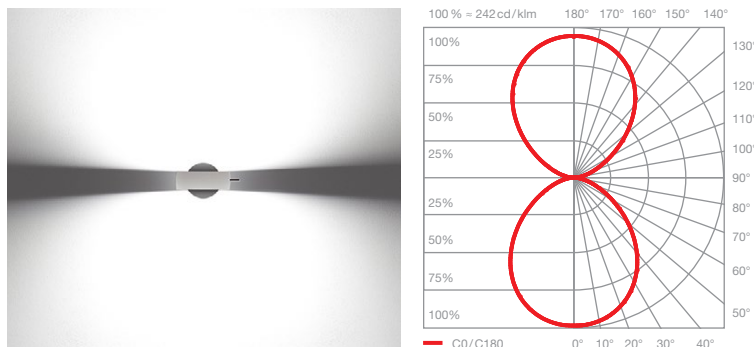

### Sento A

diffuse light in both directions

insert: diffusor glass  
diffusor glass

luminous flux:	perfect color	26 W	1500lm
	high flux	26 W	2040lm
	perfect color	18 W	1090lm
	high flux	18 W	1500lm

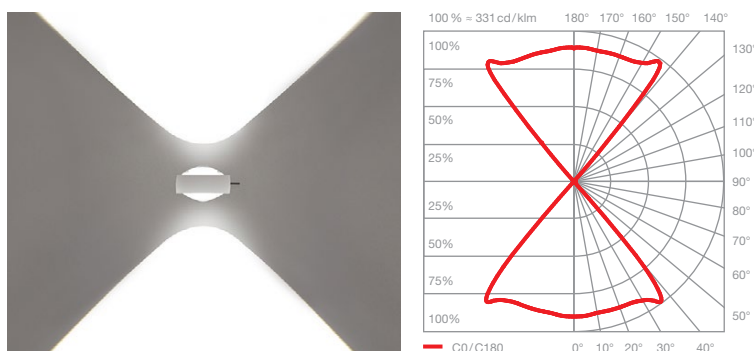

### Sento D

directed light in both directions  
beam angle approx. 80°

insert: lens  
lens

luminous flux:	perfect color	26 W	1750lm
	high flux	26 W	2390lm
	perfect color	18 W	1270lm
	high flux	18 W	1750lm

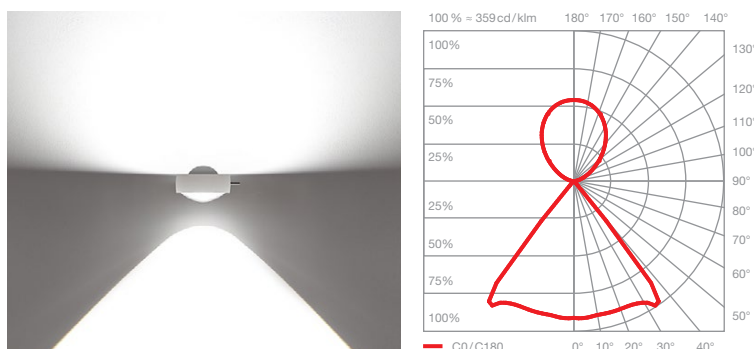

### Sento E

diffuse up light  
directed down light  
beam angle approx. 80°

insert: diffusor glass  
lens

luminous flux:	perfect color	26 W	1620lm
	high flux	26 W	2200lm
	perfect color	18 W	1170lm
	high flux	18 W	1620lm