

Sento soffitto doppio up datasheet

LED ceiling mounted luminaire with a high base, in which the power supply unit (converter) is included for mounting on fixed ceiling or wall, connection to 230V. Modular LED head-body-system allows free combination of different surfaces of head, body and base. Removable head for configuration and maintenance purposes, LED changeable. Heads available with one sided or double sided light output, power of light source 18W or 26W.

Lighting effect changeable by using optional inserts, dichroic color filters can be added. Adjustment via heat-decoupled carbon pin (fixation of head against rotation optional). Dimmable via external trailing edge phase-cut dimmer or via »touchless control« with gestures at the head.

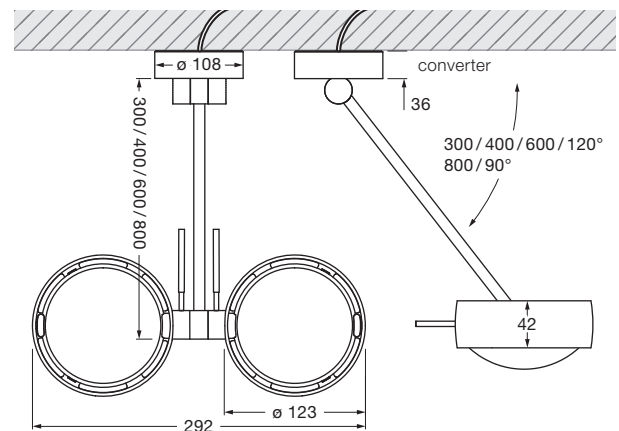













































dimensions in mm

technical data Sento soffitto doppio up

properties	material	aluminium, steel chrome-plated, painted or anodised, plastic, glass, optical plastic
	length	300 / 400 / 600 / 800 mm
	swivel range, rotation head	300–600 mm 120° / 800 mm 90°, 360°
	weight	3.2 kg
surface	head	matt gold, rose gold, bronze, shiny chrome, matt chrome, glossy white, matt white, matt black, phantom, black phantom
	body	matt white, matt black, shiny chrome, matt chrome
	base	shiny chrome, glossy white, matt chrome, matt white
Occhio LED	average life time	> 50.000 hrs
	energy efficiency class (luminous efficiency)	G (head single sided 62 lm / W, head double sided 69 lm / W)
	power	2 x LED 26 W (incl. Occhio power supply unit approx. 30 W, standby < 0.5 W) / 2 x LED 18 W (incl. Occhio power supply unit approx. 22 W, standby < 0.5 W)
	color rendering index	perfect color; CRI Ra 97 high flux; CRI Ra 85
	color temperature (color consistency)	2700, 3000 K (2-step) 3000, 3500, 4000 K (2-step)
electricity	dimming	»touchless control« and Occhio air (optional) or via trailing-edge phasecut dimmer* (depends on driver)
	power supply unit	integrated, for use with 230 V AC
	power factor power supply (cos φ1)	0.9
	flicker / stroboscopic effect	1 (PstLM) / 0.9 (SVM)
	permitted operating conditions	max. 30°C for indoor use only

* For a list of compatible dimmers, see www.occhio.com/dim_en, trailing-edge phasecut dimmer and Occhio air not combinable

Sento soffitto doppio up overview inserts

single-sided head				
spot lens				
satinised glass (optional)				
soft edge glass (optional)				
fresnel lens				
color filter (optional, power of light source max. 18 W)				
diffuser glass				
lens				
				
	Sento B	Sento C	Sento S30	Sento S40
lens				
diffuser glass				
color filter (optional, power of light source max. 18 W)				
soft edge glass (optional)				
satinised glass (optional)				
double-sided head				
satinised glass (optional)				
soft edge glass (optional)				
color filter (optional, power of light source max. 18 W)				
diffuser glass				
lens				
				
		Sento A	Sento D	Sento E

Sento soffitto doppio up lighting effects

 head single sided

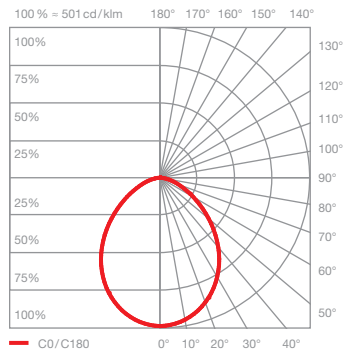
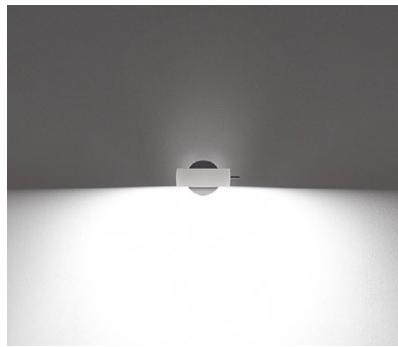

Sento B

diffuse light

insert: diffusor glass

luminous flux: perfect color 2 x 26 W 1370lm
high flux 2 x 26 W 1870lm

perfect color 2 x 18 W 1000lm
high flux 2 x 18 W 1370lm

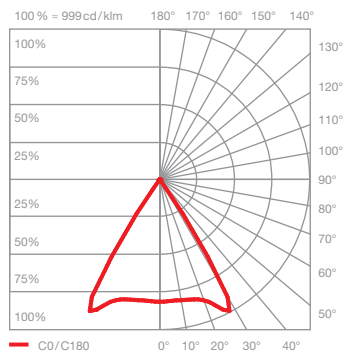

Sento C

directed light
beam angle approx. 80°

insert: lens

luminous flux: perfect color 2 x 26 W 1570lm
high flux 2 x 26 W 2150lm

perfect color 2 x 18 W 1140lm
high flux 2 x 18 W 1570lm

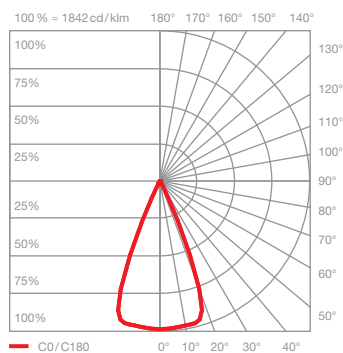
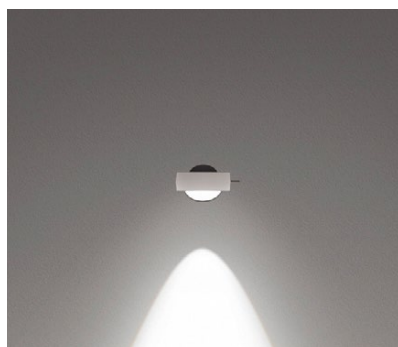

Sento S40

directed light
beam angle approx. 40°

insert: spot lens, lens
soft edge glass

luminous flux: perfect color 2 x 26 W 1560lm
high flux 2 x 26 W 2130lm

perfect color 2 x 18 W 1130lm
high flux 2 x 18 W 1560lm

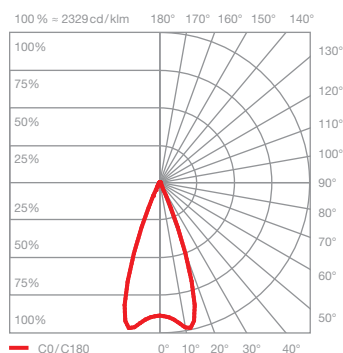

Sento S30

directed light
beam angle approx. 30°

insert: spot lens, lens
fresnel lens

luminous flux: perfect color 2 x 26 W 1530lm
high flux 2 x 26 W 2080lm

perfect color 2 x 18 W 1110lm
high flux 2 x 18 W 1530lm

Sento soffitto doppio up lighting effects

 head double sided

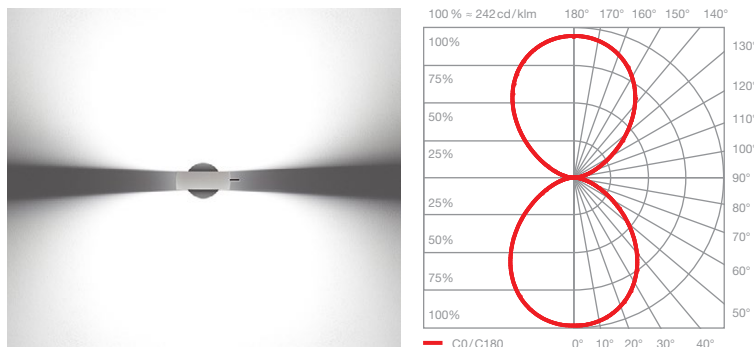

Sento A

diffuse light in both directions

insert: diffusor glass
diffusor glass

luminous flux: perfect color 2 × 26 W 1500 lm
high flux 2 × 26 W 2040 lm

perfect color 2 × 18 W 1090 lm
high flux 2 × 18 W 1500 lm

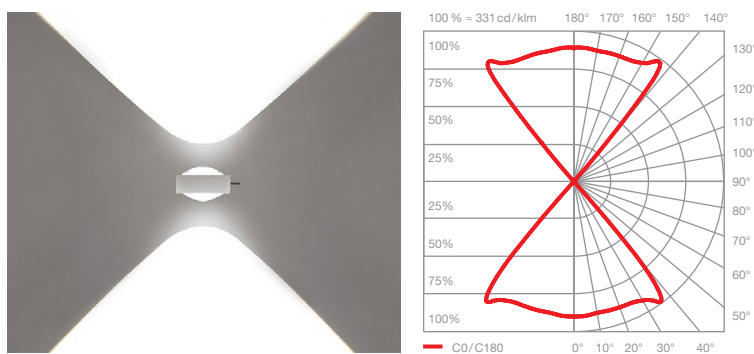

Sento D

directed light in both directions
beam angle approx. 80°

insert: lens
lens

luminous flux: perfect color 2 × 26 W 1750 lm
high flux 2 × 26 W 2390 lm

perfect color 2 × 18 W 1270 lm
high flux 2 × 18 W 1750 lm

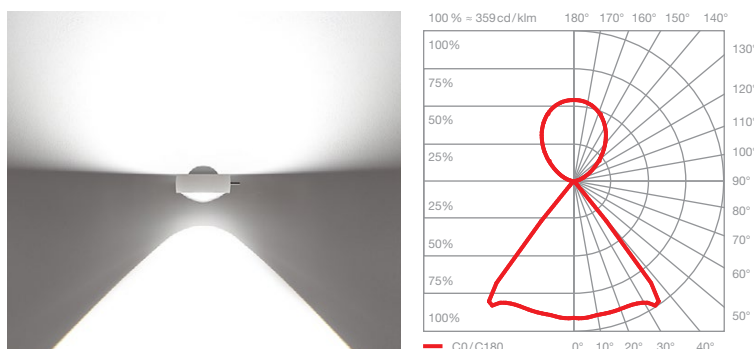

Sento E

diffuse up light
directed down light
beam angle approx. 80°

insert: diffusor glass
lens

luminous flux: perfect color 2 × 26 W 1620 lm
high flux 2 × 26 W 2200 lm

perfect color 2 × 18 W 1170 lm
high flux 2 × 18 W 1620 lm