

## Sento letto up pro datasheet

LED wall luminaire with high base incl. Occhio driver for mounting on solid wall, connection to 230 V. Modular LED head-body system enables free combination of different surfaces of the head, body and base. Removable head for configuration and maintenance purposes, changeable LED (2700 K/3000 K/4000 K). Heads available with single or double-sided light emission, body available in lengths 20/30/40 cm, light output 26 W.

Lighting effect can be changed with optional inserts, dichroic color filters can also be used. Adjustment via heat-decoupled carbon pin. Head can optionally be fixed to prevent twisting.

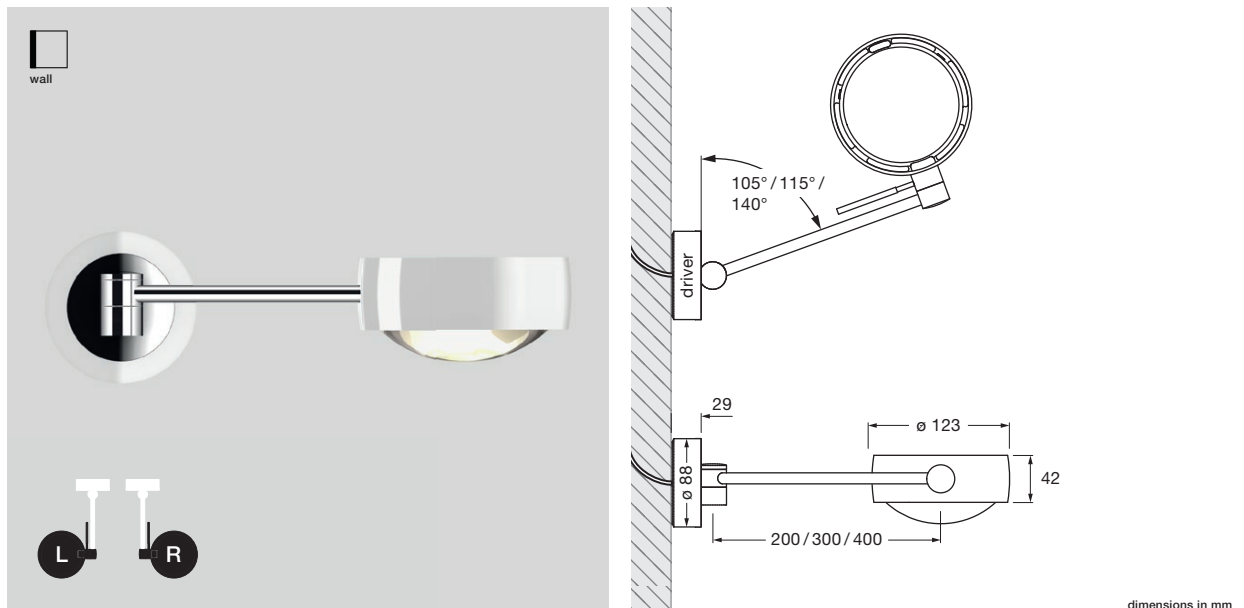













































dimensions in mm

### technical data Sento letto up pro

properties	material	aluminium, steel chrome-plated, painted or anodised, plastic, glass, optical plastic
	length	200 / 300 / 400 mm
	rotation head	360°
	swivel range	200 mm; 105° / 300 mm; 115° / 400 mm; 140°
	weight	1.7 kg
surface	head	matt gold, rose gold, bronze, shiny chrome, matt chrome, glossy white, matt white, matt black, phantom, black phantom
	body	matt white, matt black, shiny chrome, matt chrome
	base	shiny chrome, glossy white, matt chrome, matt white
Occhio LED	average life time	> 50.000 hrs
	energy efficiency class (luminous efficiency)	G (head single sided 66 lm/W, head double sided 73 lm/W)
	power single sided / double sided	LED 26 W max. 700 mA (>36 VDC) / max. 2 x 350 mA (>36 VDC)
	color rendering index	perfect color; CRI Ra 97      high flux; CRI Ra 85
	color temperature	2700, 3000 K, 4000 K      3000, 3500, 4000 K
electricity	dimming	by trailing-edge phase-cut dimmer*
	power supply unit	integrated, for use with 230 V AC
	permitted operating conditions	max. 30°C for indoor use only

\* For a list of compatible dimmers, see [www.occhio.com/dim\\_en](http://www.occhio.com/dim_en)

## Sento letto up pro overview inserts

single-sided head				
spot lens				
satinised glass (optional)				
soft edge glass (optional)				
fresnel lens				
color filter (optional, power of light source max. 18 W)				
diffuser glass				
lens				
				
	<b>Sento B</b>	<b>Sento C</b>	<b>Sento S30</b>	<b>Sento S40</b>
lens				
diffuser glass				
color filter (optional, power of light source max. 18 W)				
soft edge glass (optional)				
satinised glass (optional)				
double-sided head				
satinised glass (optional)				
soft edge glass (optional)				
color filter (optional, power of light source max. 18 W)				
diffuser glass				
lens				
				
		<b>Sento A</b>	<b>Sento D</b>	<b>Sento E</b>

## Sento letto up pro lighting effects

 head single sided

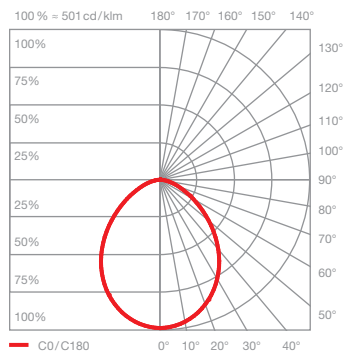
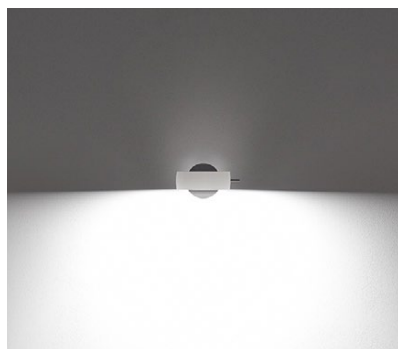

### Sento B

diffuse light

insert: diffusor glass

luminous flux: perfect color 26 W 1370lm  
high flux 26 W 1870lm

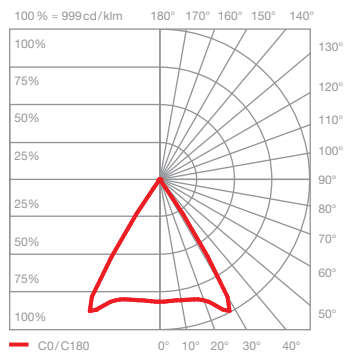

### Sento C

directed light  
beam angle approx. 80°

insert: lens  
luminous flux: perfect color 26 W 1570lm  
high flux 26 W 2150lm

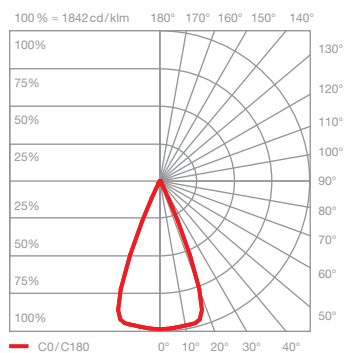
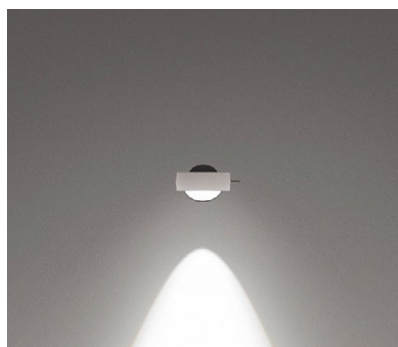

### Sento S40

directed light  
beam angle approx. 40°

insert: spot lens, lens  
soft edge glass

luminous flux: perfect color 26 W 1560lm  
high flux 26 W 2130lm

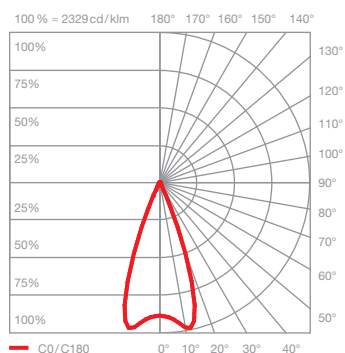

### Sento S30

directed light  
beam angle approx. 30°

insert: spot lens, lens  
fresnel lens

luminous flux: perfect color 26 W 1530lm  
high flux 26 W 2080lm

## Sento letto up pro lighting effects

 head double sided

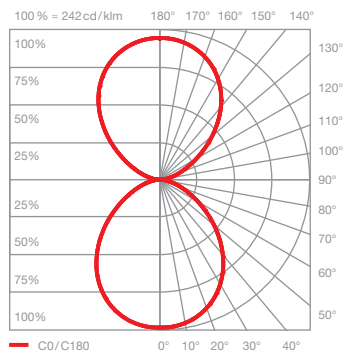
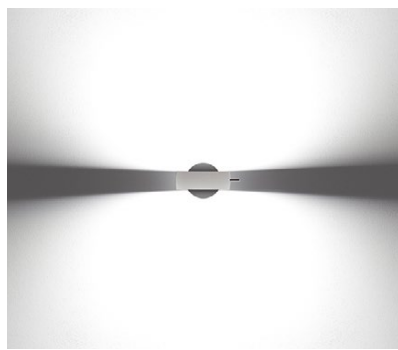

### Sento A

diffuse light in both directions

insert: diffusor glass  
diffusor glass

luminous flux: perfect color 26 W 1500lm  
high flux 26 W 2040lm

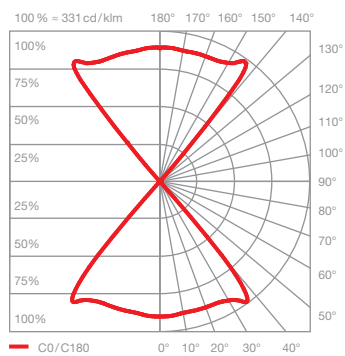

### Sento D

directed light in both directions  
beam angle approx. 80°

insert: lens  
lens

luminous flux: perfect color 26 W 1750lm  
high flux 26 W 2390lm

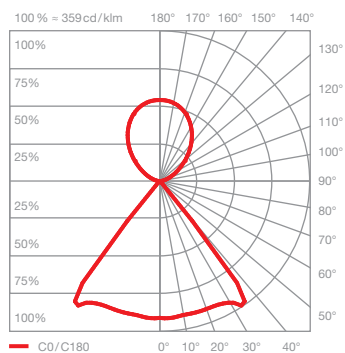
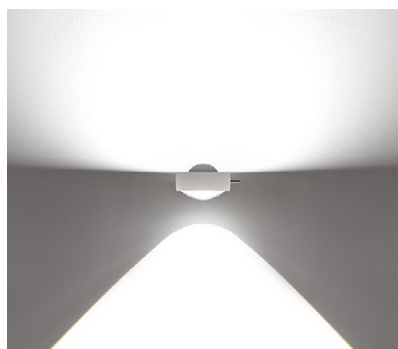

### Sento E

diffuse up light  
directed down light  
beam angle approx. 80°

insert: diffusor glass  
lens

luminous flux: perfect color 26 W 1620lm  
high flux 26 W 2200lm