

Sento filo up pro datasheet

LED suspended luminaire with high base incl. Occhio driver for mounting on solid ceiling, connection to 230 V. Version available with continuous height adjustment or with fixed height adjustment when mounted.

Modular LED head-body system enables free combination of different surfaces of the head, body and base. Removable head for configuration and maintenance purposes, changeable LED (2700 K / 3000 K / 4000 K). Heads available with single or double-sided light emission, light output 26 W.

Lighting effect can be changed with optional inserts, dichroic color filters can also be used. Adjustment via heat-decoupled carbon pin. Head can optionally be fixed to prevent twisting.

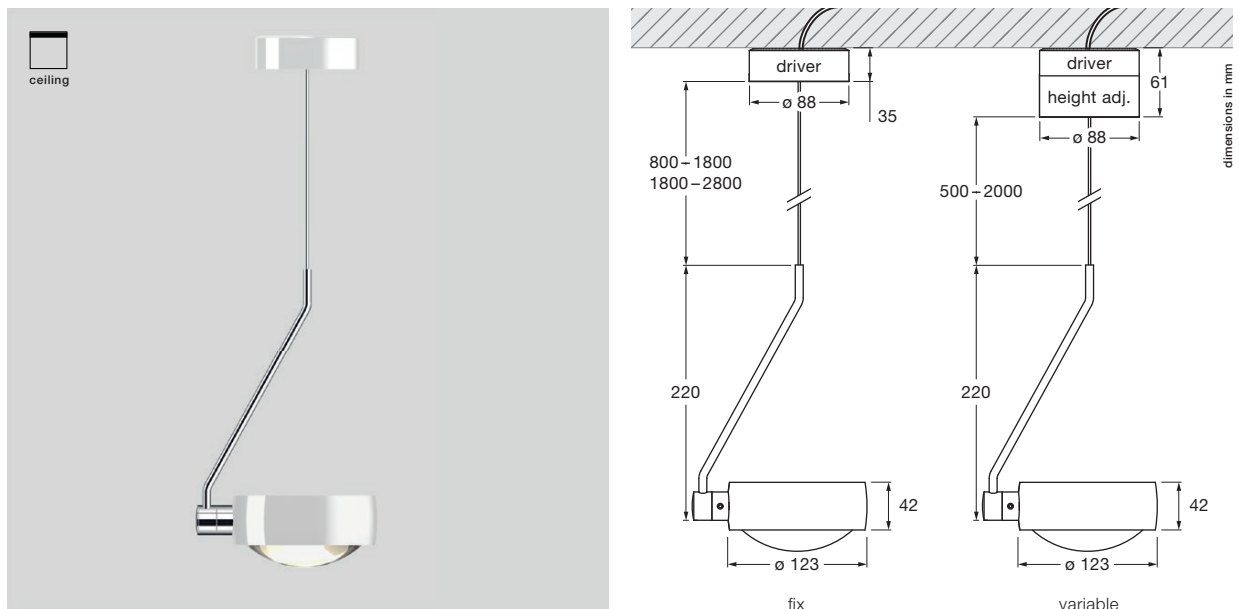













































technical data Sento filo up pro

properties	material	aluminium, steel chrome-plated, painted or anodised, plastic, glass, optical plastic
	length	variable: 500 – 2000 mm / fix: max. 800 – 1800 mm / 1800 – 2800 mm
	rotation head	360°
	movability body	360°
	weight	variable: 2.1 kg / fix: 1.6 kg
surface	head	matt gold, rose gold, bronze, shiny chrome, matt chrome, glossy white, matt white, matt black, phantom, black phantom
	body	matt white, matt black, shiny chrome, matt chrome
	base	shiny chrome, glossy white, matt chrome, matt white, matt black
Occhio LED	average life time	> 50.000 hrs
	energy efficiency class (luminous efficiency)	G (head single sided 66 lm/W, head double sided 73 lm/W)
	power single sided / double sided	LED 26 W max. 700 mA (>36 VDC) / max. 2 x 350 mA (>36 VDC)
	color rendering index	perfect color; CRI Ra 97 high flux; CRI Ra 85
	color temperature	2700, 3000 K, 4000 K 3000, 3500, 4000 K
electricity	dimming	by trailing-edge phase-cut dimmer*
	power supply unit	integrated, for use with 230 V AC
	permitted operating conditions	max. 30°C for indoor use only

* For a list of compatible dimmers, see www.occhio.com/dim_en

Sento filo up pro overview inserts

single-sided head				
spot lens				
satinised glass (optional)				
soft edge glass (optional)				
fresnel lens				
color filter (optional, power of light source max. 18 W)				
diffuser glass				
lens				
				
	Sento B	Sento C	Sento S30	Sento S40
lens				
diffuser glass				
color filter (optional, power of light source max. 18 W)				
soft edge glass (optional)				
satinised glass (optional)				
double-sided head				
satinised glass (optional)				
soft edge glass (optional)				
color filter (optional, power of light source max. 18 W)				
diffuser glass				
lens				
				
		Sento A	Sento D	Sento E

Sento filo up pro lighting effects

 head single sided

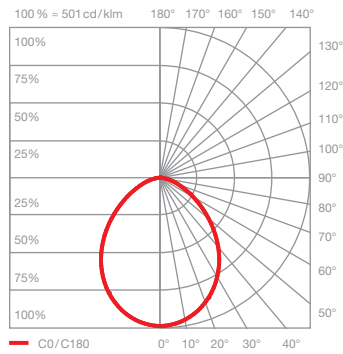
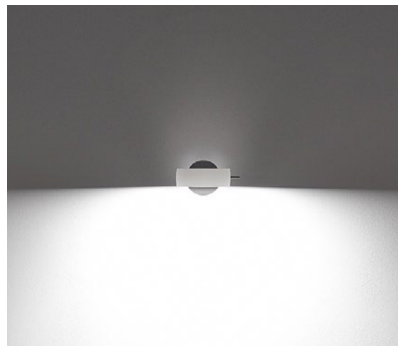

Sento B

diffuse light

insert: diffusor glass

luminous flux: perfect color 26 W 1370lm
high flux 26 W 1870lm

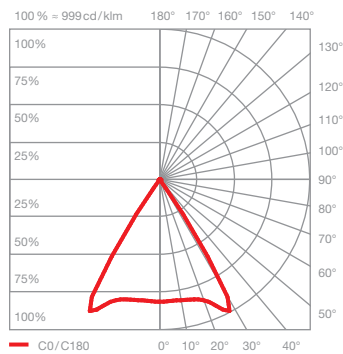

Sento C

directed light
beam angle approx. 80°

insert: lens
luminous flux: perfect color 26 W 1570lm
high flux 26 W 2150lm

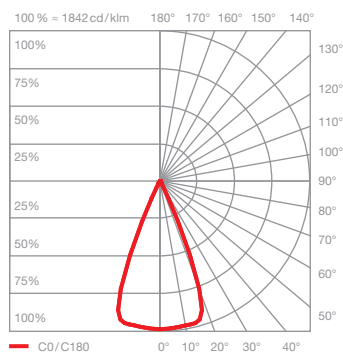
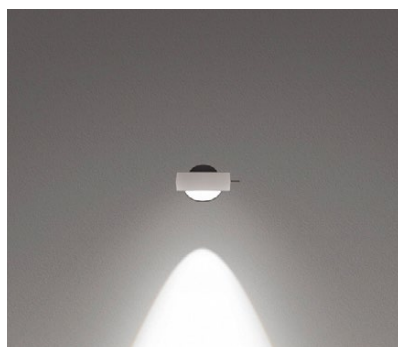

Sento S40

directed light
beam angle approx. 40°

insert: spot lens, lens
soft edge glass

luminous flux: perfect color 26 W 1560lm
high flux 26 W 2130lm

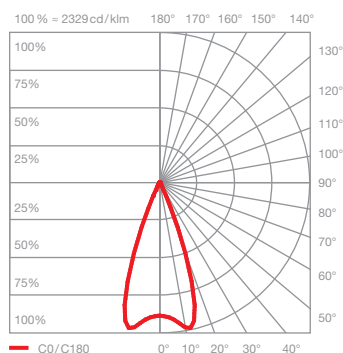

Sento S30

directed light
beam angle approx. 30°

insert: spot lens, lens
fresnel lens

luminous flux: perfect color 26 W 1530lm
high flux 26 W 2080lm

Sento filo up pro lighting effects

 head double sided

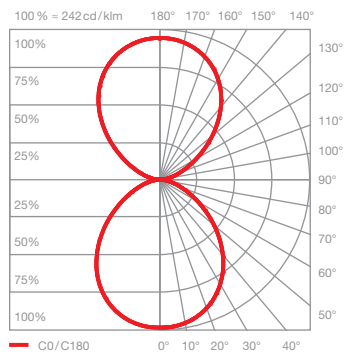
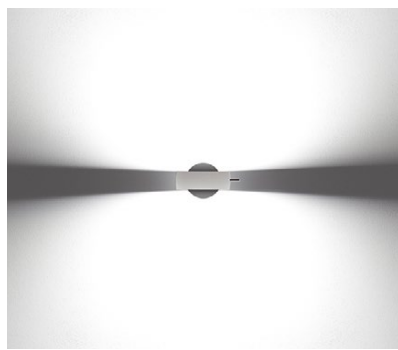

Sento A

diffuse light in both directions

insert: diffuser glass
diffuser glass

luminous flux: perfect color 26 W 1500lm
high flux 26 W 2040lm

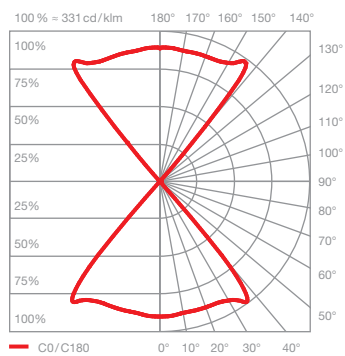

Sento D

directed light in both directions
beam angle approx. 80°

insert: lens
lens

luminous flux: perfect color 26 W 1750lm
high flux 26 W 2390lm

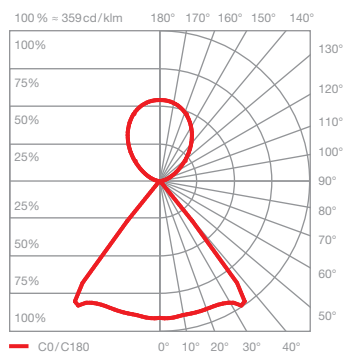
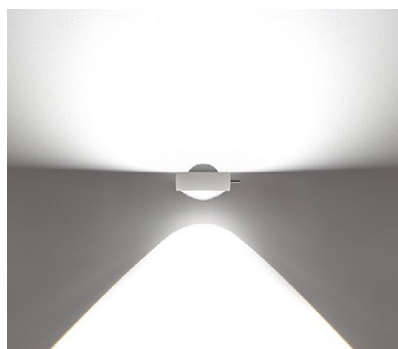

Sento E

diffuse up light
directed down light
beam angle approx. 80°

insert: diffuser glass
lens

luminous flux: perfect color 26 W 1620lm
high flux 26 W 2200lm