

Sento verticale up pro Datenblatt

LED Wandleuchte mit hoher base inkl. Occhio-Treiber für Montage auf fester Wand, Anschluß an 230 V. Modulares LED-Kopf-Körper-System ermöglicht freie Kombination verschiedener Oberflächen von head, body und base. Head für Konfiguration und Wartungszwecke abnehmbar, LED wechselbar (2700 K/3000 K/4000 K). Heads mit einseitigem oder beidseitigem Lichtaustritt erhältlich, Lichtleistung 26 W.

Lichtwirkung über optionale inserts veränderbar, dichroitische Farbfilter zusätzlich einsetzbar. Verstellmöglichkeit über wärmeentkoppelten Karbongriff. Head optional gegen Verdrehen fixierbar.

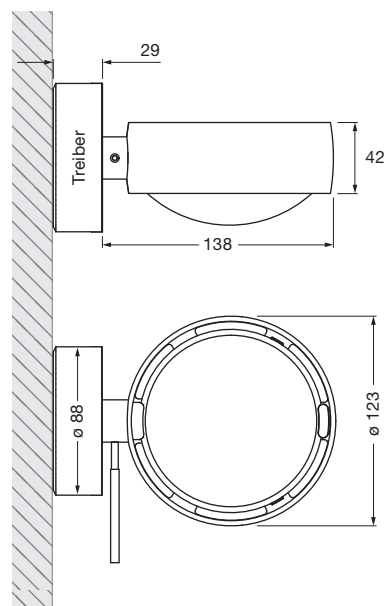













































Maße in mm

technische Daten Sento verticale up pro

Eigenschaften	Material	Aluminium, Stahl verchromt, lackiert oder eloxiert, Kunststoff, Glas, optischer Kunststoff
	Länge	138 mm inkl. Leuchtenkopf
	Beweglichkeit head	360°
	Gewicht	1,4 kg
Oberfläche	head	gold matt, rose gold, bronze, chrom glanz, chrom matt, weiß glanz, weiß matt, schwarz matt, phantom, black phantom
	body	weiß matt, schwarz matt, chrom glanz, chrom matt
	base	chrom glanz, weiß glanz, chrom matt, weiß matt, schwarz matt
Occhio LED	mittlere Lebensdauer	> 50.000 Std.
	Energieeffizienzklasse (Lichtausbeute)	G (head einseitig 66 lm / W, head beidseitig 73 lm / W)
	Leistung einseitig/beidseitig	LED 26 W max. 700 mA (> 36 DC) / max. 2 x 350 mA (> 36 DC)
	Farbwiedergabeindex	perfect color; CRI Ra 97 high flux; CRI Ra 85
	Farbtemperatur	2700, 3000 K, 4000 K 3000, 3500, 4000 K
Elektrik	Dimmung	via Phasenabschrittdimmer*
	Vorschaltgerät	integriert, Betrieb an 230 V AC
	zulässige Betriebsbedingung	max. 30°C nur im Innenbereich betreiben

* Liste kompatibler Dimmer: www.occhio.com/dim

Sento verticale up pro Übersicht inserts

head einseitig				
spot Linse				
satiniertes Glas (optional)				
soft edge Glas (optional)				
Fresnel Linse				
Farbfilter (optional, Lichtleistung max. 18 W)				
Diffusorglas				
Linse				
				
	Sento B	Sento C	Sento S30	Sento S40
Linse				
Diffusorglas				
Farbfilter (optional, Lichtleistung max. 18 W)				
soft edge Glas (optional)				
satiniertes Glas (optional)				
head beidseitig				
satiniertes Glas (optional)				
soft edge Glas (optional)				
Farbfilter (optional, Lichtleistung max. 18 W)				
Diffusorglas				
Linse				
				
		Sento A	Sento D	Sento E

Sento verticale up pro Lichtwirkungen

 head einseitig

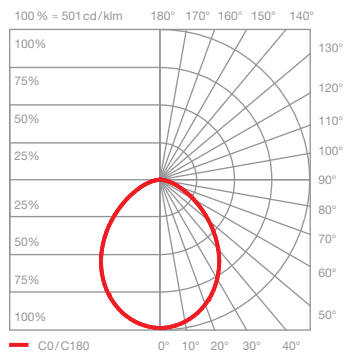
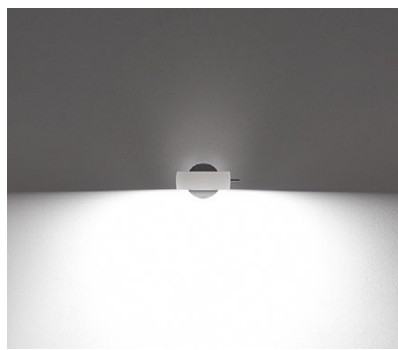

Sento B

diffuses Licht

insert: Diffusorglas

Lichtstrom: perfect color 26 W 1370lm
high flux 26 W 1870lm

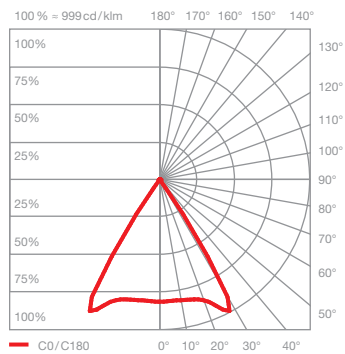

Sento C

gerichtetes Licht
Lichtkegel ca. 80°

insert: Linse

Lichtstrom: perfect color 26 W 1570lm
high flux 26 W 2150lm

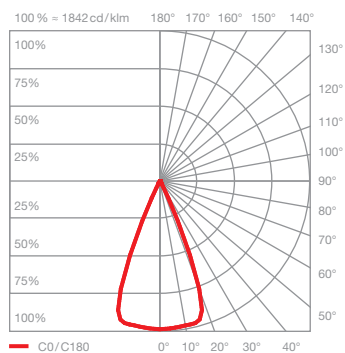
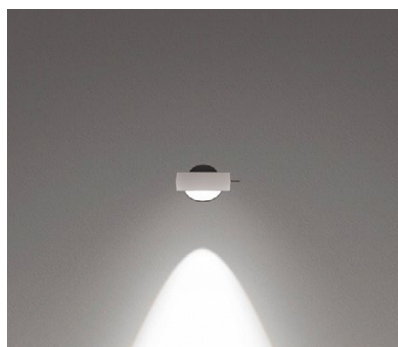

Sento S40

gerichtetes Licht
Lichtkegel ca. 40°

insert: Doppellinse
soft edge Glas

Lichtstrom: perfect color 26 W 1560lm
high flux 26 W 2130lm

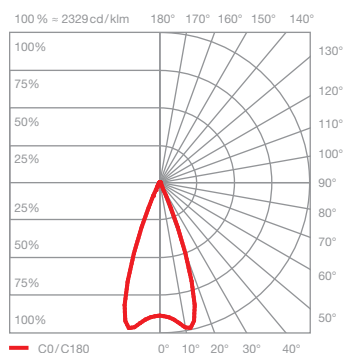

Sento S30

gerichtetes Licht
Lichtkegel ca. 30°

insert: Doppellinse
Fresnellinse

Lichtstrom: perfect color 26 W 1530lm
high flux 26 W 2080lm

Sento verticale up pro Lichtwirkungen

 head beidseitig

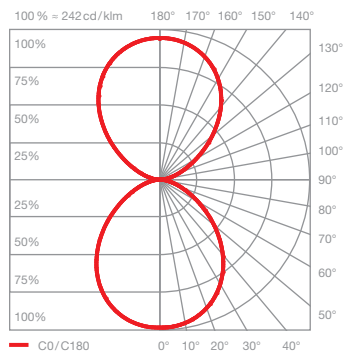
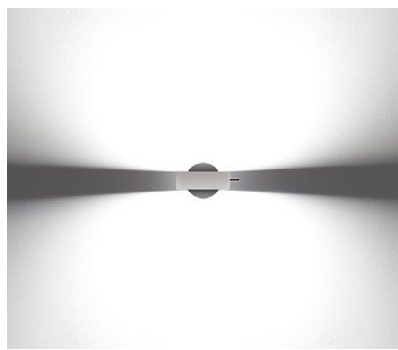

Sento A

diffuses Licht in beide Richtungen

insert: Diffusorglas
 Diffusorglas

Lichtstrom: perfect color 26 W 1500lm
 high flux 26 W 2040lm

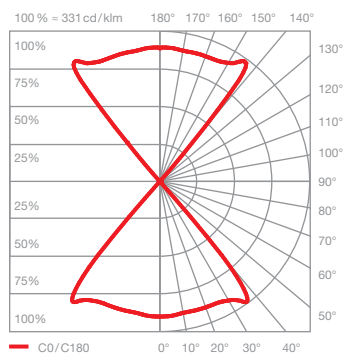

Sento D

gerichtetes Licht in beide Richtungen
Lichtkegel ca. 80°

insert: Linse
 Linse

Lichtstrom: perfect color 26 W 1750lm
 high flux 26 W 2390lm

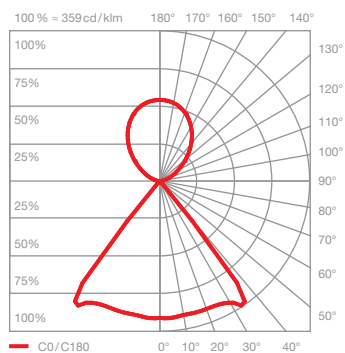
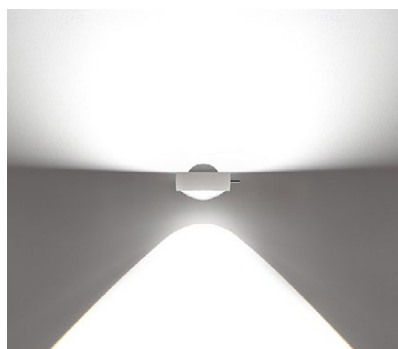

Sento E

diffuses Licht nach oben
gerichtetes Licht nach unten
Lichtkegel ca. 80°

insert: Diffusorglas
 Linse

Lichtstrom: perfect color 26 W 1620lm
 high flux 26 W 2200lm