

Più alto 3d track VOLT datasheet

LED ceiling spotlight with single-sided light output. Optionally available with lens optics (Più) or flat cone glass with internal lens (Più R).

Connection to 230V AC/50 Hz mains voltage. Dimmable via trailing-edge phase-cut dimmer*. Movable in any direction thanks to Occhio 3D kinematics with two pivots set at an angle of 45° to each other. Using a simple mechanism, the lighting effect can be changed at any time through the use of optional inserts, dichroitic colour filter can be additionally inserted, VOLT light engine replaceable.

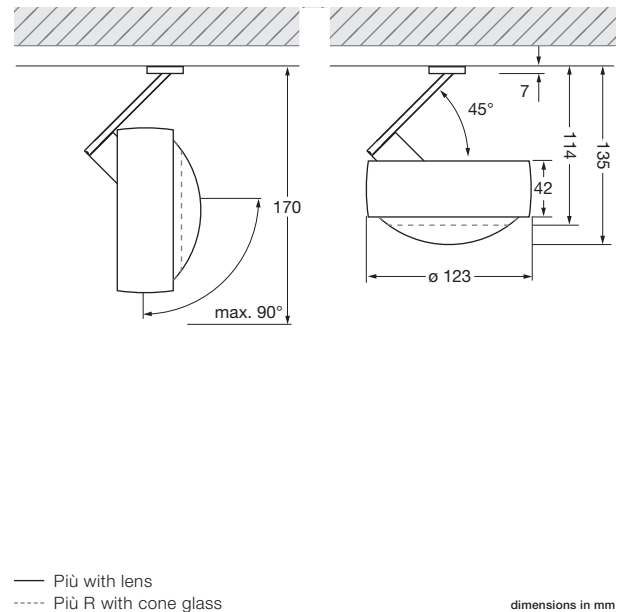

technical data Più alto 3d track VOLT

properties	material	aluminium, brass, steel – chrome-plated or painted, optical plastic, glass
	turning range body	360° (with stop)
	turning range head	360° (with stop)
	weight	1.1 kg
surface	head	matt gold, rose gold, bronze, shiny chrome, matt chrome, glossy white, matt white, matt black, phantom, black phantom
	body	shiny chrome, matt chrome, matt white, matt black
	track adapter	white, silver, black
	lens	matt white, matt black (lens edge)
	cone glass	rose gold, bronze, shiny chrome, matt chrome matt white, matt black, phantom, black phantom
VOLT light engine	average life time	> 40.000 hrs
	energy efficiency class (luminous efficiency)	G (58 lm / W)
	power	LED 26 W (switchable 26 W / 18 W / 13 W)
	color rendering index	perfect color; CRI Ra 97
	color temperature (color consistency)	2700 K, 3000 K (2-step)
electricity	dimming	by trailing-edge phase-cut dimmer*
	connection	operation at 230V AC/50 Hz
	power factor power supply (cos φ1)	0.9
	flicker / stroboscopic effect	1 (PstLM) / 0.9 (SVM)
	permitted operating conditions	max. 30°C for indoor use only

* For a list of compatible dimmers, see www.occhio.com/dim_en

Più alto 3d track VOLT overview optics

Più	C 80	S 100	S 80	S 60	S 40	S 30		
small lens low								
small lens medium								
satinised glass								
soft edge glass								
fresnel lens								
color filter (optional)								
lens								
Più R	B	C 100	C 80	S 100	S 80	S 60	S 40	S 30
small lens low								
small lens medium								
small lens high								
satinised glass								
soft edge glass								
fresnel lens								
color filter (optional)								
cone glass								
	diffus	100°, contour	80°, contour	100°, soft	80°, soft	60°, soft	40°, soft	30°, soft

Più alto 3d track VOLT Più lighting effects

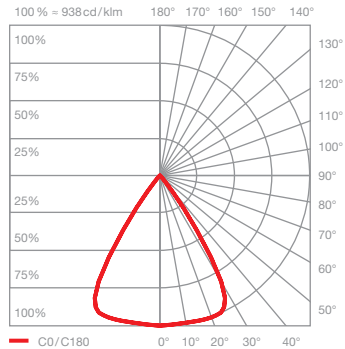
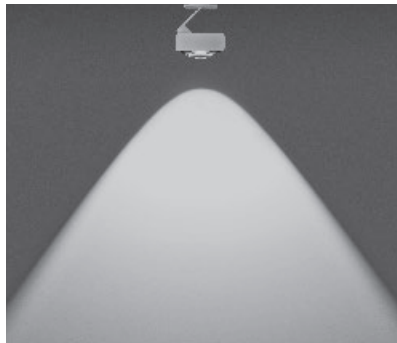

C 80 contour

scattered light with contour beam angle
(approx. 80°)

inserts: lens

luminous flux:	perfect color	26 W	1290 lm
	perfect color	18 W	970 lm
	perfect color	13 W	730 lm

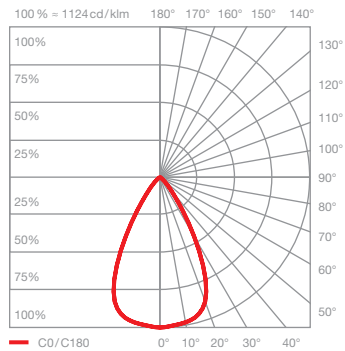
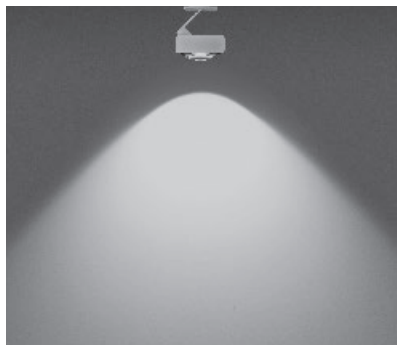

S 100 soft

scattered light with soft contour beam angle
(approx. 100°)

inserts: lens
satinised glass

luminous flux:	perfect color	26 W	1030 lm
	perfect color	18 W	780 lm
	perfect color	13 W	580 lm

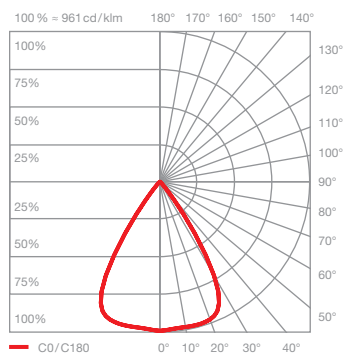
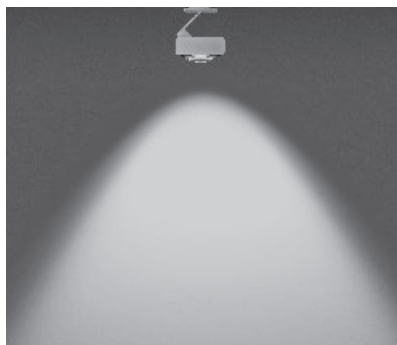

S 80 soft

scattered light with soft contour beam angle
(approx. 80°)

inserts: lens
soft edge glass

luminous flux:	perfect color	26 W	1140 lm
	perfect color	18 W	860 lm
	perfect color	13 W	640 lm

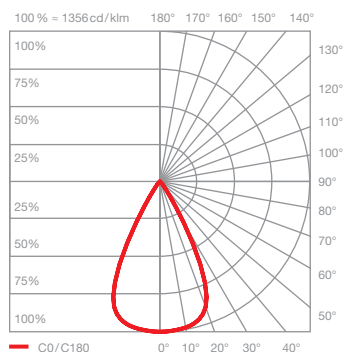
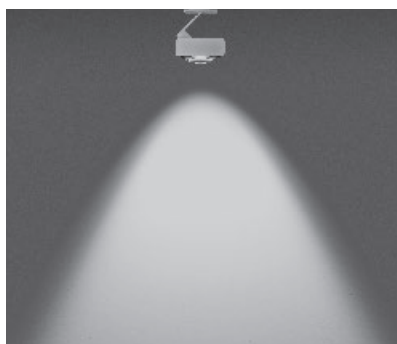

S 60 soft

scattered light with soft contour beam angle
(approx. 60°)

inserts: lens
small lens low
soft edge glass

luminous flux:	perfect color	26 W	1240 lm
	perfect color	18 W	930 lm
	perfect color	13 W	700 lm

Più alto 3d track VOLT Più lighting effects

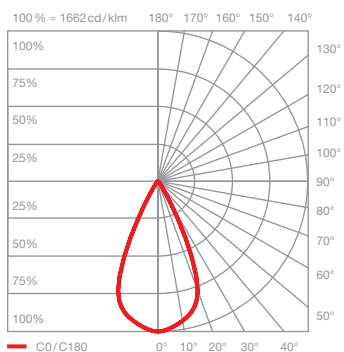
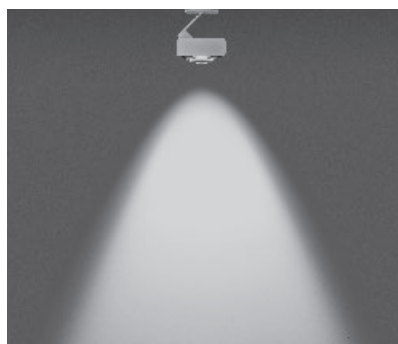

S40 soft

scattered light with soft contour beam angle (approx. 40°)

inserts: lens
small lens medium
soft edge glass

luminous flux: perfect color 26W 1280lm
perfect color 18W 960lm
perfect color 13W 720lm

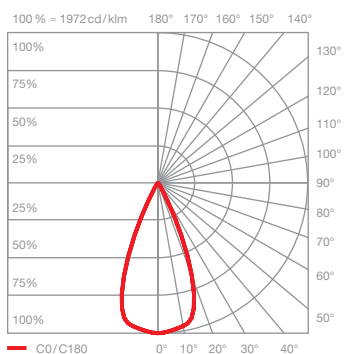

S30 soft

scattered light with soft contour beam angle (approx. 30°)

inserts: lens
small lens medium
fresnel lens

luminous flux: perfect color 26W 1270lm
perfect color 18W 950lm
perfect color 13W 710lm

Più alto 3d track VOLT Più R lighting effects

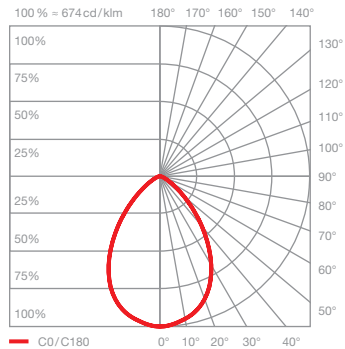

B diffus diffused light

inserts: cone glass
small lens low
satinised glass

luminous flux: perfect color 26 W 1200 lm
perfect color 18 W 900 lm
perfect color 13 W 680 lm

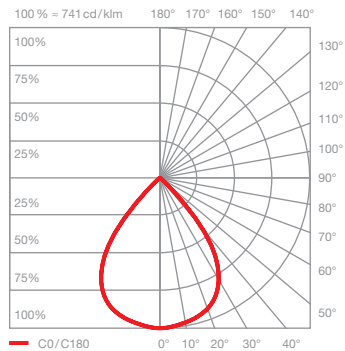
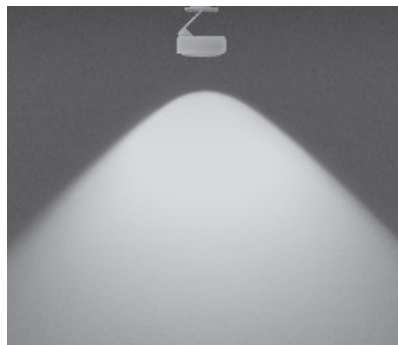

C 100 contour scattered light with contour beam angle (approx. 100°)

inserts: cone glass
small lens low

luminous flux: perfect color 26 W 1340 lm
perfect color 18 W 1000 lm
perfect color 13 W 750 lm

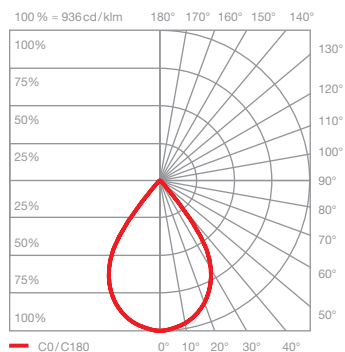
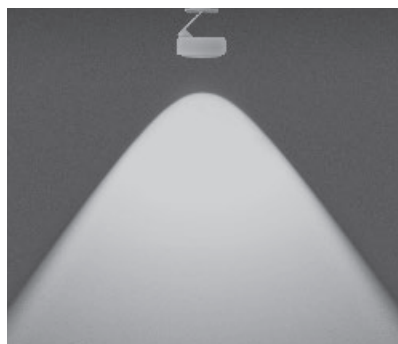

C 80 contour scattered light with contour beam angle (approx. 80°)

inserts: cone glass
small lens medium

luminous flux: perfect color 26 W 1400 lm
perfect color 18 W 1050 lm
perfect color 13 W 790 lm

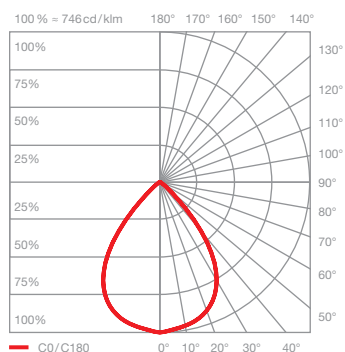
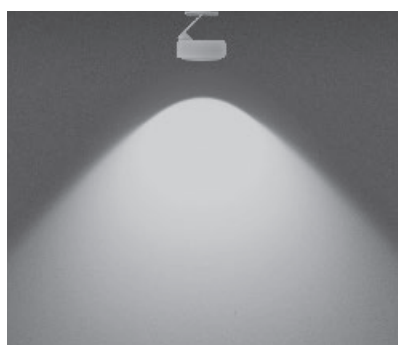

S 100 soft scattered light with soft contour beam angle (approx. 100°)

inserts: cone glass
small lens low
soft edge glass

luminous flux: perfect color 26 W 1210 lm
perfect color 18 W 910 lm
perfect color 13 W 680 lm

Più alto 3d track VOLT Più R lighting effects

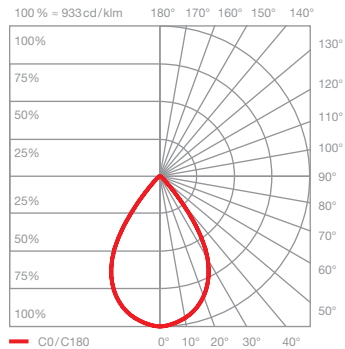
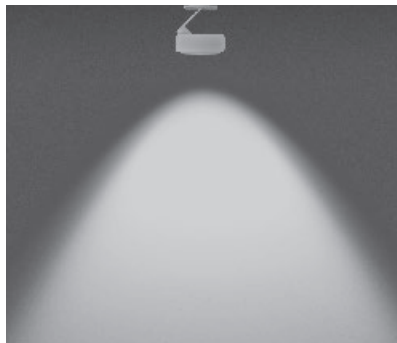

S80 soft

scattered light with soft contour beam angle (approx. 80°)

inserts: cone glass
small lens medium
soft edge glass

luminous flux: perfect color 26 W 1250 lm
perfect color 18 W 940 lm
perfect color 13 W 710 lm

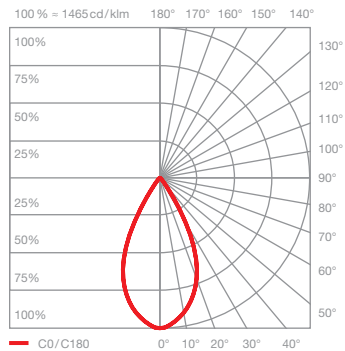
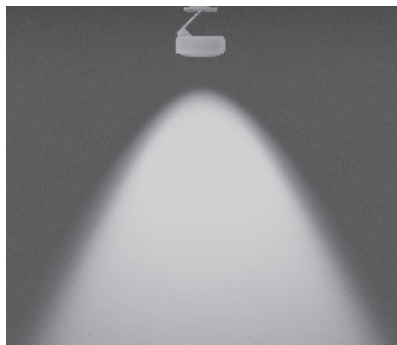

S60 soft

scattered light with soft contour beam angle (approx. 60°)

inserts: cone glass
small lens high
soft edge glass

luminous flux: perfect color 26 W 1220 lm
perfect color 18 W 920 lm
perfect color 13 W 690 lm

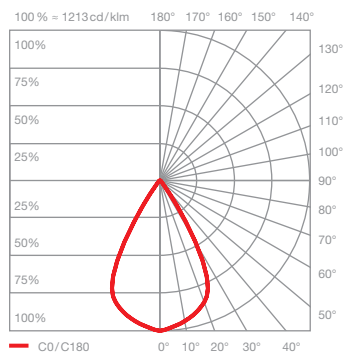
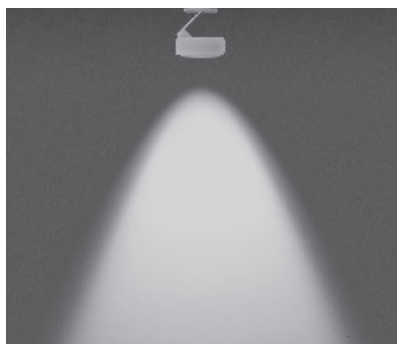

S40 soft

scattered light with soft contour beam angle (approx. 40°)

inserts: cone glass
small lens medium
fresnel lens

luminous flux: perfect color 26 W 1220 lm
perfect color 18 W 920 lm
perfect color 13 W 690 lm

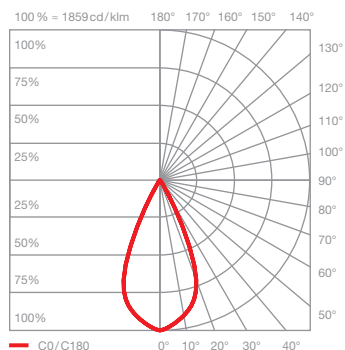

S30 soft

scattered light with soft contour beam angle (approx. 30°)

inserts: cone glass
small lens high
fresnel lens

luminous flux: perfect color 26 W 1250 lm
perfect color 18 W 940 lm
perfect color 13 W 700 lm