

clipLED module Puro A,D,E datasheet

LED replacement module for halogen light source in Puro HV halogen luminaires with double-sided light output. clipLED module can be installed in an existing Puro HV head without tools.

B15d adapter for mounting on Puro HV body included. Connection to 230 V/50 Hz mains voltage and externally dimmable via phase cut dimmer.

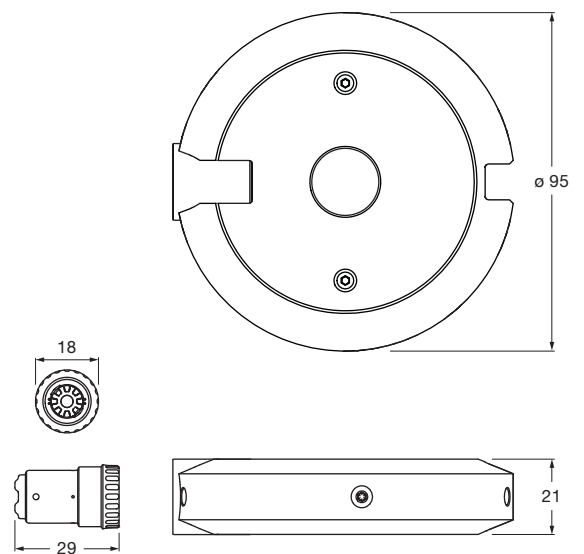

dimensions in mm

technical data clipLED module Puro A,D,E

properties	material	aluminum, copper beryllium, polyamide, glass, steel
	weight	180 g
clipLED	average life time	25.000 hrs
	energy efficiency class (luminous efficiency)	F (head single-sided 68 lm/W)
	power	LED 12 W
	color rendering index	CRI 95
electricity	color temperature (color consistency)	2700 K (3-step)
	dimming	via trailing-edge phase cut dimmer
	connection	220 – 240 V AC / 50 Hz
	power factor power supply (cos ϕ 1)	> 0.9
	flicker / stroboscopic effect	< 1 (PstLM) / < 0.4 (SVM)
permitted operating conditions	max. 30°C for indoor use only	

clipLED module Puro A,D,E lighting effects

 head double sided

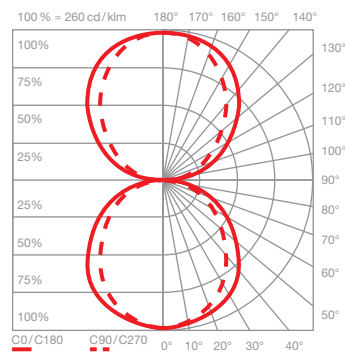
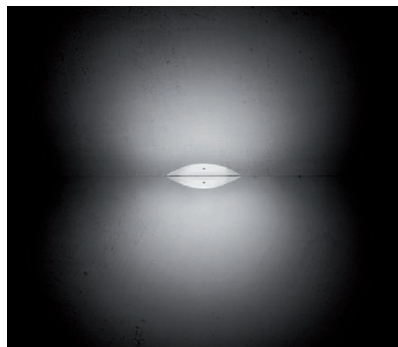

Puro A

diffuse light

insert: satinised glass
satinised glass

luminous flux:
clipLED 12 W 1000 lm*
B15d 70 W 890 lm**

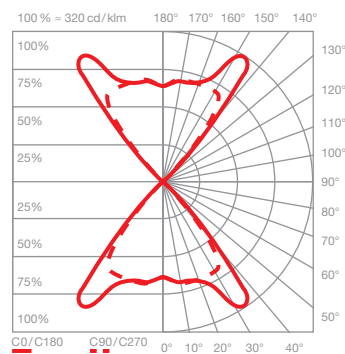
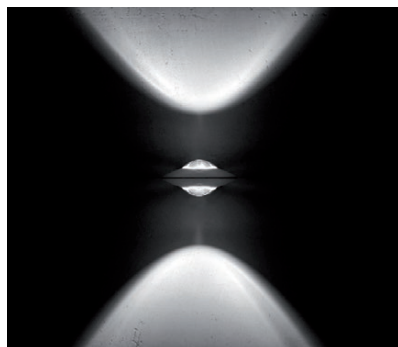

Puro D

directed light

insert: lens
lens

luminous flux:
clipLED 12 W 1050 lm*
B15d 70 W 880 lm**

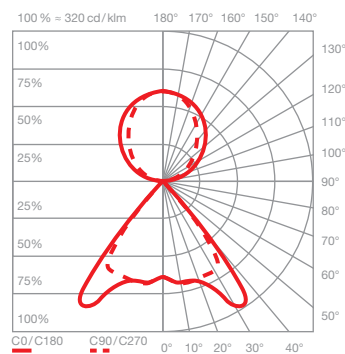
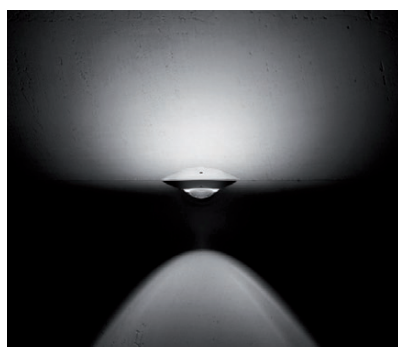

Puro E

diffuse light
directed light
beam angle approx. 65° (down)

insert: satinised glass
lens

luminous flux:
clipLED 12 W 1000 lm*
B15d 70 W 870 lm**

* built into luminaire head with inserts
** five bulbs 70 W HV halogen clear measured and value averaged

clipLED module Puro A,D,E accessories

long B15D adapter

for luminaires from Occhio with short socket

Article can be reordered free of charge in the partner portal.

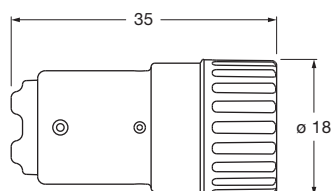

For shorter socket (< 28 mm) a long adapter is required.

