

Mito cosmo piano 40 datasheet

A ring-shaped recessed ceiling luminaire with double-sided light output and a diameter of 40 cm. There are two lighting effects to choose from: table (wide) for use above tables – expansive, glare-free light that is cast downwards and diffuse light pointed upwards (glowlight) – and room (narrow) as room luminaires to ensure perfect illumination for every use – concentrated, glare-free light aimed downwards and diffuse light pointed upwards (glowlight).

The luminaire head is set completely in the light channel that is flush with the ceiling. Version with plastering element and light channel for installation flush with the ceiling in hollow space ceilings, incl. power supply unit, connection to 230 V AC power supply. Controllable via Occhio air. The color temperature is continuously variable via Occhio air between 2700 – 4000 K (optional 2200 – 3500 K).

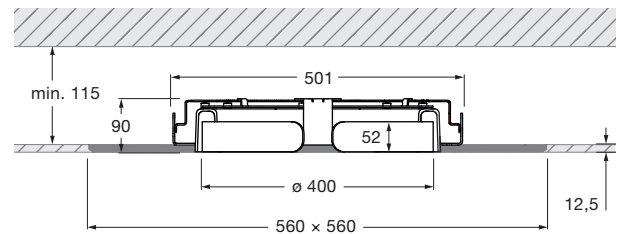
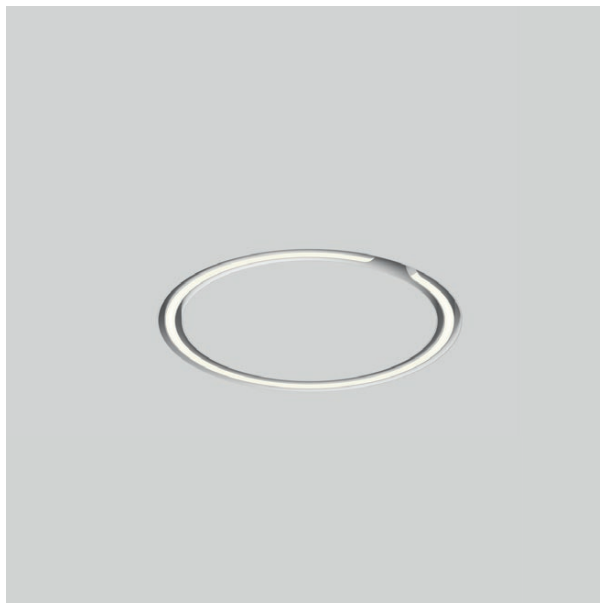

* cut-out dimensions mounting plate
incl. power supply unit (removable)

dimensions in mm

technical data Mito cosmo piano 40

properties	material	aluminium, painted, PVD-coated steel, plastic, optical silicone, fibreglass
	weight (luminaire + mounting plate)	3.3 kg + 7.3 kg
surface	head	bronze, matt gold, rose gold, matt silver, matt white, matt black, phantom, black phantom
	light channel	matt white, matt gold
Occhio »color tune« LED	average life time	> 50.000 hrs
	energy efficiency class (luminous efficiency)	G (43 lm / W)
	power	LED 40 W (incl. Occhio power supply unit 45 W, standby < 0.5 W)
	color rendering index	high color; CRI Ra 95
	color temperature (color consistency)	2700–4000 K (2-step) 2200–3500 K (2-step 2200 K, 3-step 3500 K)
electricity	dimming	Occhio air
	connection	120–240 V AC
	power factor power supply (cos φ1)	0.94
	flicker / stroboscopic effect	< 1 (PstLM) / 0.4 (SVM)
	permitted operating conditions	max. 30°C for indoor use only

*For a list of compatible dimmers, see www.occhio.com/dim_en

Mito cosmo piano 40 Support structure

The special substructure must be taken into account during planning due to the weight of the luminaire and should not deviate from the specified dimensions.

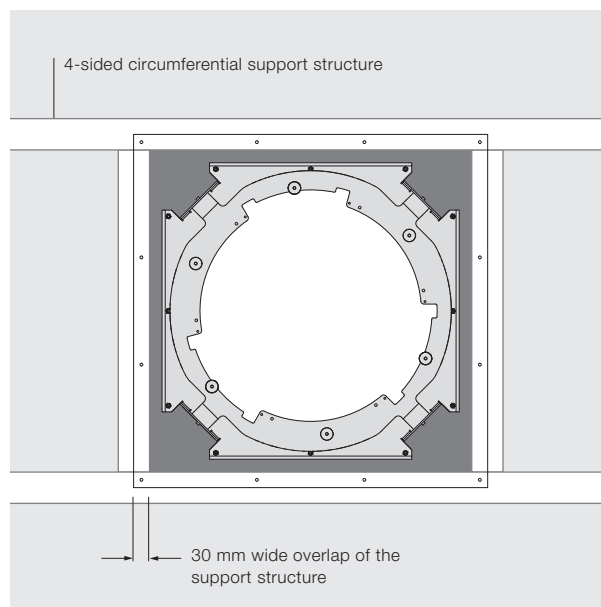

top view

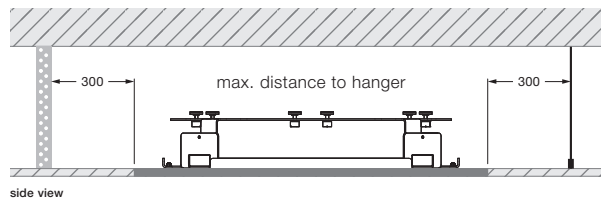

Mito cosmo piano 40 lighting effects

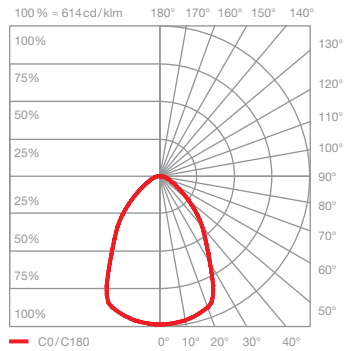
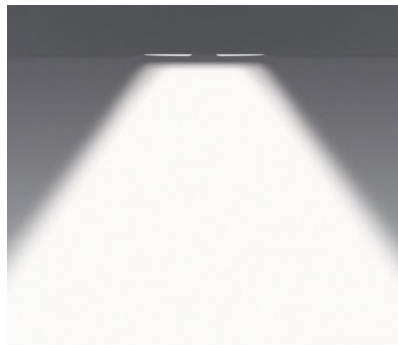

table (wide)

expansive light distributed downwards, light cone about 80° diffuse light pointed upwards (glowlight)

inserts: wide (down) / glow (up)

luminous flux : high color 40 W 1700 lm

UGR (4H8H) < 19*

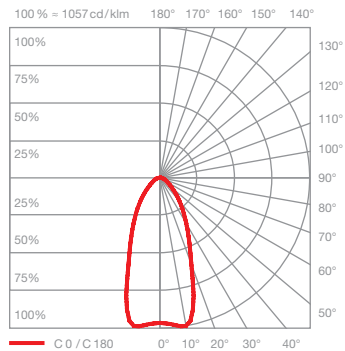
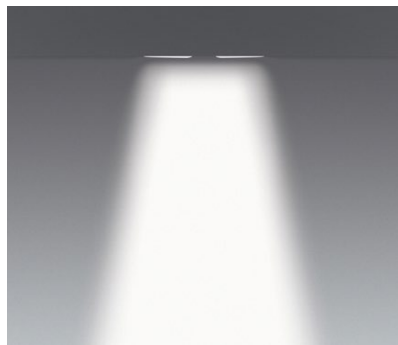

room (narrow)

concentrated light distributed downwards, light cone about 50° diffuse light pointed upwards (glowlight)

inserts: wide (down) / glow (up)

luminous flux : high color 40 W 1440 lm

UGR (4H8H) < 19*

*The standardized indication of glare values (UGR value – 4H8H) is not quite significant for annular luminaires. In most real applications the result of an individual calculation is a UGR value < 19. Therefore, we recommend to carry out a calculation which can be prepared by our lighting design team (project-support@occhio.de).