

Mito volo 100 pro acoustic datasheet

Square acoustic panel measuring 150 × 100 cm to mount directly on the ceiling or suspend using wire cable (maximum of 200 cm). The enhanced indirect lighting — augmented by the exchangeable stretch material — gives the room a more pleasant light. The polyester fleece panel offers excellent sound absorption qualities that significantly reduce reverberation time in the room, thus improving the acoustics there. Creating a new visual layer also makes it possible to give the room a different look without having to resort to a suspended ceiling.

The panel is suitable for the linear LED pendant luminaire Mito volo 100 with double-sided light output. There are two lighting effects to choose from: table (wide) for use above tables — expansive light distributed downward and upward — and room (narrow) for luminaires that hang by themselves in a room — concentrated light aimed downward and diffuse light pointed upward. The maximum pendulum length is 350 cm (adjustable during installation). The color temperature is selectable at purchase (2700, 3000 or 4000 kelvins).

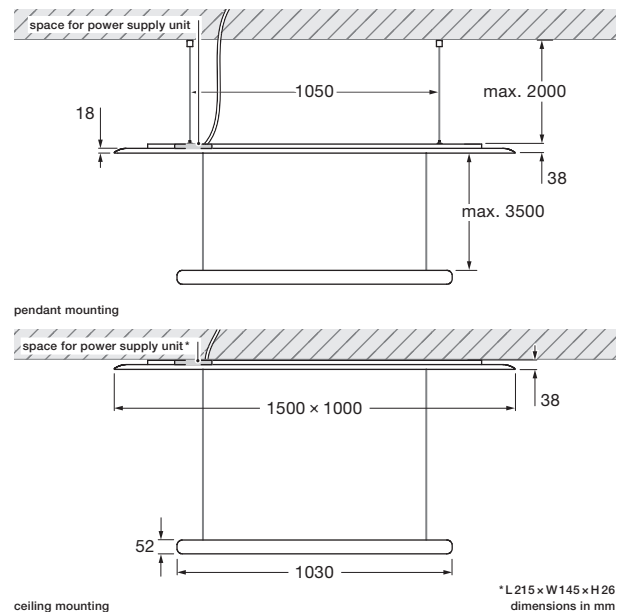

technical data Mito volo 100 pro acoustic

properties	material	polyester fleece, aluminium, painted, PVD-coated steel, optical plastic
	degree of absorption panel	0.85 α
	height setting panel / luminaire	max. 2000 mm / max. 3500 mm (can be adjusted during fitting)
	weight panel / luminaire	7 kg / 2.5 kg
surface	head	bronze, matt gold, rose gold, matt silver, matt white, matt black, phantom, black phantom
	panel	white
	wire suspension	matt white, matt black
Occhio LED	average life time	> 50.000 hrs
	energy efficiency class (luminous efficiency)	G (70 lm / W)
	power	LED 45 W
	color rendering index	high color; CRI Ra 95
	color temperature	2700 K, 3000 K, 4000 K
electricity	dimming	with suitable power supply unit
	connection	max. 1600 mA const. / > 32 VDC (up + down together controllable) max. 2 × 800 mA const. / > 32 VDC (up + down separately controllable)
	permitted operating conditions	max. 30°C for indoor use only

Mito volo 100 pro acoustic accessories

Cable box incl. 3-pin cable or optionally with 5-pin cable for DALI, connection to 230VAC/50Hz mains voltage.

surface matt white, matt black
cable length 2 m

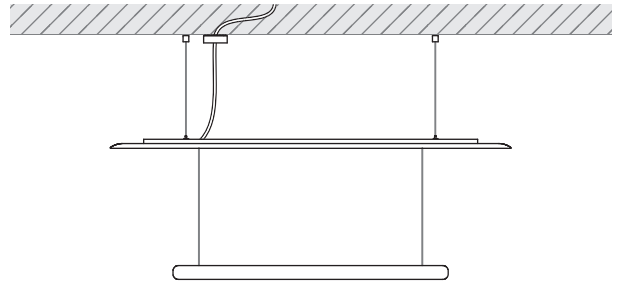

Trac adapter for 3-phase Erco-, Zumtobel- or Eutrac-bus-bar, connection to 230VAC/50Hz mains voltage (DALI optional only Eutrac).

surface matt white, matt black
cable length 2 m

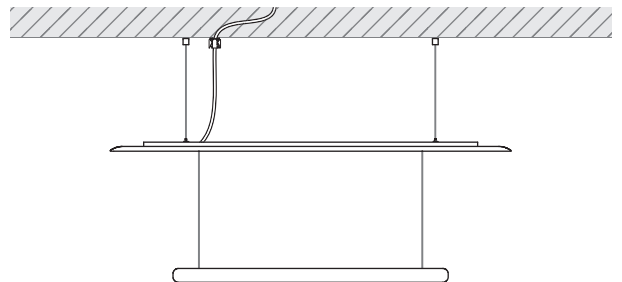

Mito volo 100 pro acoustic lighting effects

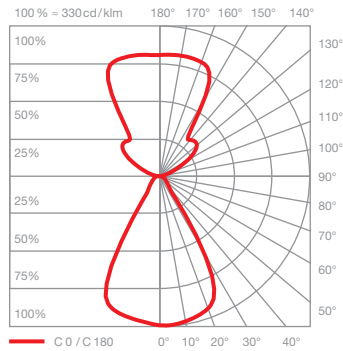
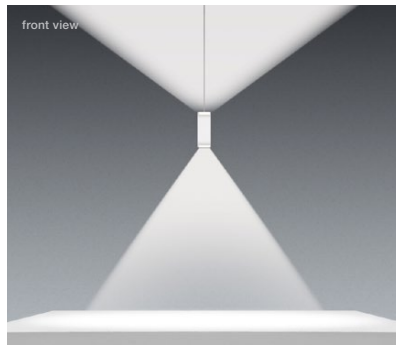

table (wide)

wide light beam (up and down), beam angle approx. 80° (down)

inserts: wide / flood

luminous flux: high color 45 W 2900 lm

UGR (4H8H) < 19*

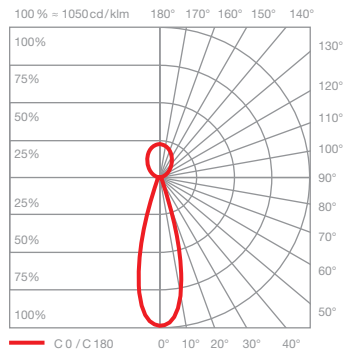
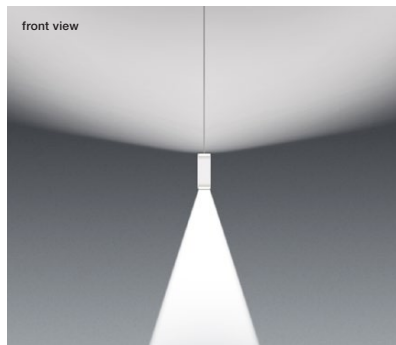
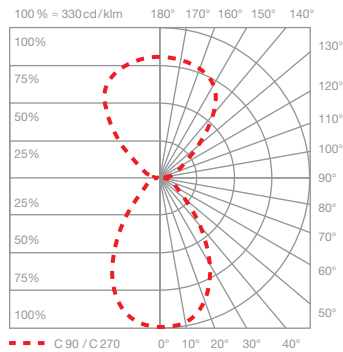
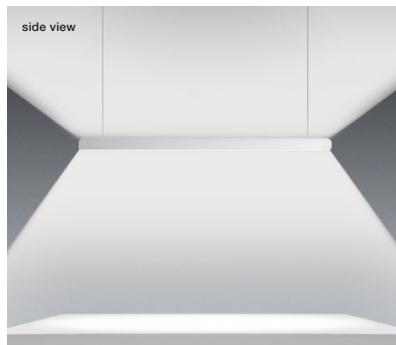

room (narrow)

concentrated light downwards, beam angle approx. 25°, diffuse upwards

inserts: narrow / diffuse

luminous flux: high color 45 W 2800 lm

UGR (4H8H) < 19*

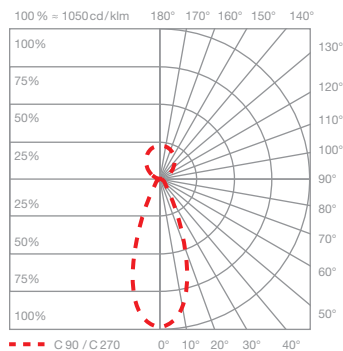
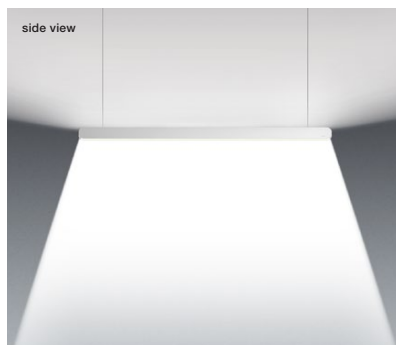

*For a reliable assessment of glare values in a real application of a luminaire we recommend to carry out an individual calculation which can be prepared by our lighting team (project-support@occhio.de).