

Mito volo 100 acoustic datasheet

Square acoustic panel measuring 150 × 100 cm to mount directly on the ceiling or suspend using wire cable (maximum of 200 cm). The enhanced indirect lighting — augmented by the exchangeable stretch material — gives the room a more pleasant light. The polyester fleece panel offers excellent sound absorption qualities that significantly reduce reverberation time in the room, thus improving the acoustics there. Creating a new visual layer also makes it possible to give the room a different look without having to resort to a suspended ceiling. The panel is suitable for the linear LED pendant luminaire Mito volo 100 with double-sided light output. There are two lighting effects to choose from: table (wide) for use above tables — expansive light distributed downward and upward — and room (narrow) for luminaires that hang by themselves in a room — concentrated light aimed downward and diffuse light pointed upward. The maximum pendulum length is 350 cm (adjustable during installation). The luminaire can be controlled with the help of »touchless control« (gesture control on the head), Occhio air or DALI, or, alternatively, dimmed with a trailing-edge phase cut dimmer.* To be connected to 230-volt AC power supply; see connection accessories. The color temperature is infinitely variable between 2700 and 4000 kelvins using »touchless control«, Occhio air or DALI or with preset values (2700, 3000, 3500 or 4000 kelvins).

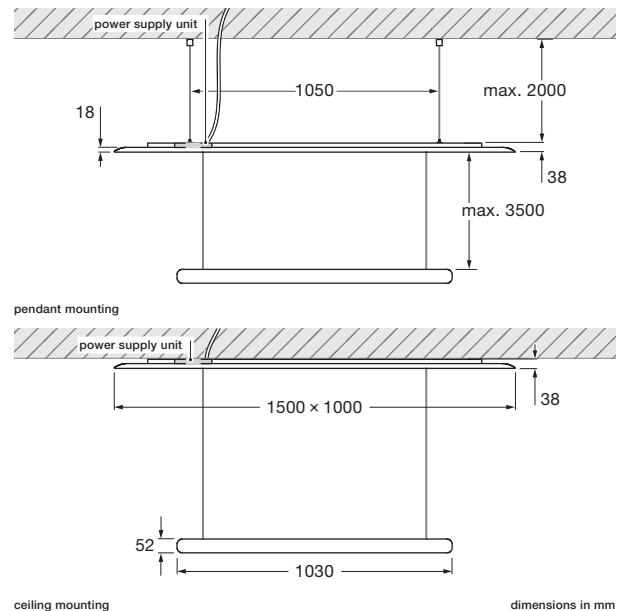

technical data Mito volo 100 acoustic

properties	material	polyester fleece, aluminium, painted, PVD-coated steel, optical plastic
	degree of absorption panel	0.85 α
	height setting panel / luminaire	max. 2000 mm / max. 3500 mm (can be adjusted during fitting)
	weight panel / luminaire	7 kg / 2.5 kg
surface	head	bronze, matt gold, rose gold, matt silver, matt white, matt black, phantom, black phantom
	panel	white
	wire suspension	matt white, matt black
Occhio »color tune« LED	average life time	> 50.000 hrs
	energy efficiency class (luminous efficiency)	G (66 lm / W)
	power	LED 45 W (incl. Occhio power supply unit approx. 52 W, standby < 0.5 W)
	color rendering index	high color; CRI Ra 95
	color temperature (color consistency)	2700–4000 K (2-step)
electricity	dimming	»touchless control«, Occhio air (optional), DALI or via trailing-edge phasecut dimmer*
	connection	230 V AC
	power factor power supply (cos φ1)	0.9
	flicker / stroboscopic effect	1 (PstLM) / 0.9 (SVM)
	permitted operating conditions	max. 30°C for indoor use only

* For a list of compatible dimmers, see www.occhio.de/dim_en, trailing-edge phasecut dimmer, »touchless control«, Occhio air and DALI not combinable

Mito volo 100 acoustic accessories

Cable box incl. 3-pin cable or optionally with 5-pin cable for DALI, connection to 230VAC/50Hz mains voltage.

surface matt white, matt black
cable length 2m

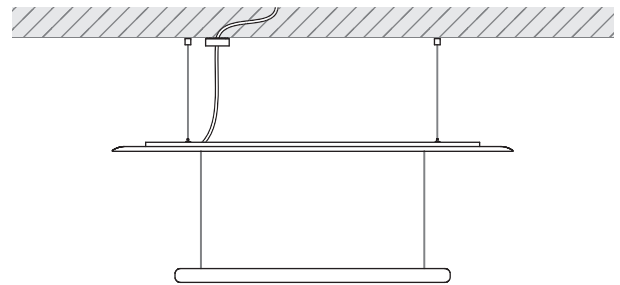

Trac adapter for 3-phase Erco-, Zumtobel- or Eutrac-bus-bar, connection to 230VAC/50Hz mains voltage (DALI optional only Eutrac).

surface matt white, matt black
cable length 2m

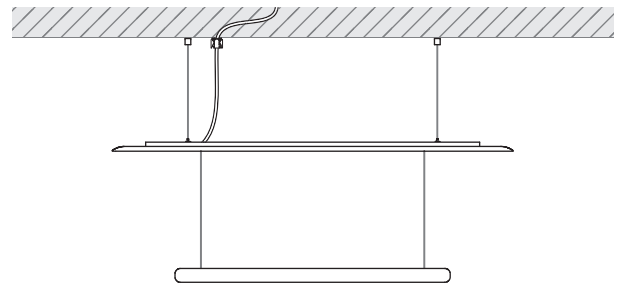

Mito volo 100 acoustic lighting effects

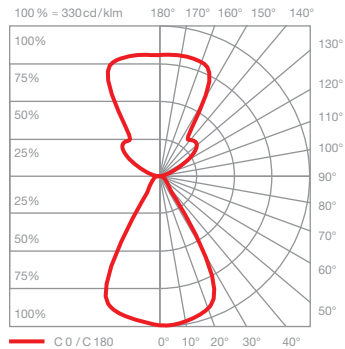
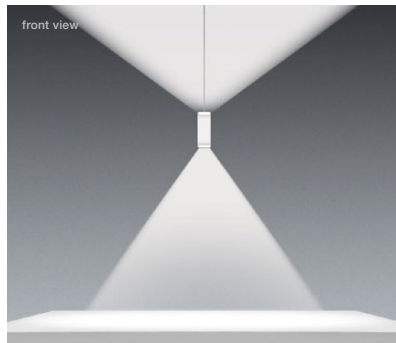

table (wide)

wide light beam (up and down), beam angle approx. 80° (down)

inserts: wide / flood

luminous flux: high color 45 W 2900 lm

UGR (4H8H) < 19*

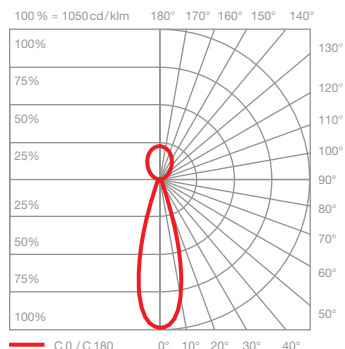
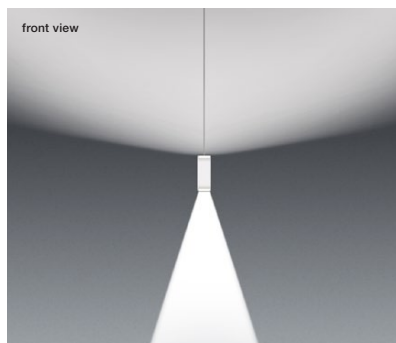
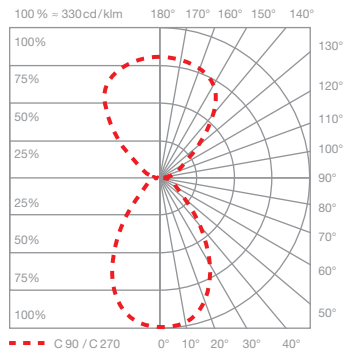
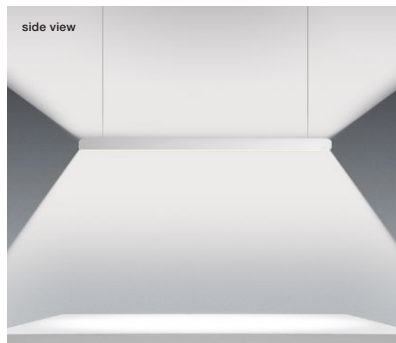

room (narrow)

concentrated light downwards, beam angle approx. 25°, diffuse upwards

inserts: narrow / diffuse

luminous flux: high color 45 W 2800 lm

UGR (4H8H) < 19*

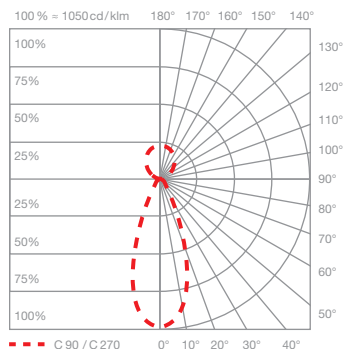
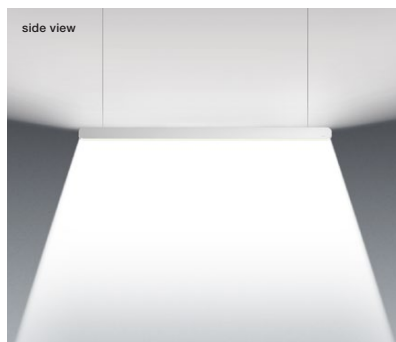

*For a reliable assessment of glare values in a real application of a luminaire we recommend to carry out an individual calculation which can be prepared by our lighting team (project-support@occhio.de).

control options

Control

Mito set box

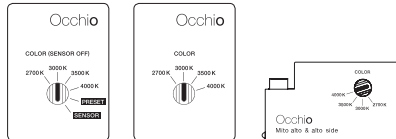

sospeso / aura / sfera / sfera su / volo

soffitto / alto flat

alto & alto side

sospeso / aura / sfera / volo:

COLOR (Sensor off)
adjustable color temperature (4 steps)
trailing-edge phase cut dimming possible

PRESET (sospeso / aura / volo)
adjustable color temperature (4 steps)
adjustable up / downlight ratio (5 steps)
trailing-edge phase cut dimming possible

PRESET (sfera)
color temperature adjustable (4 stages)
light intensity adjustable (5 stages)

SENSOR

»touchless control« (gesture control)
switching, dimming, up / down fading*
»color tune« (color temperature continuously adjustable)
no external dimming possible

*not with sfera

soffitto / alto / alto side:

COLOR
adjustable color temperature (4 steps)
trailing-edge phase cut dimming possible

Mito »air« box

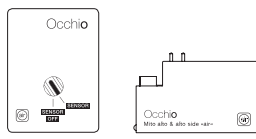

sospeso / aura / sfera / volo

alto & alto side



Occhio air (Bluetooth control using Occhio air app) or air controller (optional) control of individual luminaires, groups and scenes

sospeso / aura / sfera / volo:

SENSOR
»air« + »touchless control« (Bluetooth- and gesture control)
control via »touchless control« and Occhio air app or »air« controller

SENSOR OFF

»air«
control via Occhio air App or »air« controller
switching, dimming, up / down fading »color tune« (color temperature continuously adjustable)



terra / raggio / largo / soffitto / alto flat

terra / largo / raggio:

»air«, »touchless control« and »body sensor« (raggio / terra) (Bluetooth- and gesture control)
control via »touchless control«, »body sensor« and Occhio air App or »air« controller

»ambient light control« (terra)
adjustment to ambient light

»presence sensor« (terra)
presence identification and automatically shutdown by presence sensor

deactivation and adjustable via control and sensor with »air« app

alto / alto side:

»air« (Bluetooth - control)
control via Occhio air App or »air« controller
switching, dimming
»color tune« (color temperature continuously adjustable)

with Mito »air« box no external dimming possible

Mito DALI box (control via DALI)

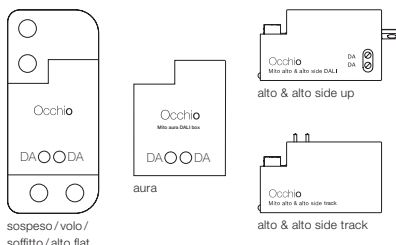

sospeso / volo / soffitto / alto flat

aura

alto & alto side up

alto & alto side track

sospeso / aura / volo:

- color tune adjustable*
- adjust continuously dimming
- up + downlight separate controllable (two DALI addresses needed)
- no »touchless control«, no fading

soffitto / alto / alto side:

- color tune adjustable*
- continuously dimming

* DALI controller DALI Device type 8 (DT8) for controlling of the color tune necessary further signs on www.occhio.com/dali

Mito volo 100 acoustic DALI connection diagram

A maximum of 32 Mito volo units can be assigned to each DALI circuit.

The Mito volo requires two DALI addresses per luminaire, which enables control of the top and bottom sides via their own respective DALI address. The maximum output is reached if both DALI luminaires (top and bottom side) are set to maximum brightness (45 W = 22 W up and 22 W down; 60 W = 30 W up and 30 W down).

The Mito volo units can be organized into as many as 16 groups and equipped with an additional 16 scenarios (predefined settings).

Using a DALI short address, they can be actuated and configured individually. In addition, the bi-directional data transfer lets users query the state/status of individual luminaires.

You can find more detailed information at www.occhio.com/dali.

