

Luna sogno datasheet

LED table luminaire with spherical head and diffuse light aimed downwards and a glass sphere diameter of 160 mm. The innovative LED fireball technology creates a special lighting effect – indirect, downward-facing and atmospheric lights of the fireball within the glass sphere.

To be connected via an external power supply plug (included) to 230 V AC mains voltage. Glass cover and fireball removable for maintenance purposes, LED interchangeable. Can be switched on and dimmed, and the color temperature can be adjusted continuously between 2700 and 4000 K (optional 2200–3500 K) using »touchless control« (gesture control on the body) or via Occhio air.

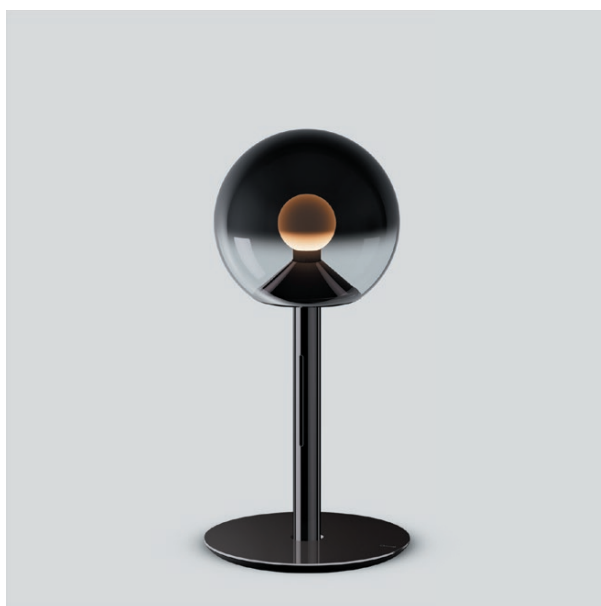

dimensions in mm

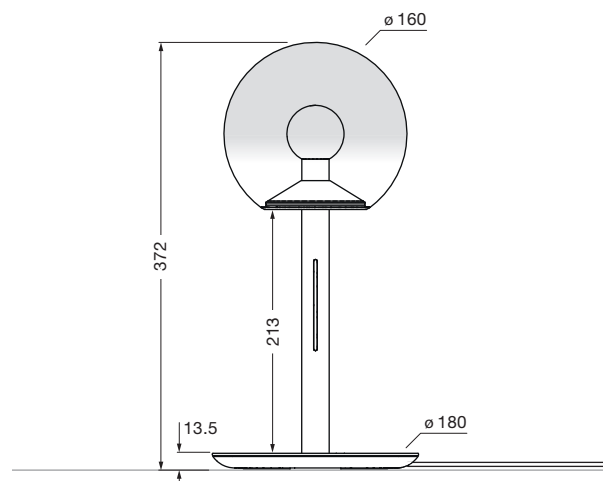

technical data Luna sogno

properties	material	aluminium, glass, PVD coated, steel, plastic
	cable length	2 m of which 1.4 m are retractable
	weight	2.7 kg
surface	head / body / base	dark chrome, phantom
	power supply	matt black
Occhio »color tune« LED	average life time	> 50.000 hrs
	energy efficiency class (luminous efficiency)	G (18 lm/W)
	power	LED 9 W (incl. Occhio power supply unit 13 W, standby < 0.5 W)
	color rendering index	CRI Ra 95
	color temperature (color consistency)	2700–4000 K (2-step) 2200–3500 K (2-step)
electricity	dimming	»touchless control«, Occhio air
	connection	230 V AC
	power factor power supply (cos φ1)	0.9
	flicker / stroboscopic effect	< 1 (PstLM) / 0.4 (SVM)
	permitted operating conditions	max. 30°C for indoor use only

Luna sogno lighting effects

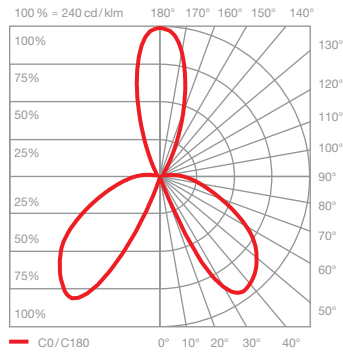

tablelight

indirect, glare-free tablelight (Occhio fireball optic)

light source: Occhio fireball

luminous flux : high color 9 W 200 lm

control options

version (»color tune«)

»touchless control« / Occhio air / phase cut dimming (switchable at power supply)

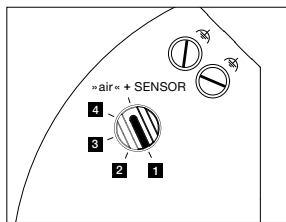

1. sospeso/piena/scura up

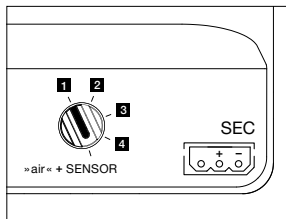

2. sospeso/piena/scura flat/sospeso pure

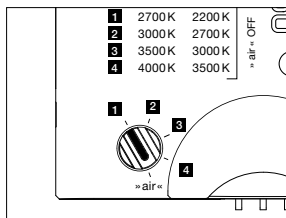

3. parete

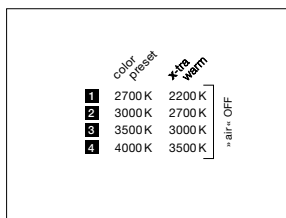

4. Possible, adjustable colour temperatures according to the selected configuration (colour preset or »x-tra warm«). touchless control and Occhio air are deactivated, trailing edge phase-cut dimming possible.

Occhio air powered by Casambi

Luna luminaires can be dimmed via »touchless control« (basso, sogno, sospeso and sospeso cloud) and Occhio air (standard for all Luna luminaires). Alternatively, dimming is possible via trailing edge phase-cut dimmer (Occhio air can be deactivated via power supply, not for basso, sogno and sospeso cloud).



Occhio air (standard)
Bluetooth control via Occhio air app or »air« controller (optional), control of individual luminaires, groups and scenes.

sospeso up (1.)
sospeso flat / pure (2.)

switch position: »air« + SENSOR
»air« + »touchless control« (Bluetooth and gesture control), control via »touchless control« and Occhio air app or »air« controller, switching, dimming, »color tune« (color temperature continuously adjustable), no external dimming possible, control and sensors can be deactivated via Occhio air app

switch position: 1 2 3 4 = »air« OFF
adjustable color temperature according to selected configuration (4 steps, see 4.), trailing-edge phase cut dimming possible, Occhio air deactivated

sospeso cloud

»air« + »touchless control« (Bluetooth and gesture control), control via »touchless control« and Occhio air app or »air« controller, switching, dimming, »color tune« (color temperature continuously adjustable according to selected configuration), no external dimming possible, control and sensors can be deactivated via Occhio air app

basso/sogno

»air« + »touchless control« (Bluetooth and gesture control), control via »touchless control« and Occhio air app or »air« controller, switching, dimming, »color tune« (color temperature continuously adjustable according to selected configuration), control and sensors can be deactivated via Occhio air app

parete (3.)

switch position: »air«
control via Occhio air app or »air« controller, switching, dimming, »color tune« (color temperature continuously adjustable), no external dimming possible

switch position: 1 2 3 4 = »air« OFF
adjustable color temperature according to selected configuration (4 steps, see 4.), trailing-edge phase cut dimming possible, Occhio air deactivated

piena/scura up (1.)
piena/scura flat (2.)

switch position: »air« + SENSOR
»air« (Bluetooth control), control via Occhio air app or »air« controller, switching, dimming, »color tune« (color temperature continuously adjustable), no external dimming possible, no gesture control for piena and scura

switch position: 1 2 3 4 = »air« OFF
adjustable color temperature according to selected configuration (4 steps, see 4.), trailing-edge phase cut dimming possible, Occhio air deactivated