

Coro piano edge pro datasheet

LED recessed spotlight with zoom optics (swivable) for hollow ceilings or solid ceilings with ceiling box. edge model with filigree ceiling edge. The spotlight is mounted with a simple tension spring mechanism and requires no screw fittings. Version with remote power supply unit, connection to external constant current power source (driver). Dimmable via customer-supplied dimmable power supply unit. The zoom optics can be rotated by 360° (with stop), swiveled by 30° and the light cone can be continuously adjusted within 25–60°.

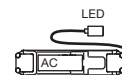
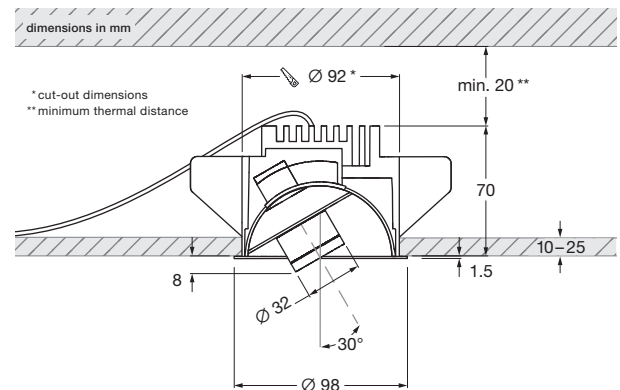
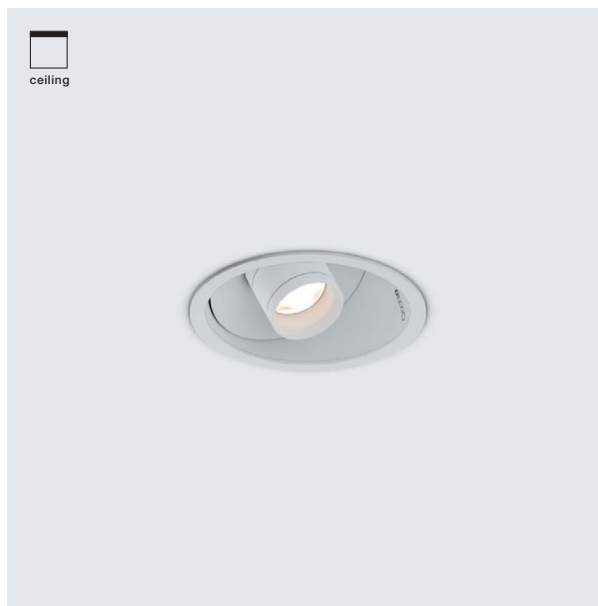

opt. third party »color tune« driver (2-channel driver with custom settings for Occhio fixtures)
L 174 x W 41 x H 29, cable length 50

technical data Coro piano edge pro

properties	material	aluminium, glass, PVD coated, painted, plastic
	turning range	360° (with stop)
	mobility head	30°
	weight	0.6 kg
surface	zoom	gold, matt gold, rose gold polished, matt silver, matt white, matt black, phantom polished, black phantom polished, dark chrome polished
	tube	matt white, matt black
Occhio LED	average life time	> 50.000 hrs
	energy efficiency class	This product contains a light source of energy efficiency class F (2200–3500 K, 2700 K, 3000 K) or E (2700–4000 K, 4000 K)
	power	LED 9W
	color rendering index	CRI Ra 92
	color temperature (color consistency)	single color: 2700 K, 3000 K, 4000 K (2-step) color tune: 2200–3500 K (2-step) 2700–4000 K (2-step)
electricity	dimming	with suitable power supply unit
	connection	single color (1-channel): max. 500 mA / 18 VDC color tune (2-channel): max. 1000 mA total current (I ₁ + I ₂) / 9 VDC per channel
	permitted operating conditions	ambient temperature 10–30°C, for indoor use only

Coro piano edge pro lighting effects

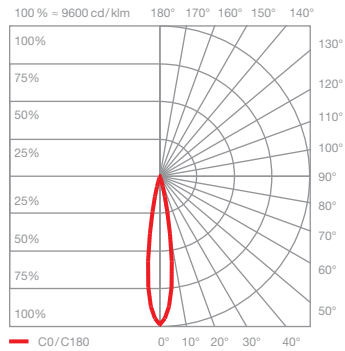
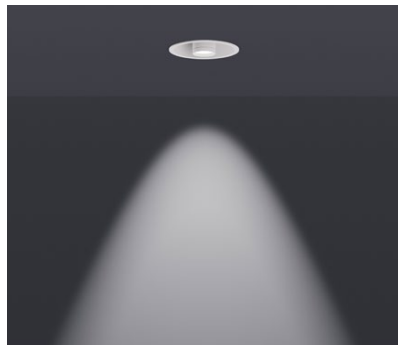

Z25
directed light (approx. 25°)

optics: zoom lens

power: high color 9W

luminous flux: 2700 K 400 lm
3000 K 420 lm
4000 K 480 lm
2200–3500 K 170–230 lm
2700–4000 K 200–240 lm

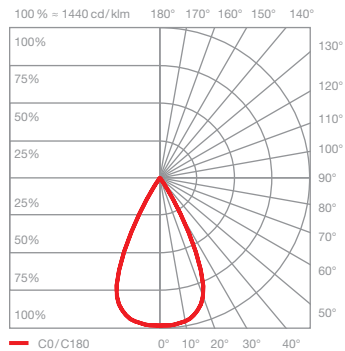
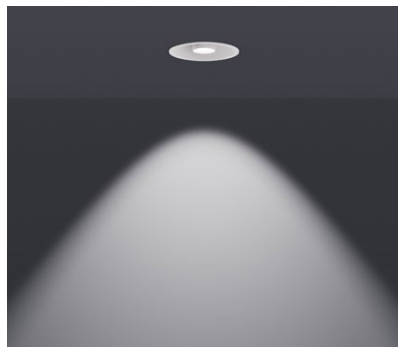

Z60
directed light (approx. 60°)

optics: zoom lens

power: high color 9W

luminous flux: 2700 K 450 lm
3000 K 480 lm
4000 K 540 lm
2200–3500 K 320–420 lm
2700–4000 K 370–450 lm