

## Coro piano cover »air« datasheet

LED recessed spotlight with zoom optic (swivable). piano version for mounting on hollow ceilings. cover model with magnetically attached decorative ring. The spotlight is mounted with a simple tension spring mechanism and requires no screw fittings. Version with remote power supply unit, connection to 230 V AC mains voltage. Switching, dimming and »color tune« via Occhio air. The color temperature can be adjusted continuously between 2700–4000 K (optional 2200–3500 K).

The zoom optic can be rotated by 360° (with end-stop), swiveled by 30° and the light cone can be adjusted continuously between 25–60°.

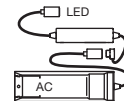
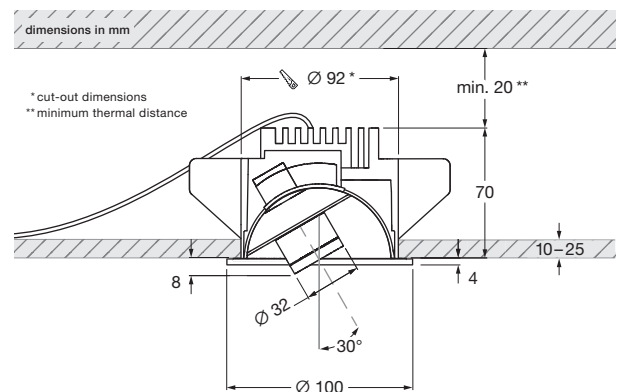
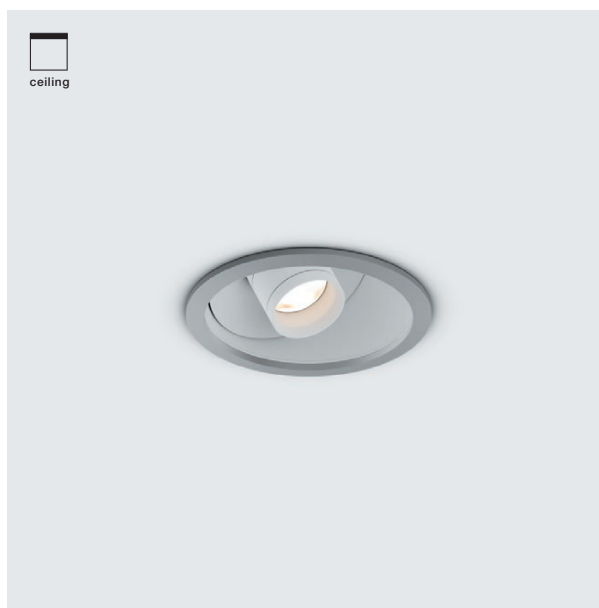

incl. flat driver »air« (removable)  
L 95 × W 23.5 × H 20 (total cable length 250)  
incl. power supply unit (removable)  
L 165 × W 50 × H 23.6 (cable length 200)

### technical data Coro piano cover »air«

properties	material	aluminium, glass, PVD coated, painted, plastic
	turning range	360° (with stop)
	mobility head	30°
	weight	0.9 kg
surface	zoom	gold, matt gold, rose gold polished, matt silver, matt white, matt black, phantom polished, black phantom polished, dark chrome polished
	tube	matt white, matt black
	cover	gold, matt gold, rose gold polished, matt silver, matt white, matt black phantom polished, black phantom polished, dark chrome polished
Occhio »color tune« LED	average life time	> 50.000 hrs
	energy efficiency class	This product contains a light source of energy efficiency class F (2200–3500K) or E (2700–4000K)
	power	LED 9 W (incl. Occhio power supply unit approx. 12 W, standby < 0.5 W)
	color rendering index	CRI Ra 92
	color temperature (color consistency)	color tune: 2200–3500 K (2-step)      2700–4000 K (2-step)
electricity	dimming	via Occhio air
	connection	230 V AC
	permitted operating conditions	ambient temperature 10–30°C, for indoor use only

## Coro piano cover »air« lighting effects

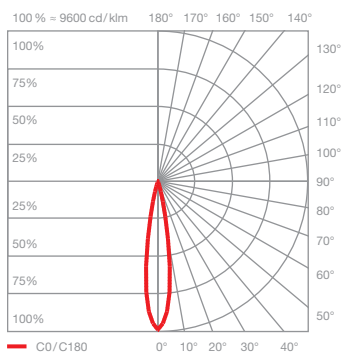
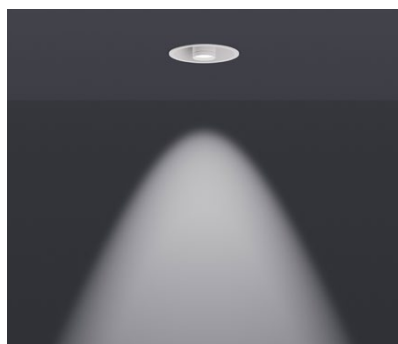

### Z25

directed light (approx. 25°)

optics: zoom lens

power: high color 9W

luminous flux: 2200–3500 K 170–230 lm  
2700–4000 K 200–240 lm

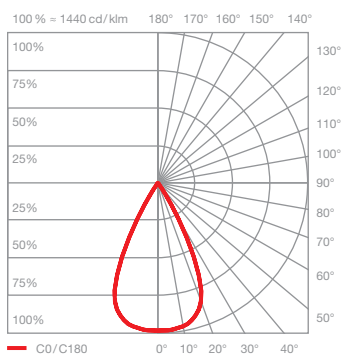
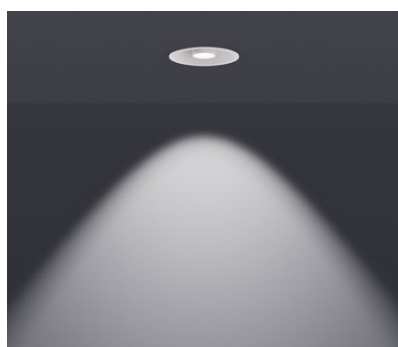

### Z60

directed light (approx. 60°)

optics: zoom lens

power: high color 9W

luminous flux: 2200–3500 K 320–420 lm  
2700–4000 K 370–450 lm